

1
2
3
4
5
6
7
8
9
10
11
12
13
14
15
16
17
18
19
20

Artificial intelligence-enabled event adjudication: estimating delayed cardiovascular effects of respiratory viruses.

Shinichi Goto^{*,1,2}, Max Homilius^{*,1,2}, Jenine E. John^{1,2}, James G. Truslow¹, Andreas A. Werdich^{1,2}, Alexander J. Blood^{1,2}, Brian H. Park^{1,2}, Calum A. MacRae^{1,2} and Rahul C. Deo^{†,1,2,3}

¹One Brave Idea and Division of Cardiovascular Medicine, Department of Medicine, Brigham and Women's Hospital, Boston, MA, USA

²Harvard Medical School, Boston, MA, USA

³Center for Digital Health Innovation and Department of Medicine, University of California San Francisco, San Francisco, CA, USA

* contributed equally

† **To whom correspondence should be addressed:**

Rahul C. Deo, MD, PhD

One Brave Idea / Division of Cardiovascular Medicine, Department of Medicine, Brigham and Women's Hospital, Boston, MA, USA

rdeo@bwh.harvard.edu

22 **Abstract**

23

24 Healthcare systems ideally should be able to draw lessons from historical data, including whether
25 common exposures are associated with adverse clinical outcomes. Unfortunately, structured
26 clinical data, such as encounter diagnostic codes in electronic health records, suffer from multiple
27 limitations and biases, limiting effective learning. We hypothesized that a machine learning
28 approach to automate ascertainment of clinical events and disease history from medical notes
29 would improve upon using structured data and enable the estimation of real-world risks. We
30 sought to test this approach to address a timely goal: estimating the delayed risk of adverse
31 cardiovascular events (i.e. after the index infection) in patients infected with respiratory viruses.
32 Using 4,151 cardiologist-labeled notes as gold standard, we trained a series of neural network
33 models to automate event adjudication for heart failure hospitalization, acute coronary syndrome,
34 stroke, and coronary revascularization and to identify past medical history for heart failure.
35 Though performance varied by task, in nearly all cases, our models surpassed the use of
36 structured data in terms of sensitivity for a given specificity level and enabled principled evaluation
37 of classification thresholds, which is typically impossible to do with diagnostic codes. Deploying
38 our models on more than 17 million notes for 267,596 patients across an extensive integrated
39 delivery network, we found that patients infected with respiratory syncytial virus had a 23%
40 increased risk of delayed heart failure hospitalization over a subsequent 4-year period compared
41 with propensity-score matched patients who had the same test but with negative results ($p = 0.003$,
42 log-rank). In contrast, we found no such increased risk in patients with a positive influenza viral
43 test compared with a negative test (rate ratio 0.98, $p = 0.71$). We conclude that convolutional
44 neural network-based models enable accurate clinical labeling at scale, thereby unlocking timely
45 insights from unstructured clinical data.

46 **Introduction**

47

48 The elusive goal of a learning healthcare system requires accurate clinical information. Structured
49 healthcare data, although increasingly accessible, suffers from biases ubiquitous in observational
50 data, including misclassification bias. In particular, diagnostic codes, widely used for billing and
51 research, typically have low sensitivity and specificity^{1,2}. When used to establish an association
52 of exposures to a clinical outcome, such limitations can lead to misclassified outcomes and
53 interfere with adjustment procedures for confounding and selection bias³.

54 Nonetheless, the detection of such associations is a priority and often requires analysis of large-
55 scale real-world data⁴. Furthermore, such observational data is often the only choice for urgent
56 clinical questions with potential public health implications. One example of such a pressing topic
57 is the cardiovascular consequences of common respiratory viruses. The immediate adverse
58 impact of respiratory viruses such as influenza, respiratory syncytial virus (RSV), and most
59 recently, severe acute respiratory syndrome coronavirus 2 (SARS-CoV-2) is well recognized and
60 includes acute heart failure^{5,6}, myocardial infarction^{7,8}, myocarditis⁹⁻¹¹, and stroke¹². However, one
61 unresolved question is whether there is a delayed increased risk in such patients well after the
62 incident infection.

63 We sought to address these questions, first developing machine learning methods to ascertain
64 and adjudicate clinical events and past medical history at scale, and then applying these to patient
65 data across multiple institutions within a large integrated delivery network.

66

67 **Results**

68

69 ***Building a large compendium of cardiologist-labeled notes***

70 The overview of our approach is shown in **Figure 1**. To train an accurate model for event
71 adjudication using medical notes, we labeled a large compendium of discharge summaries and
72 progress notes. A total of 2,967 discharge summaries (1,372 for derivation set, 592 for validation
73 set and 1,003 for test set) and 1,184 progress notes (588 for derivation set, 231 for validation set
74 and 365 for test set) were obtained from the Massachusetts General Brigham (MGB) Enterprise
75 Data Warehouse (EDW) database, which represents multiple institutions across an integrated
76 delivery network. Each discharge summary was manually annotated by cardiologists following
77 previously published guidelines for 4 possible diagnoses¹³: acute coronary syndrome (ACS), heart
78 failure (HF) as the primary cause of hospitalization, percutaneous coronary intervention or
79 coronary artery bypass graft surgery (PCI/CABG), and ischemic stroke. Progress notes were
80 labeled according to a 4-class system for heart failure history (see Methods). Discharge
81 summaries were derived from 17 different institutions while progress notes were from 46 different
82 institutions with differing levels of specialized care (**Table S1 and S2**). The labeled discharge
83 summaries were then used to train the event models and the progress notes were used to train
84 the note-level past-history model (**Figure S1**). Because single notes are not exhaustive in
85 documenting the past medical history of a patient, we developed a model that integrated the
86 output from multiple notes to estimate past-history of a specific disease at a given point in time.
87 To this end, all notes for an additional 863 patients (403 for derivation, 156 for validation and 304
88 for test) were used to label past history at a given timepoint, and were used in combination with
89 the note-level past-history model to train a patient level past-history model (**Figure S2**).

90 ***Neural network-based models have high accuracy for event adjudication***

91 We trained four event adjudication models based on a neural network architecture using the
92 labeled discharge summaries as training and testing data (**Figure S3**). The neural network-based
93 classifiers had excellent accuracy for detecting events with area under the curve of receiver
94 operating characteristics (AUC-ROC) of 0.97 (95%CI 0.95-0.98) for heart failure hospitalization,
95 1.0 (0.99-1.00) for PCI/CABG, 0.97 (0.95-0.98) for ACS and 0.98 (0.97-0.99) for ischemic stroke
96 (**Figure 2**). In comparison, structured diagnostic data (ICD-10 codes for ACS/HF/IS and Current
97 Procedural Terminology (CPT) codes for PCI/CABG) had excellent specificity but only modest
98 sensitivity with the exception of ischemic stroke, for which diagnostic codes had excellent

99 sensitivity for the notes we examined (**Table 1**). The good performance of the ICD-10 codes for
100 stroke may be attributable to the fact that most of the stroke cases we considered were admitted
101 to neurology intensive care units, which may not be the case at other institutions/settings. Overall,
102 our models were able to provide increased sensitivity at a 90% specificity threshold for events
103 (**Table 2**). Based on these results, we predicted events based on our event adjudication models
104 for HF hospitalization, PCI/CABG and ACS and used ICD-10 codes to define ischemic stroke
105 events.

106

107 ***Patients positive for respiratory syncytial virus infection have a higher risk***
108 ***of subsequent heart failure hospitalization compared with those with***
109 ***negative results***

110 A scalable method of accurate event adjudication enables a breadth of downstream applications
111 of clinical and economic value to hospital systems and public health measures. We focused on a
112 timely area, the association of respiratory virus infection with remote cardiovascular events. Using
113 data from the MGB EDW, we identified 267,596 patients with diagnostic test results for a
114 respiratory virus. Of these, we first focused on the 57,828 patients with respiratory syncytial virus
115 (RSV) diagnostic test results, out of which 35,056, 35,828 and 35,778 patients were included in
116 the final cohort for predicting heart failure hospitalization, urgent revascularization and ischemic
117 stroke analysis respectively (**Figure S4-S6**).

118 By selecting patients based on having undergone a viral test, we introduced possible selection
119 (collider) bias¹⁴, given that clinical suspicion for a respiratory virus implies an increased likelihood
120 of a cardiopulmonary etiology (**Figure S7**). We thus used propensity-score matching to identify
121 patients with a negative test result but with a similar probability of having a positive result for viral
122 infection, as judged by values of other clinical (confounding) variables¹⁵. Propensity-score
123 matching with 1:16 ratio resulted in well-balanced baseline characteristics between RSV positive
124 and negative patients for all 3 outcomes (standardized mean difference <0.1 for all characteristics,
125 **Tables S3-S8**). To focus on delayed outcomes rather than acute outcomes, we defined events
126 as occurring at least 30 days after the test result was obtained (and matched patients by
127 comorbidities up to that point). RSV positive patients had an event rate of 10.5/100 person-years
128 of heart failure hospitalization which was significantly higher compared to those with negative
129 results who had an event rate of 8.6/100 person-years (n=26,027, median follow-up 368 days, p
130 = 0.0032, **Figure 3 upper panel**). There was no significant difference between RSV positive

131 patients and negative patients for urgent revascularization, defined as the conjunction of a
132 diagnosis of acute coronary syndrome and either PCI or CABG (n=26,724, median follow-up 388
133 days, 0.8/100 person-years for test positive patients and 0.7/100 person-years for test negative
134 patients, p = 0.49) and ischemic stroke (n=26,690, median follow-up 389 days, 1.1/100 person-
135 years for test positive and 0.9/100 person-years for test negative, p = 0.46). To evaluate if this
136 analysis was driven mostly by early events, we restricted events to those occurring at least 90
137 days after the test result (patient selection and baseline characteristics shown in **Figures S8-S10**
138 and **Tables S9-14**). This sensitivity analysis showed similar results with a longer median follow-
139 up period of 418, 444 and 442 days for heart failure hospitalization, urgent revascularization and
140 ischemic stroke, respectively, suggesting that our results are driven by delayed events rather than
141 acute events (**Figure S11 upper panel**).

142 ***Patients positive for influenza virus infection do not have an increased risk***
143 ***of delayed cardiovascular events compared to those with negative results***

144 We identified 81,250 patients with influenza test results, of which 58,522, 59,594 and 59,523
145 patients were included in the final cohort for heart failure hospitalization, urgent revascularization,
146 and ischemic stroke, respectively (**Figure S12-S14**). As for RSV, we used propensity-score
147 matching to adjust for differences in baseline characteristics between the virus positive and
148 negative population. This matching procedure resulted in 1:5 matching between influenza positive
149 and negative patients for all 3 outcomes (standardized mean difference <0.1, **Tables S15-S20**).
150 In contrast to the RSV virus, there were no significant differences between influenza positive
151 patients and negative patients for delayed heart failure hospitalization (n=30,828, median follow-
152 up 614 days, 2.8/100 person-years for test positive and 2.9/100 person-years for test negative, p
153 = 0.71), urgent revascularization (n=31,056, median follow-up 643 days, 0.3/100 person-years for
154 test positive and 0.3/100 person-years for test negative, p = 0.62) or ischemic stroke (n=31,032,
155 median follow-up 653 days, 0.5/100 person-years for test positive and 0.5/100 person-years for
156 test negative, p = 0.62, **Figure 3 lower panel**). As with RSV, we also performed an analysis by
157 using 90 days as the early event exclusion period (patient selection and baselines shown in
158 **Figures S15-S17** and **Tables 21-26**). The results were similar to the main analysis with median
159 follow up period of 670, 682 and 653 days for heart failure hospitalization, urgent revascularization
160 and ischemic stroke, respectively (**Figure S11 lower panel**).

161 ***Sensitivity analysis using a neural network-based model for heart failure***
162 ***history shows robustness of results***

163 The past medical history of heart failure used for propensity-score matching was derived from an
164 aggregate use of ICD-10 codes from problem lists, encounter diagnoses, medical history, and
165 admission diagnoses. Given concern for inaccuracy of structured data, our finding that RSV
166 infection was associated with higher rate of heart failure hospitalization may have been affected
167 by the definition of HF history (which has large impact on this outcome). To overcome this concern,
168 we first sought to evaluate the accuracy of the ICD-10 code-based approach to define HF history.
169 To this end, we performed a systematic effort of labeling 863 patients and found that the ICD-10
170 approach nonetheless had a good accuracy with sensitivity 0.80 and specificity 0.97 (**Figure 4A**).
171 Although the performance was good, the use of structured data typically leaves no flexibility to
172 explore robustness of the result to different thresholds. We were particularly concerned about the
173 impact of a reduced sensitivity. Therefore, we developed a neural network-based approach for
174 learning past medical history at a given point in time using a neural network-based strategy. We
175 trained three separate models: a model for note-informativeness, a model for heart failure history
176 classification, and finally a time series model that used an aggregate of note scores across time.
177 The final model had an excellent discriminative ability with ROC-AUC of 0.97 (**Figure 4A**).
178 Although the accuracy at the mandatory point of comparison was not superior to the ICD-10 code-
179 based definition, the model enabled evaluating robustness of the results to the selected cutoff
180 point. We assessed conclusions using cutoffs with high sensitivity, high specificity and a balanced
181 sensitivity/specificity ratio. Different cutoffs gave different absolute rates of heart failure history
182 (**Table S26**). Nonetheless, propensity score matching using model-based heart failure history was
183 successful with SMD<0.1 for all baseline values (**Table S27-32**) and the overall results were
184 unchanged for the association of heart failure hospitalization with viral infection, with p-values
185 ranging from 0.0030 to 0.0043 for RSV and 0.28 to 0.70 for influenza (**Figure 4B**).

186

187

188 Discussion

189

190 Here we outline two primary contributions; 1) machine learning models for automated event
191 adjudication for cardiovascular events and past medical history and 2) application of these models
192 to estimate the risk of delayed heart failure hospitalizations in individuals with respiratory virus
193 infections. In this context, we observed an estimated 23% higher risk of delayed heart failure
194 hospitalizations in individuals infected with RSV compared to those who tested negative but no
195 change in the risk for such events following influenza infection.

196 Our work labeling a large collection of notes across over 17 institutions within an integrated
197 delivery network adds further support to the limitations of diagnostic codes for describing
198 cardiovascular events². The accuracy of diagnostic codes varied strongly with the type of event:
199 at one extreme, ischemic stroke was very well captured whereas there were no clear diagnostic
200 codes for coronary revascularization, and, at least within our database, the use of CPT codes had
201 very low sensitivity. Reimbursement incentives are known to shape the completeness of
202 diagnostic codes¹⁶ and there is also further variation from center to center based on provider and
203 institutional coding practices. Nonetheless, a systematic labeling approach can provide local
204 estimates of the adequacy of diagnostic code for any specific application, and further simulation-
205 based modeling can be used to understand the impact of misclassification bias on any
206 downstream uses of the data.

207 Although we found that a historical compilation encompassing encounter diagnoses, admission
208 diagnoses, problem lists, and medical history is highly accurate, at least for heart failure, the
209 sensitivity was relatively low compared to specificity, which is in agreement with previous studies
210 showing that ICD-10 codes for past medical history suffers primarily from problems of sensitivity¹⁷.
211 The ICD-10 code-based approach forces a single sensitivity/specificity and does not allow
212 adjustment or optimization. In comparison, our model-based definition can provide various
213 sensitivity/specificity ratio by adjusting the threshold. This feature enabled us to perform a
214 sensitivity analysis showing that our results are robust to the sensitivity/specificity of the past
215 medical history detection. Furthermore, we anticipate that our approach should generalize well to
216 capturing conditions for which there are no diagnostic codes (such as inadequate response to a
217 medication).

218 In terms of prior work, most of the focus on EHR-based automated diagnoses has been on the
219 use of heuristic combinations of diagnostic codes, medications, labs, and regular expression

220 matching within unstructured data². Recent advances in convolutional neural network-based text
221 processing have motivated their application to the problem of note classification^{18,19}. Our own
222 experience with this process emphasized the need for both domain (i.e., cardiovascular disease)
223 and data science expertise, with an iterative examination of failure cases, augmented labeling,
224 and retraining of models.

225 Our models enabled scalable analysis of millions of discharge summaries and progress notes.
226 We see multiple applications of such an approach, whether it be for pharmacovigilance, quality
227 control, or patient selection for a clinical trial according to criteria that may be poorly reflected in
228 structured data. For our specific application, we were able to conclude that influenza virus
229 infection does not appear to contribute to any delayed increase in heart failure hospitalization,
230 while RSV infection contributes a 23% increase in risk that is apparent across an entire four-year
231 period.

232 Prior work focusing on respiratory viruses have emphasized the acute cardiovascular
233 manifestations of viral infections in a limited subset of patients^{5,20}. In the case of RSV, it is well
234 recognized that patients with RSV infections have a higher burden of cardiovascular disease,
235 although this may reflect selection bias, given that cardiovascular consequences of viral infection
236 may add to pre-existing disease to drive presentation to healthcare systems. However, our results
237 are striking in that even controlling for heart failure diagnoses prior to and up to 90 days after the
238 incident event, we still see an increased risk of future events. While previous reports show
239 increased risk of cardiovascular events in patients with influenza infections, they focus entirely on
240 acute events in the context of the infection⁶⁻⁸. Our analysis excludes acute events and thus, does
241 not contradict these findings. It is entirely plausible that influenza virus increases heart failure
242 hospitalization in the acute phase, either through direct myocardial involvement²¹ or indirectly
243 through a systemic inflammatory response as with many other infections²², but patients may not
244 have prolonged damage to the heart.

245 The primary limitation of our work is the unknown contribution of unmeasured confounders with
246 significant impact on both heart failure hospitalization outcomes and probability of positive test for
247 viral infection. Since our analysis focused only on those who had been tested for the virus, these
248 population likely had symptoms suggestive of a cardiopulmonary illness. Thus, the negative
249 results for the virus results may be consistent with other reasons for having respiratory symptoms.
250 In the case of influenza virus, we observed a classic example of collider bias requiring propensity
251 score matching approaches²³. Nonetheless, such approaches inevitably can suffer from model
252 misspecification. However, it should be noted that possible approaches to address these

253 limitations such as randomizing patients to be infected by a virus or performing a cohort study
254 testing every individual regardless of the symptoms are not feasible.

255 An open question is whether our work has relevance to other respiratory viruses, such as SARS-
256 COV2. Although SARS-COV2, like influenza²¹ and RSV, can cause myocarditis^{9-11,24}, there is no
257 clarity on the prevalence of this effect given the selection bias in published reports. Nonetheless,
258 it is reasonable to assume the possibility of long-term cardiac consequences for SARS-COV2,
259 that will only be addressed with multi-year surveillance and methodologic approaches such as
260 our own.

261

262

263

264

265 **Methods**

266

267 ***Ethics statement***

268 Institutional review board approval was obtained for all aspects of this study,

269 ***Selection and labeling of clinical notes for event model training and*** 270 ***evaluation***

271 The Massachusetts General Brigham (MGB) Electronic Data Warehouse (EDW), which includes
272 notes from >20 provider locations across a large integrated delivery network, was the source of
273 notes and structured clinical data used in this study. Two sets of discharge summaries were used
274 for model training and testing. The training set, consisting of 1964 discharge summaries, were
275 partially enriched with the use of ICD10 codes for stroke, myocardial infarction, and heart failure.
276 The test set, consisting of 1,003 discharge summaries, was selected randomly from patients
277 above who had undergone electrocardiograms within the centers participating in the EDW.

278 Following previously published guideline¹³, one of 4 cardiologists labeled each discharge
279 summary for 4 possible diagnoses: acute coronary syndrome, heart failure as the primary cause
280 of hospitalization, percutaneous coronary intervention or coronary artery bypass surgery
281 (PCI/CABG), or ischemic stroke.

282 ***Processing of clinical notes***

283 We used SpaCy v2.2.4²⁵ to tokenize medical notes. We extended the English language model
284 (en-core-web-large) tokenization rules by adding a comprehensive set of abbreviations that are
285 commonly used in medical records. We used fasttext v0.9.2²⁶ to train 100-dimensional bigram
286 word embeddings with the parameters `fasttext skipgram -wordNgrams 2`. Word embeddings
287 were trained on a compendium of more than 10 million clinical notes ranging from 2002 to 2020,
288 based on more than 330,000 subjects, with up to 50 notes per subject.

289 ***Training of event adjudication models***

290 The event adjudication model was constructed with the combination of 1D-CNN and long-short-
291 term memory (LSTM). It consisted of a word embedding layer, which converts words into word
292 vectors, followed by a 1D-CNN and LSTM combination network (schematic shown in **Figure S1**).
293 The model was trained using data from derivation dataset. Each discharge summary was labeled
294 as positive or negative for 4 outcomes of interest (heart failure hospitalization, PCI/CABG, ACS
295 and ischemic stroke) and 4 separate models were trained for each outcome label. The model was

296 trained to minimize the binary cross entropy between model prediction and the label using
297 RMSprop optimizer with initial learning rate of 0.0001. The model was trained for 150 epochs. At
298 the end of each epoch, ROC-AUC on the validation dataset was calculated. The final model was
299 chosen as the model with highest ROC-AUC on the validation cohort across all 150 epochs.

300 ***Selection of test results for respiratory virus infection***

301 Using a data dictionary, we identified identifiers for diagnostic tests for influenza A and B,
302 parainfluenza, respiratory syncytial virus (RSV), coronavirus, and adenovirus and downloaded all
303 relevant viral test results within the MGB-EDW. We limited analysis to tests having at least 5000
304 patients. The test results were reported as free text. While most results were reported simply as
305 positive or negative, in some cases, the descriptions of the viral test results were complex.
306 Therefore, a physician (SG) reviewed all possible texts in the report and compiled a conversion
307 table from the texts to positive/negative results. Since comprehensive reporting in the EDW
308 started on Feb 2016, we included only results after that date.

309 ***Survival analysis for cardiovascular events***

310 To evaluate the influence of viral infection on 3 cardiovascular events (heart failure hospitalization,
311 urgent revascularization and ischemic stroke), we performed a survival analysis for these
312 outcomes. Due to limited numbers or follow-up length for other viruses, we focused our analysis
313 on influenza and RSV. To avoid possible bias caused by the COVID-19 outbreak in Boston area,
314 all the follow up were censored at February 2020. All viral test results between February 2016
315 and February 2020 were identified. Positive patients were identified as those having at least one
316 positive result for the virus of interest within the study period and the date of first positive result
317 was used as the index date. Patients who had the test for the virus of interest but did not have
318 any positive results were identified as a control population within that cohort. Index dates were
319 identified as the date of first viral test for control patients. All patients who had other viral infections
320 before the index date were excluded.

321 Outcome events were defined bases on the event text model predictions for heart failure
322 hospitalization and urgent revascularization and ICD-10 codes for ischemic stroke. The cutoffs
323 for the events were selected as the value that gave the best sensitivity at a specificity over 90%.
324 Urgent revascularization was defined as positive results for PCI/CABG and ACS for the same
325 discharge summary. All 3 outcome events were analyzed independently. Patients were censored
326 at the first event, death, last encounter in the system or the end of study period, whichever
327 occurred first. To account for confounders, we used a propensity-score matching method¹⁵. A

328 propensity score for a positive test was calculated with age, sex, race, smoking status, history of
329 heart failure, history of coronary artery disease, history of atrial fibrillation, history of type 2
330 diabetes mellitus, history of COPD, history of hypertension, history of dyslipidemia, use of loop
331 diuretic, use of aspirin, use of P2Y₁₂ inhibitors and the method for viral test using logistic
332 regression. In this analysis, the past histories were identified using ICD-10 codes. The between
333 group difference in baseline characteristics was assessed by the standardized mean difference
334 (SMD) where a value under 0.1 is considered negligible. Patients with positive viral results were
335 matched to controls (without replacement) using a nearest neighbor method, as implemented in
336 the *MatchIt* package (version 3.0.2) in *R* (version 3.5.1)²⁷. The matching ratio was set to the
337 highest number that did not introduce substantial difference in any baseline characteristics
338 (SMD<0.1).

339 ***Training and testing of a past medical history model***

340 Since past medical history is defined using a cumulative record and not on a single note, we took
341 a 2-step approach for training the history model. Our first step focused on classifying the note.
342 Since some notes are totally unrelated to the history of disease (such as nutrition notes), we
343 trained a model to classify if the note is informative for a specific history or not and a second
344 model to actually classify if the history is positive or negative. To this end, each note was initially
345 labeled with 3 labels (positive/negative and uninformative). During labeling, we also noticed that
346 there were some notes that stated an ambiguous condition (e.g. extremely low ejection fraction
347 without noting if the patient have symptoms or not for heart failure). We labeled these by a 4th
348 label (ambiguous) and excluded these from the training data. Two sets of notes were used for
349 model training and testing from the MGB-EDW database where the training set were partially
350 enriched with the use of ICD10 codes heart failure and the test set selected randomly. The final
351 numbers of notes were 819 for training set and 365 for the test set. The note-level models resulted
352 in note-level accuracy of AUC 0.93 for informativeness and 0.93 for the presence of heart failure
353 history (**Figure S2A**).

354 The second step focused on combining all the note-level output to identify the past medical history
355 status for each patient for a specific date. To this end, we built a time-series neural network-model
356 that takes note-level prediction for informativeness and past medical history status along with the
357 dates of the note relative to the index date as input. The model produces a single binary output
358 reflecting the probability of the patient having the disease history at the index date (**Figure S2B**).
359 For this model, we labeled a separate patient dataset (with no overlap with the note level history
360 model patients) consisting of 561 patient-date pairs for training and 305 patient-date pairs for

361 testing. The patients in the training datasets were partially enriched for past medical history using
362 the event adjudication model to select patients who had an event before the index date. In contrast,
363 the patients in test set were randomly selected from a group of patients 60 years and above who
364 had received an electrocardiogram at MGB. The labeling was done by reading all the notes
365 associated with that patient to identify if the patient had a positive history of the disease at the
366 index date. The input data was constructed as time-series data of the note-level output for all the
367 notes within ± 2500 days of index date. Each output value was inserted into a vector of length
368 5000 (each element corresponding to the date relative to index date). The neural network was
369 trained to take this vector as input and a binary 1/0 value as output.

370 ***Sensitivity analysis with various thresholds for heart failure history***

371 To evaluate if the results of our survival analysis was sensitive to the sensitivity/specificity of the
372 past medical history detection method, repeated the survival analysis for heart failure
373 hospitalization using the heart failure history defined based on the time-series history model with
374 various cutoff points. We used 3 cutoff points for this analysis, each of which giving (1) highest
375 specificity with sensitivity ≥ 0.95 , (2) sensitivity and specificity both over > 0.90 , (3) highest
376 sensitivity with specificity ≥ 0.95 . The cutoffs were 0.24 (sensitivity=0.96, specificity=0.83), 0.41
377 (sensitivity=0.90, specificity=0.93) and 0.43 (sensitivity=0.68, specificity=0.98). The propensity
378 score matching was re-done using the model-based heart failure history instead of ICD-10 code-
379 based heart failure history.

380

381

382 References

383

- 384 1. O'Malley KJ, Cook KF, Price MD, Wildes KR, Hurdle JF, Ashton CM. Measuring Diagnoses:
385 ICD Code Accuracy. *Health Serv Res.* 2005;40:1620–1639.
- 386 2. Wei W-Q, Teixeira PL, Mo H, Cronin RM, Warner JL, Denny JC. Combining billing codes,
387 clinical notes, and medications from electronic health records provides superior phenotyping
388 performance. *J Am Med Inform Assn.* 2016;23:e20–e27.
- 389 3. Lash TL, Fox MP, MacLehose RF, Maldonado G, McCandless LC, Greenland S. Good practices
390 for quantitative bias analysis. *Int J Epidemiol.* 2014;43:1969–1985.
- 391 4. Patadia VK, Coloma P, Schuemie MJ, Herings R, Gini R, Mazzaglia G, Picelli G, Fornari C,
392 Pedersen L, Lei J van der, Sturkenboom M, Trifirò G, consortium E-A. Using real-world
393 healthcare data for pharmacovigilance signal detection – the experience of the EU-ADR project.
394 *Expert Rev Clin Phar.* 2014;8:95–102.
- 395 5. Falsey AR, Hennessey PA, Formica MA, Cox C, Walsh EE. Respiratory Syncytial Virus
396 Infection in Elderly and High-Risk Adults. *New Engl J Med.* 2005;352:1749–1759.
- 397 6. Kytömaa S, Hegde S, Claggett B, Udell JA, Rosamond W, Temte J, Nichol K, Wright JD,
398 Solomon SD, Vardeny O. Association of Influenza-like Illness Activity With Hospitalizations for
399 Heart Failure. *Jama Cardiol.* 2019;4:363–369.
- 400 7. Kwong JC, Schwartz KL, Campitelli MA, Chung H, Crowcroft NS, Karnauchow T, Katz K, Ko
401 DT, McGeer AJ, McNally D, Richardson DC, Rosella LC, Simor A, Smieja M, Zahariadis G,
402 Gubbay JB. Acute Myocardial Infarction after Laboratory-Confirmed Influenza Infection. *New*
403 *Engl J Medicine.* 2018;378:345–353.
- 404 8. Barnes M, Heywood AE, Mahimbo A, Rahman B, Newall AT, Macintyre CR. Acute myocardial
405 infarction and influenza: a meta-analysis of case–control studies. *Heart.* 2015;101:1738.
- 406 9. Inciardi RM, Lupi L, Zaccone G, Italia L, Raffo M, Tomasoni D, Cani DS, Cerini M, Farina D,
407 Gavazzi E, Maroldi R, Adamo M, Ammirati E, Sinagra G, Lombardi CM, Metra M. Cardiac
408 Involvement in a Patient With Coronavirus Disease 2019 (COVID-19). *Jama Cardiol.*
409 2020;5:819–824.
- 410 10. Doyen D, Mocerri P, Ducreux D, Dellamonica J. Myocarditis in a patient with COVID-19: a
411 cause of raised troponin and ECG changes. *Lancet.* 2020;395:1516.
- 412 11. Madjid M, Safavi-Naeini P, Solomon SD, Vardeny O. Potential Effects of Coronaviruses on
413 the Cardiovascular System. *Jama Cardiol.* 2020;5:831–840.

- 414 12. Boehme AK, Luna J, Kulick ER, Kamel H, Elkind MSV. Influenza-like illness as a trigger for
415 ischemic stroke. *Ann Clin Transl Neur*. 2018;5:456–463.
- 416 13. Hicks KA, Mahaffey KW, Mehran R, Nissen SE, Wiviott SD, Dunn B, Solomon SD, Marler
417 JR, Teerlink JR, Farb A, Morrow DA, Targum SL, Sila CA, Hai MTT, Jaff MR, Joffe HV, Cutlip
418 DE, Desai AS, Lewis EF, Gibson CM, Landray MJ, Lincoff AM, White CJ, Brooks SS, Rosenfield
419 K, Domanski MJ, Lansky AJ, McMurray JJV, Tcheng JE, Steinhubl SR, Burton P, Mauri L,
420 O'Connor CM, Pfeffer MA, Hung HMJ, Stockbridge NL, Chaitman BR, Temple RJ, (SCTI) SDC
421 for CTI. 2017 Cardiovascular and Stroke Endpoint Definitions for Clinical Trials. *Circulation*.
422 2018;137:961–972.
- 423 14. Berkson J. Limitations of the Application of Fourfold Table Analysis to Hospital Data., *Int J*
424 *Epidemiol*. 2014;43:511–515.
- 425 15. Rosenbaum PR, Rubin DB. Assessing Sensitivity to an Unobserved Binary Covariate in an
426 Observational Study with Binary Outcome. *J Royal Statistical Soc Ser B Methodol*. 1983;45:212–
427 218.
- 428 16. Dafny LS. How Do Hospitals Respond to Price Changes? *Am Econ Rev*. 2005;95:1525–1547.
- 429 17. Hripcsak G, Albers DJ. Next-generation phenotyping of electronic health records. *J Am Med*
430 *Inform Assn*. 2012;20:117–121.
- 431 18. Usama M, Ahmad B, Wan J, Hossain MS, Alhamid MF, Hossain MA. Deep Feature Learning
432 for Disease Risk Assessment Based on Convolutional Neural Network With Intra-Layer Recurrent
433 Connection by Using Hospital Big Data. *Ieee Access*. 2018;6:67927–67939.
- 434 19. Magna AAR, Allende-Cid H, Taramasco C, Becerra C, Figueroa RL. Application of Machine
435 Learning and Word Embeddings in the Classification of Cancer Diagnosis Using Patient
436 Anamnesis. *Ieee Access*. 2020;8:106198–106213.
- 437 20. Ivey KS, Edwards KM, Talbot HK. Respiratory Syncytial Virus and Associations With
438 Cardiovascular Disease in Adults. *J Am Coll Cardiol*. 2018;71:1574–1583.
- 439 21. Ukimura A, Satomi H, Ooi Y, Kanzaki Y. Myocarditis Associated with Influenza A
440 H1N1pdm2009. *Influ Res Treat*. 2012;2012:351979.
- 441 22. Drozd M, Garland E, Walker AMN, Slater TA, Koshy A, Straw S, Gierula J, Paton M, Lowry
442 J, Sapsford R, Witte KK, Kearney MT, Cubbon RM. Infection-Related Hospitalization in Heart
443 Failure With Reduced Ejection Fraction. *Circulation Hear Fail*. 2020;13:e006746.
- 444 23. Hernán MA, Hernández-Díaz S, Robins JM. A Structural Approach to Selection Bias.
445 *Epidemiology*. 2004;15:615–625.

- 446 24. Shi S, Qin M, Shen B, Cai Y, Liu T, Yang F, Gong W, Liu X, Liang J, Zhao Q, Huang H,
447 Yang B, Huang C. Association of Cardiac Injury With Mortality in Hospitalized Patients With
448 COVID-19 in Wuhan, China. *Jama Cardiol.* 2020;5:802–810.
- 449 25. Honnibal M, Montani I. SpaCy 2: Natural language understanding with bloom embeddings,
450 convolutional neural networks and incremental parsing. *To appear.* 2017;7.
- 451 26. Bojanowski P, Grave E, Joulin A, Mikolov T. Enriching word vectors with subword
452 information. *Transactions of the Association for Computational Linguistics.* 2017;5:135--146.
- 453 27. Ho DE, Imai K, King G, Stuart EA. Matching as Nonparametric Preprocessing for Reducing
454 Model Dependence in Parametric Causal Inference. *Polit Anal.* 2007;15:199–236.
- 455

Figures

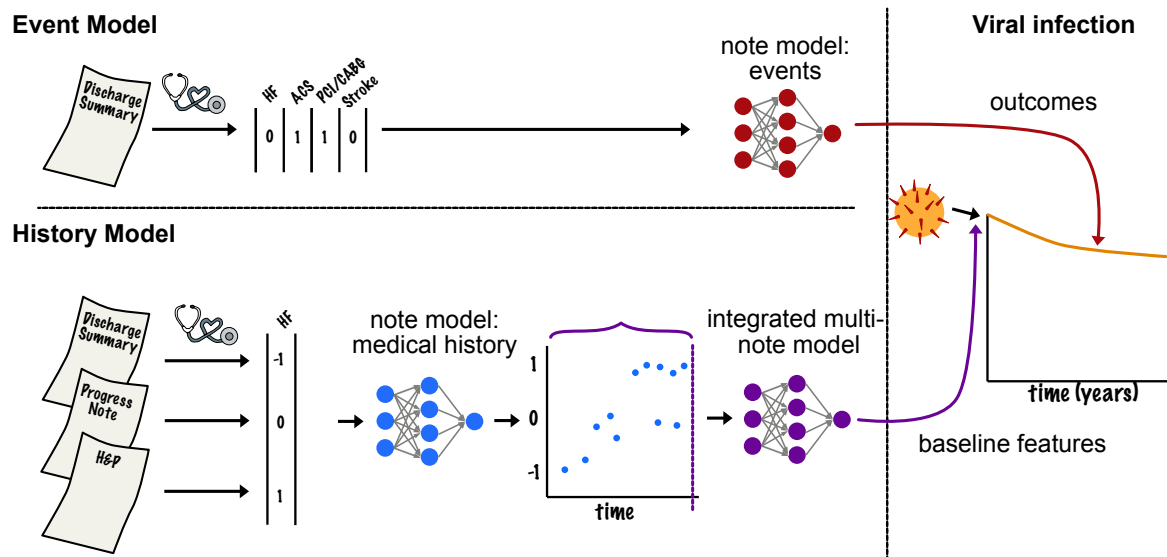

Figure 1. Schematic illustration of the study flow.

A large compendium of cardiologist-labeled discharge summaries and progress notes were used to train four cardiovascular event adjudication models and a heart failure history model using neural networks. The models were deployed on 17 million notes for 267,596 patients to evaluate the impact of respiratory virus infections on delayed cardiovascular events.

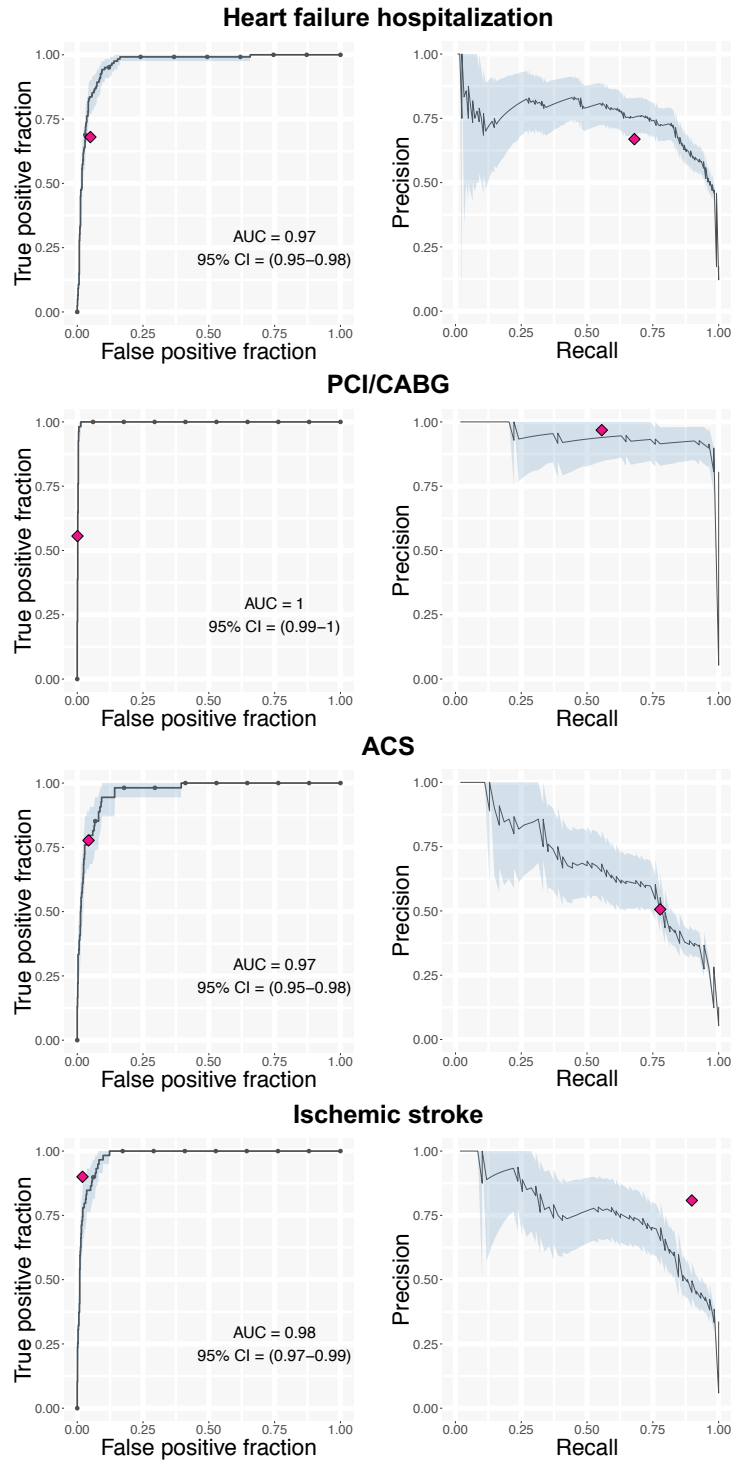

Figure 2. Accuracy of event adjudication model to classify hospitalized events.

Receiver operating characteristics curves (left) and precision-recall curves (right) for event adjudication models for PCI/CABG, ACS, heart failure hospitalization and ischemic stroke in the test dataset. Light blue area indicates 95% confidence interval and the pink diamond indicates the sensitivity and specificities of the ICD-10 code-based diagnosis.

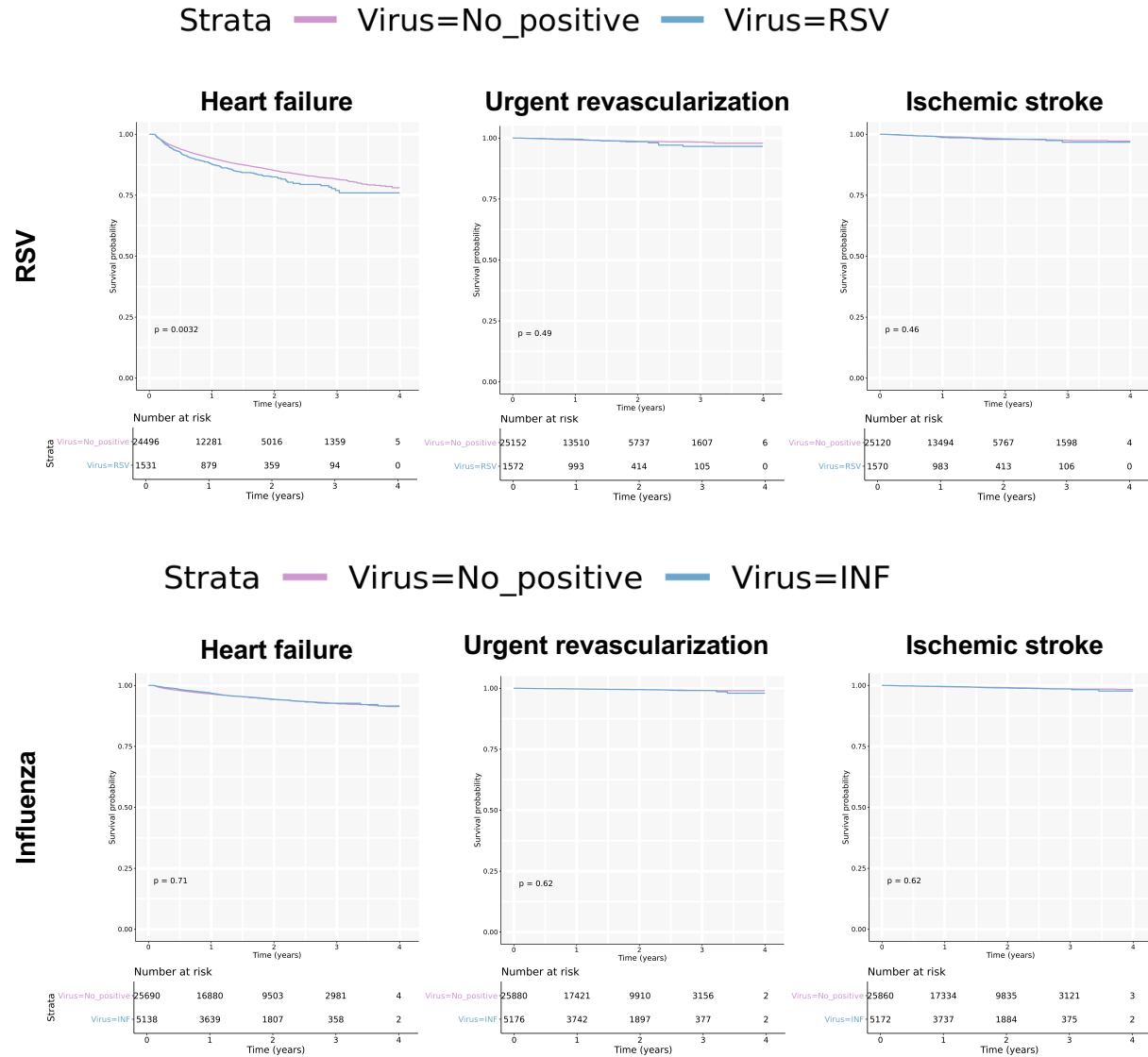

Figure 3. Survival analysis for RSV and influenza infection on cardiovascular events.

Kaplan-Meier plot comparing event rates of heart failure hospitalization, urgent revascularization and ischemic stroke in virus positive and negative population for RSV and influenza. Abbreviations, RSV: respiratory syncytial virus, INF: influenza virus.

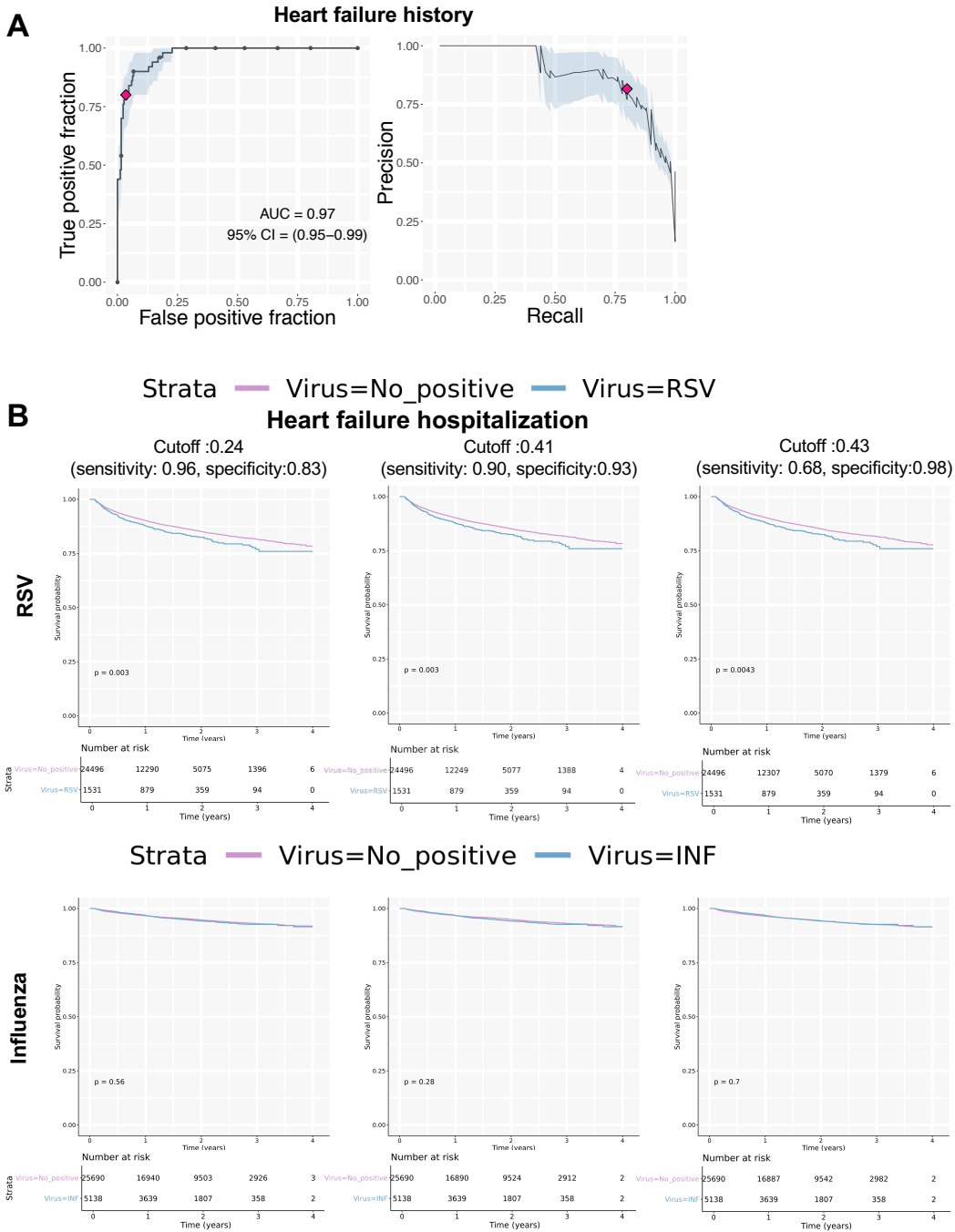

Figure 4. Sensitivity analysis evaluating different thresholds for a past medical history of heart failure on the risk of heart failure hospitalization with viral infection.

(A) Receiver operating characteristics curves for the heart failure past medical history model. (B) Kaplan-Meier plot comparing event rates of heart failure hospitalization in virus positive and negative populations for RSV and influenza with various cutoffs for heart failure history. Sensitivity and specificity for detecting heart failure histories with the corresponding cutoffs are shown. Abbreviations, RSV: respiratory syncytial virus, INF: influenza virus.

Tables

Table 1. Sensitivity and specificity of ICD-10 code

Model	Sensitivity	Specificity
PCI/CABG	0.30	1.00
ACS	0.78	0.95
Heart failure hospitalization	0.68	0.95
Ischemic stroke	0.95	0.93

Table 2. Cutoffs, sensitivity and specificity of the event adjudication model

Model	Cutoff used for survival analysis	Sensitivity (95% CI)	Specificity (95% CI)
PCI/CABG	0.73	1.00 (1.00-1.00)	0.99 (0.98-1.00)
ACS	0.04	0.91 (0.83-0.98)	0.91 (0.89-0.93)
Heart failure hospitalization	0.12	0.94 (0.90-0.98)	0.91 (0.89-0.93)
Ischemic stroke	0.59	0.98 (0.95-1.00)	0.90 (0.88-0.92)

Supplementary Figures

A

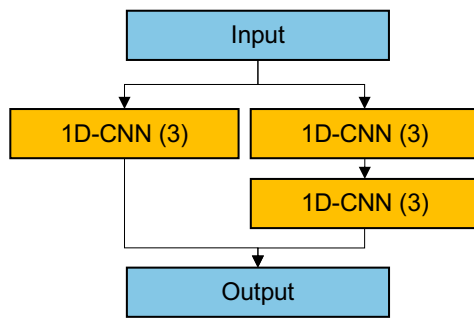

B

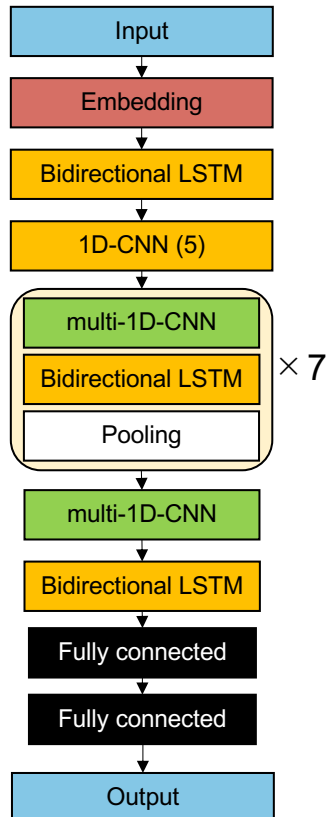

Figure S1: Schematic drawing of the network structure of the event adjudication model.

(A) Structure of the multi-1D-CNN module and (B) the full network structure of the model

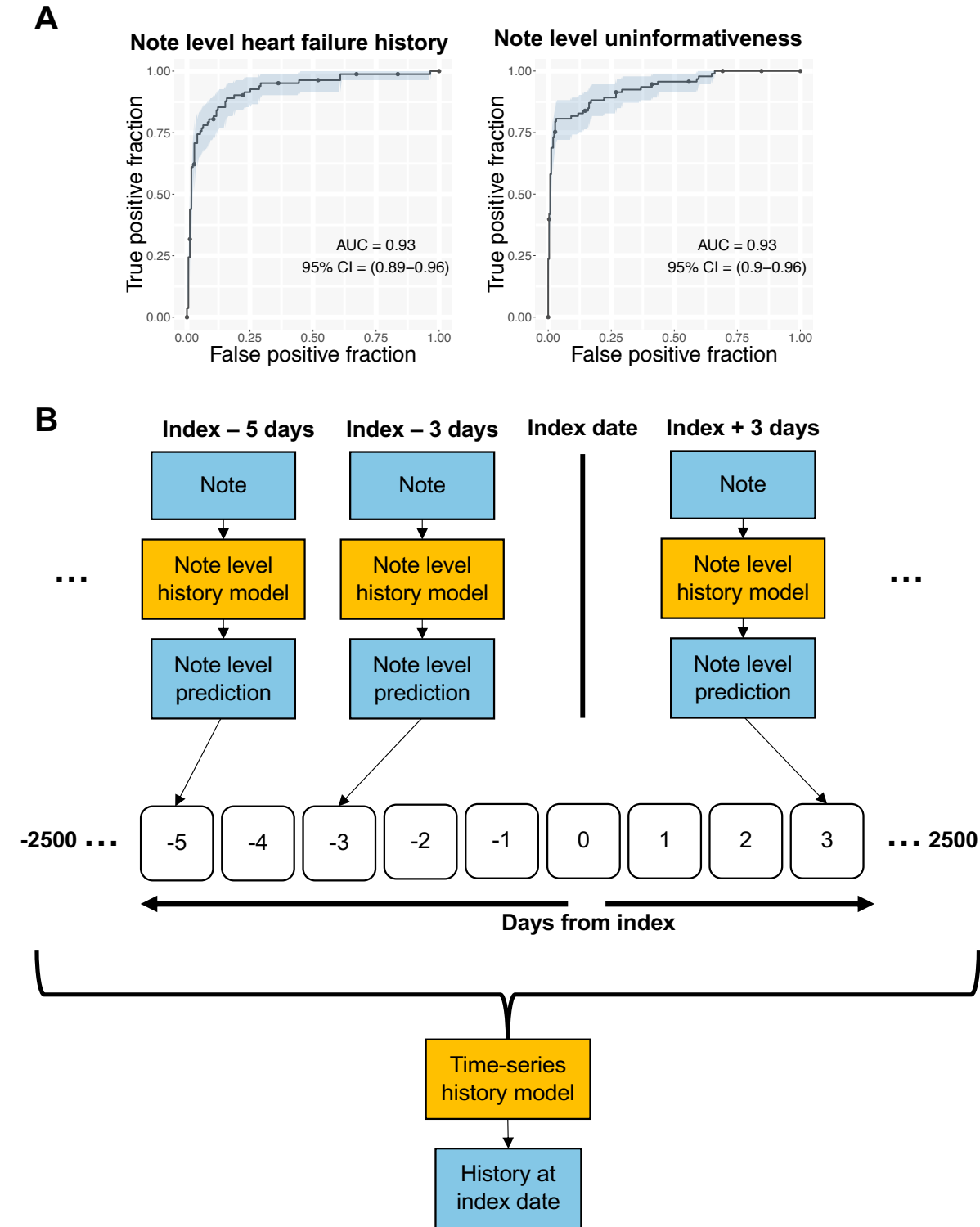

Figure S2: Past medical history model.

(A) ROC curves showing performance of note-level past medical history and uninformative-ness model. (B) Schematic drawing for time-series model for past medical history.

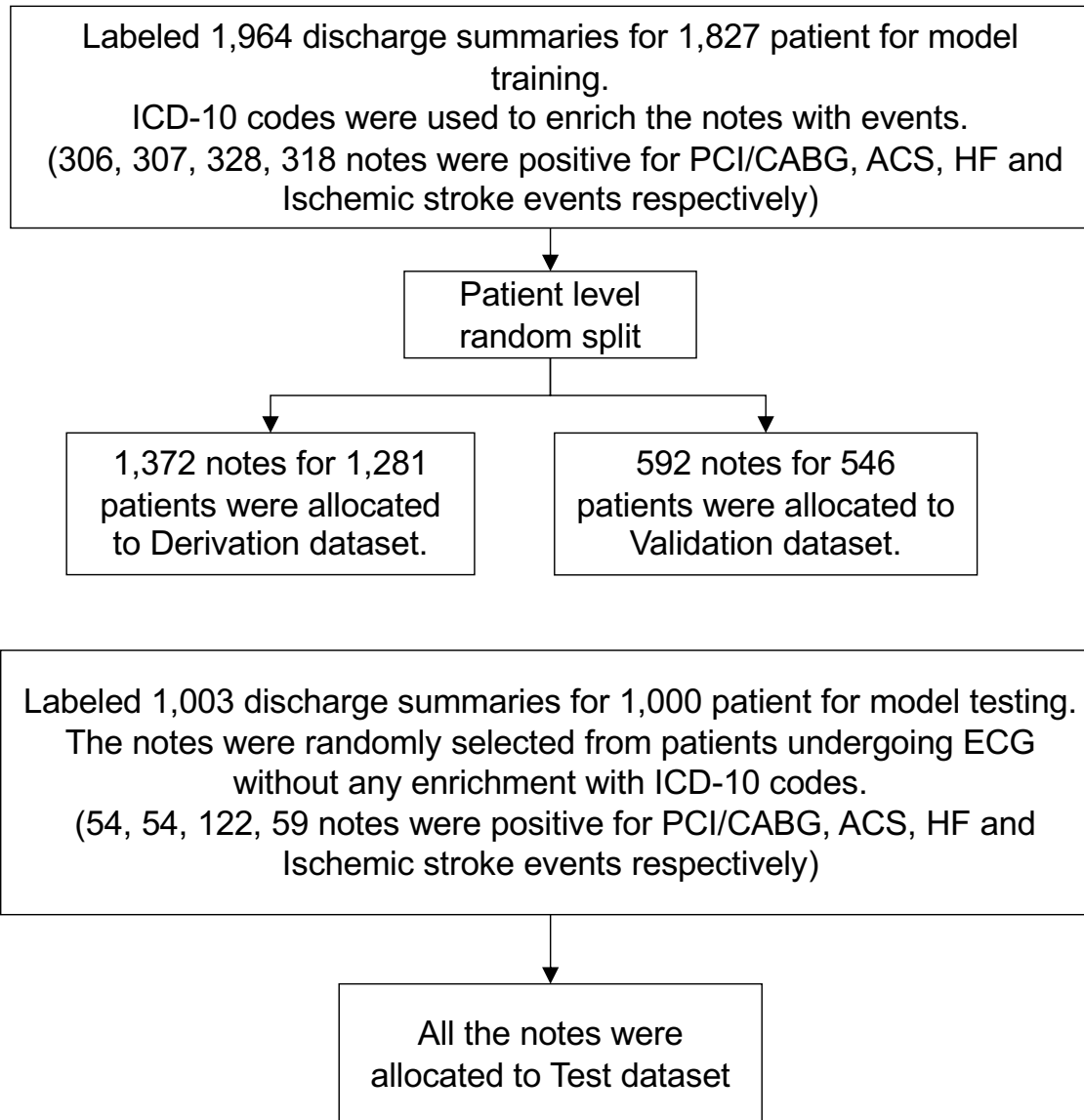

Figure S3. Flow diagram of notes selection used for training and testing event adjudication models.

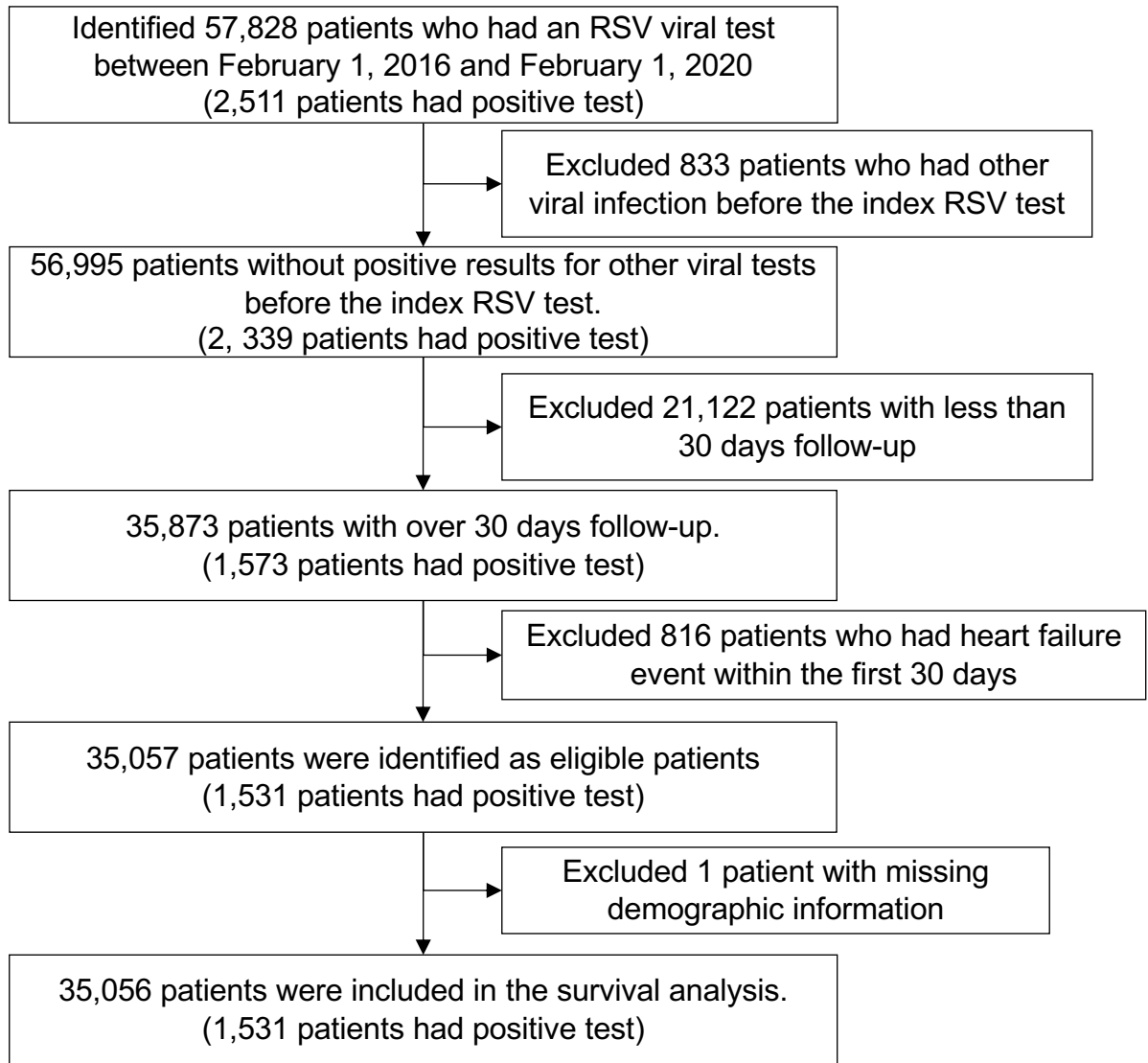

Figure S4. Flow diagram of patient selection for survival analysis for heart failure hospitalization in patients who had an RSV viral test between February 1, 2016 and February 1, 2020.

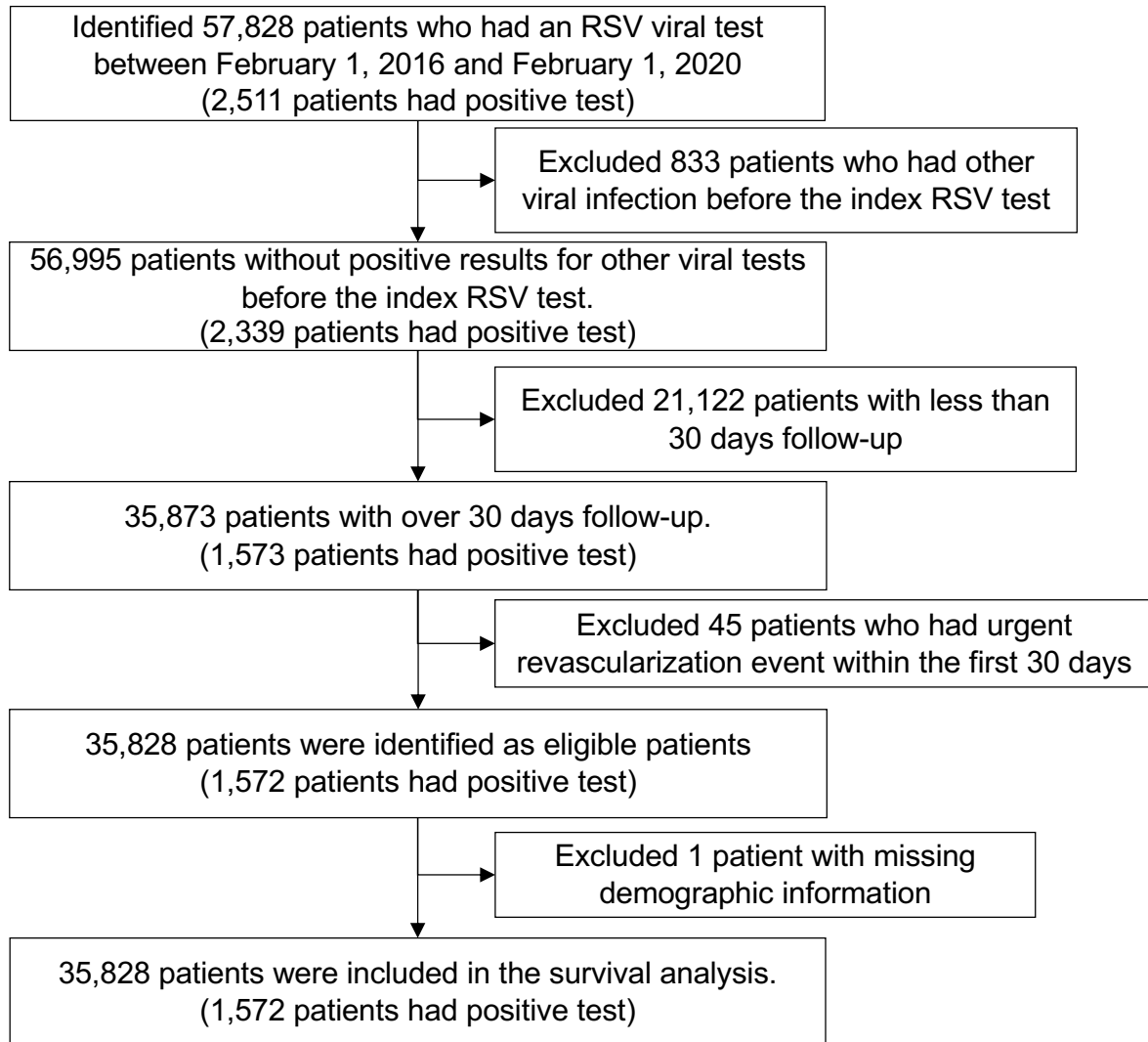

Figure S5. Flow diagram of patient selection for survival analysis on urgent revascularization in patients undergoing RSV viral tests.

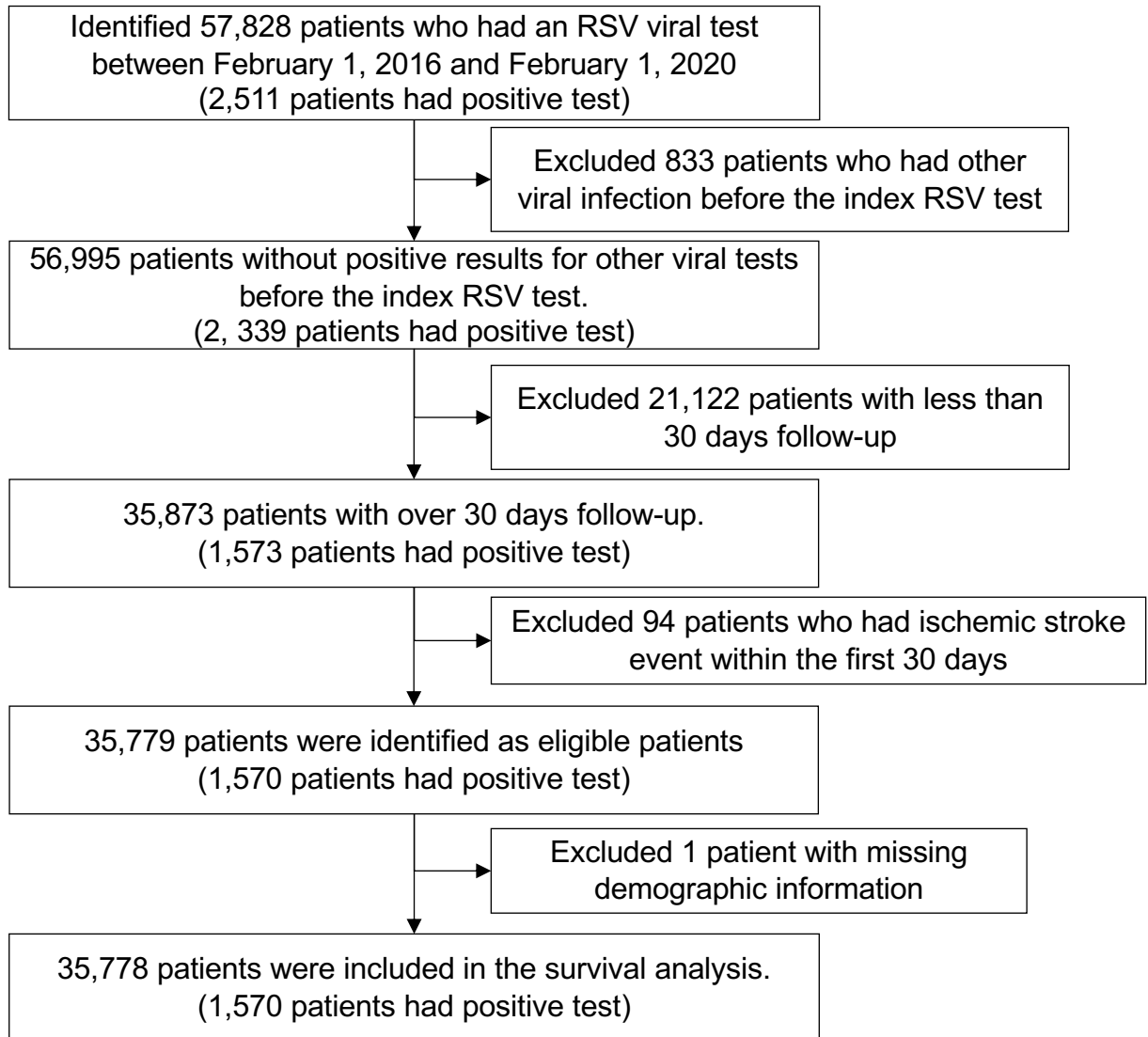

Figure S6. Flow diagram of patient selection for survival analysis on ischemic stroke in patients undergoing RSV viral tests.

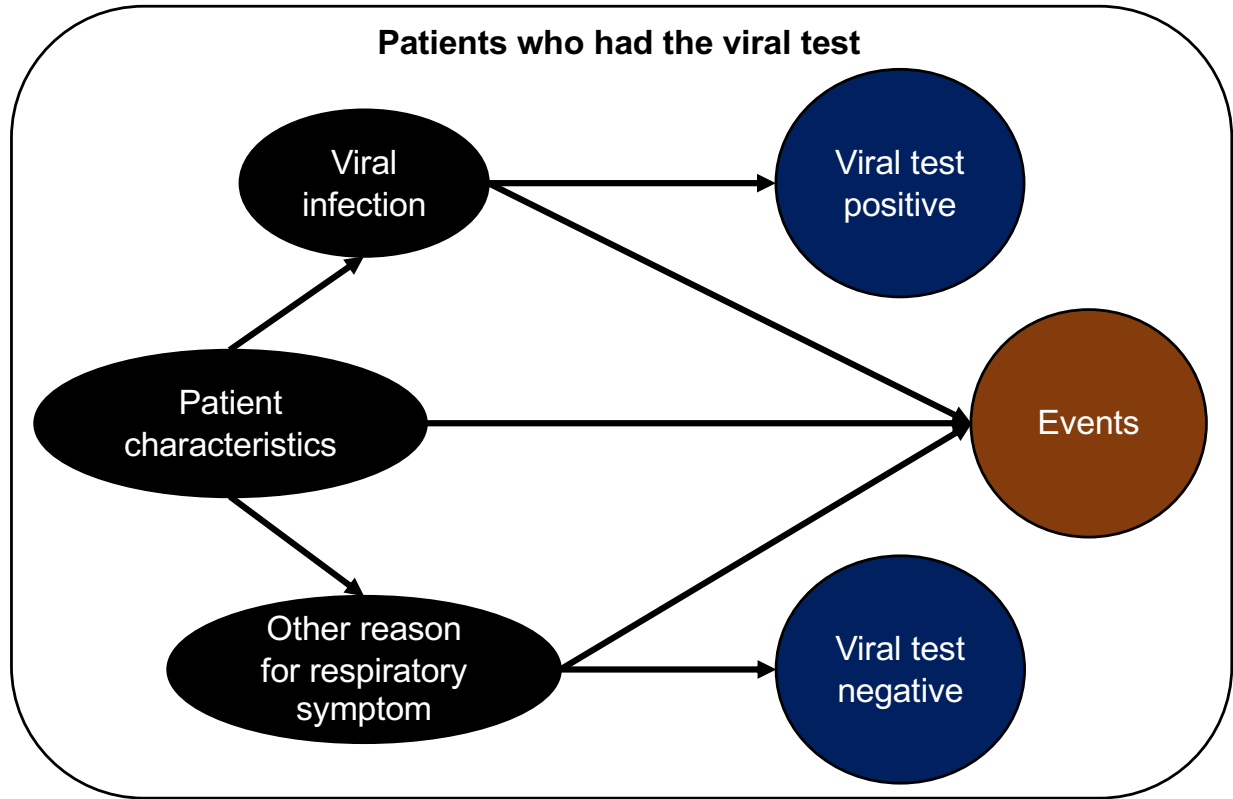

Figure S7. Graphical model illustrating potential selection bias in patients who underwent testing for a respiratory virus. Selecting patients based on having undergone a viral test induces an inverse association between viral infection and other causes of respiratory symptoms (collider bias). The latter may also influence the probability of delayed cardiovascular events, and thus were handled by adjustment.

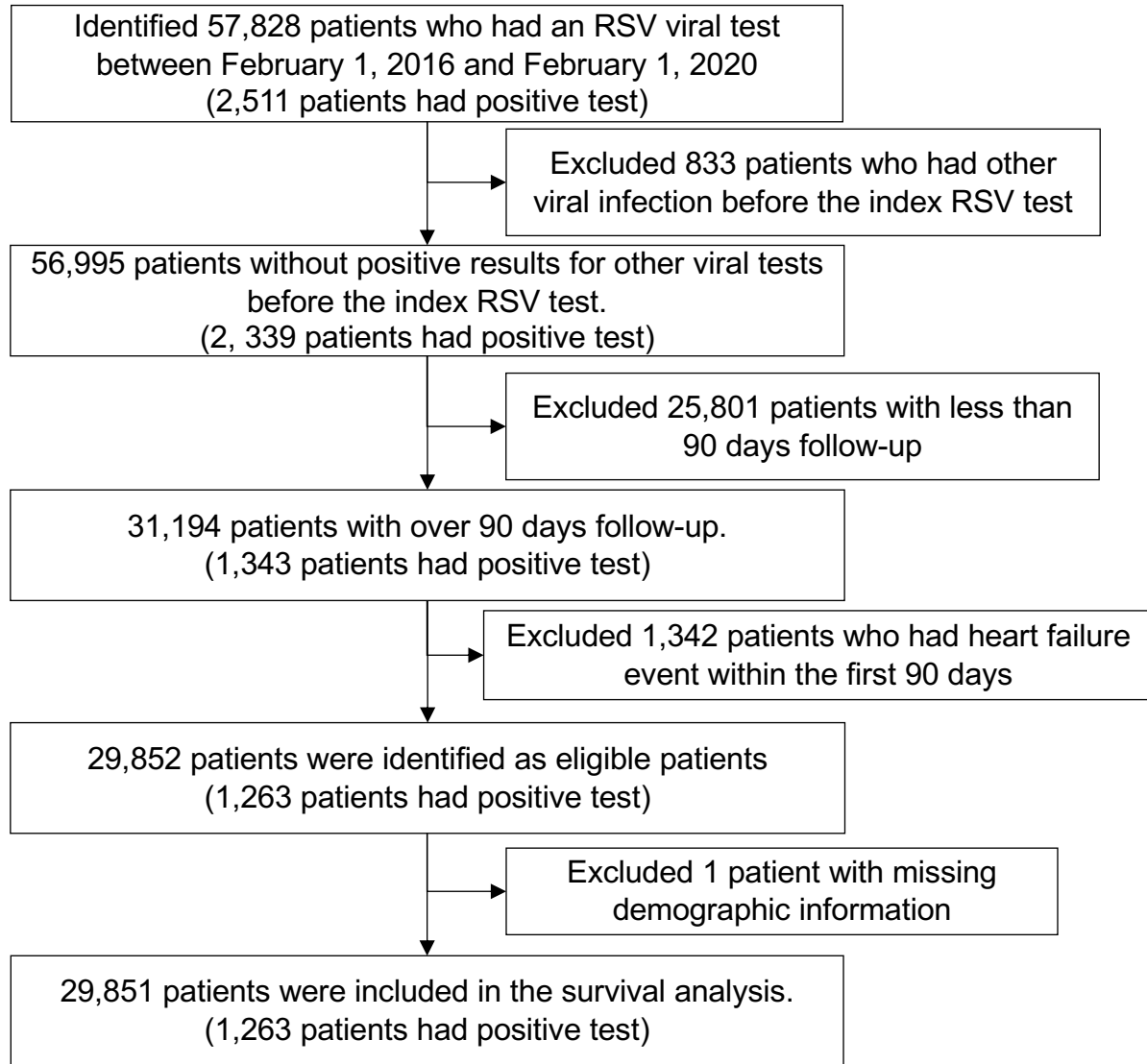

Figure S8. Flow diagram of patient selection for survival analysis on heart failure in patients undergoing RSV viral tests (excluding those who had event within the first 90 days).

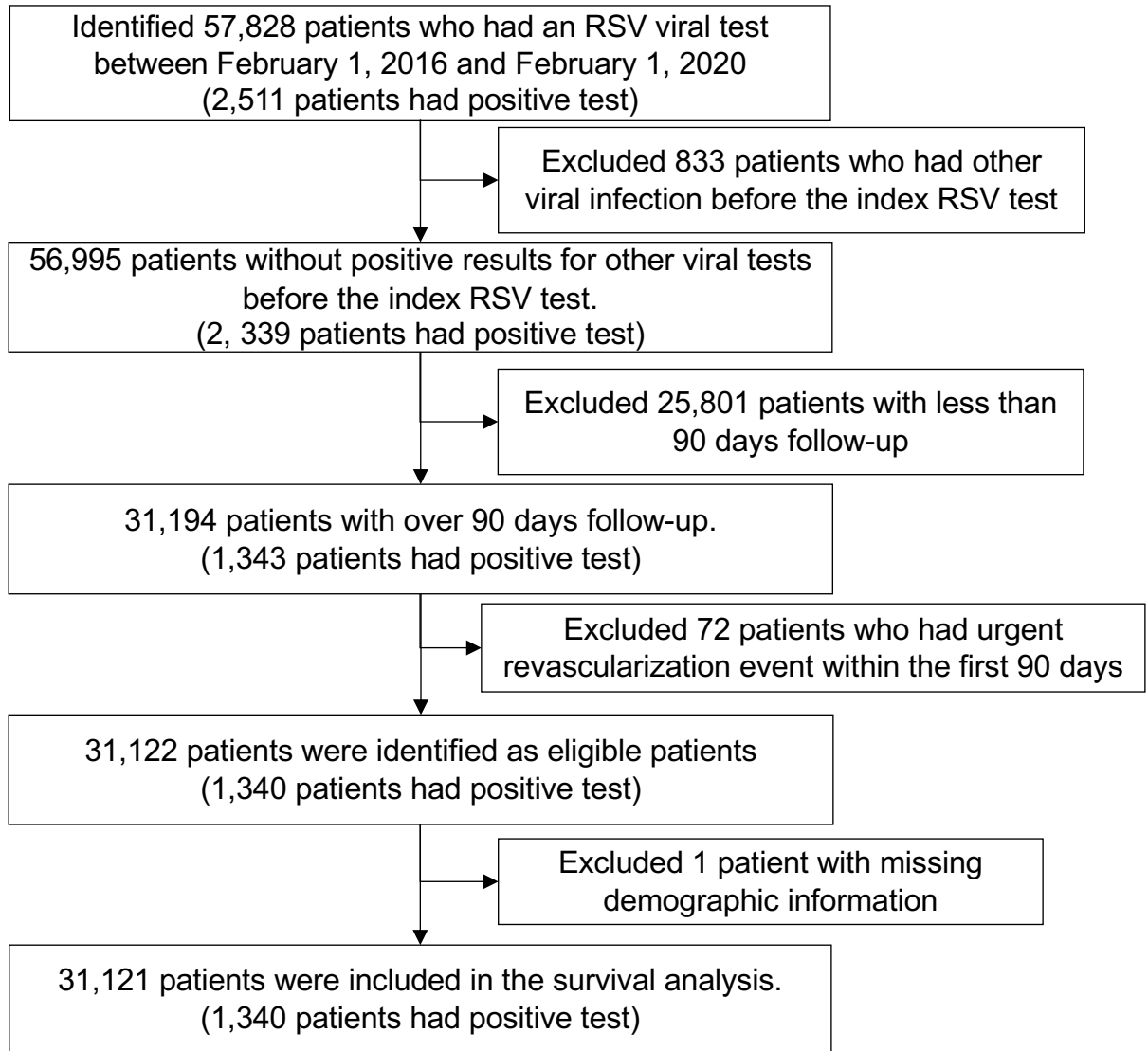

Figure S9. Flow diagram of patient selection for survival analysis on urgent revascularization in patients undergoing RSV viral tests (excluding those who had event within the first 90 days).

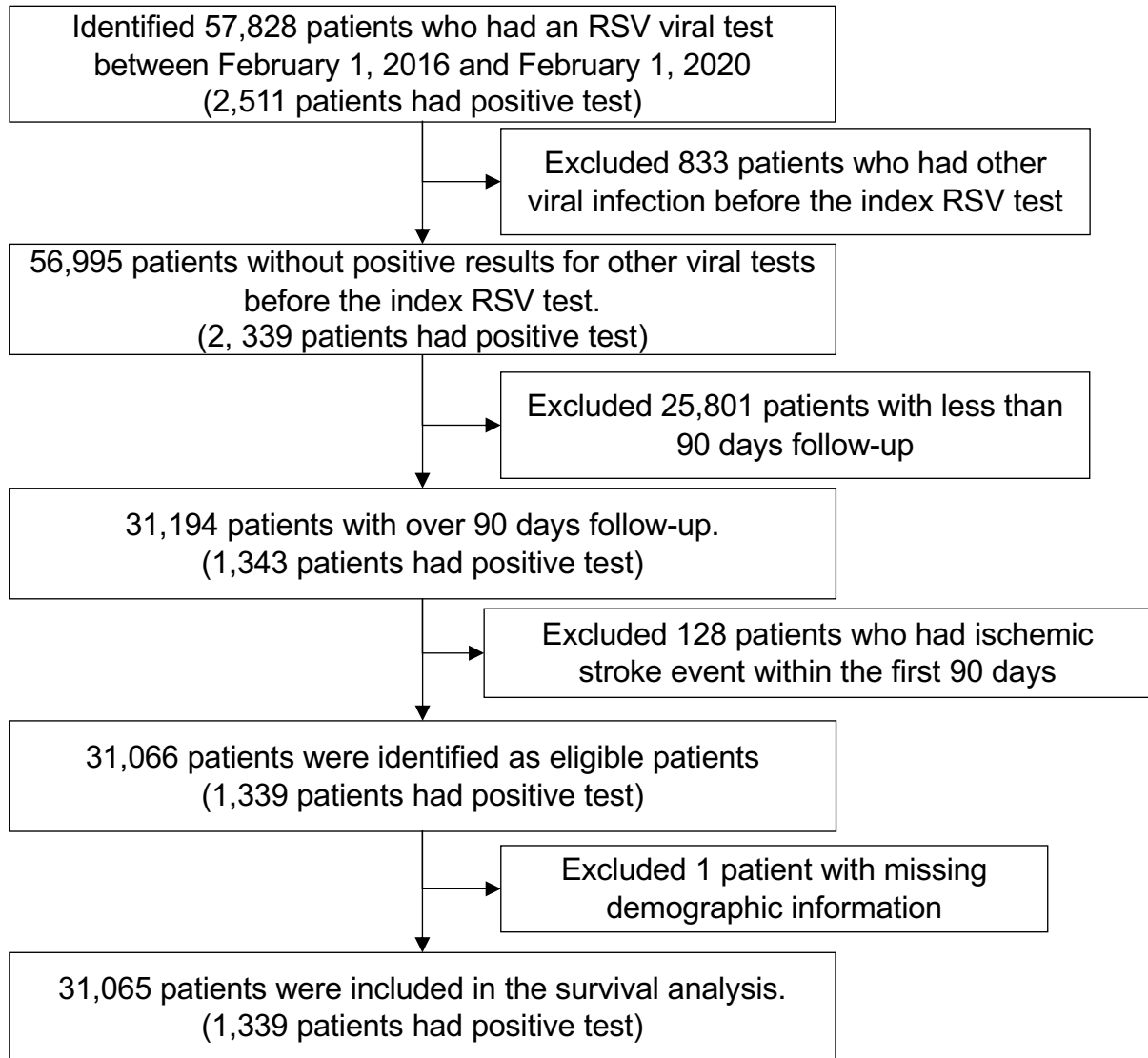

Figure S10. Flow diagram of patient selection for survival analysis on ischemic stroke in patients undergoing RSV viral tests (excluding those who had event within the first 90 days).

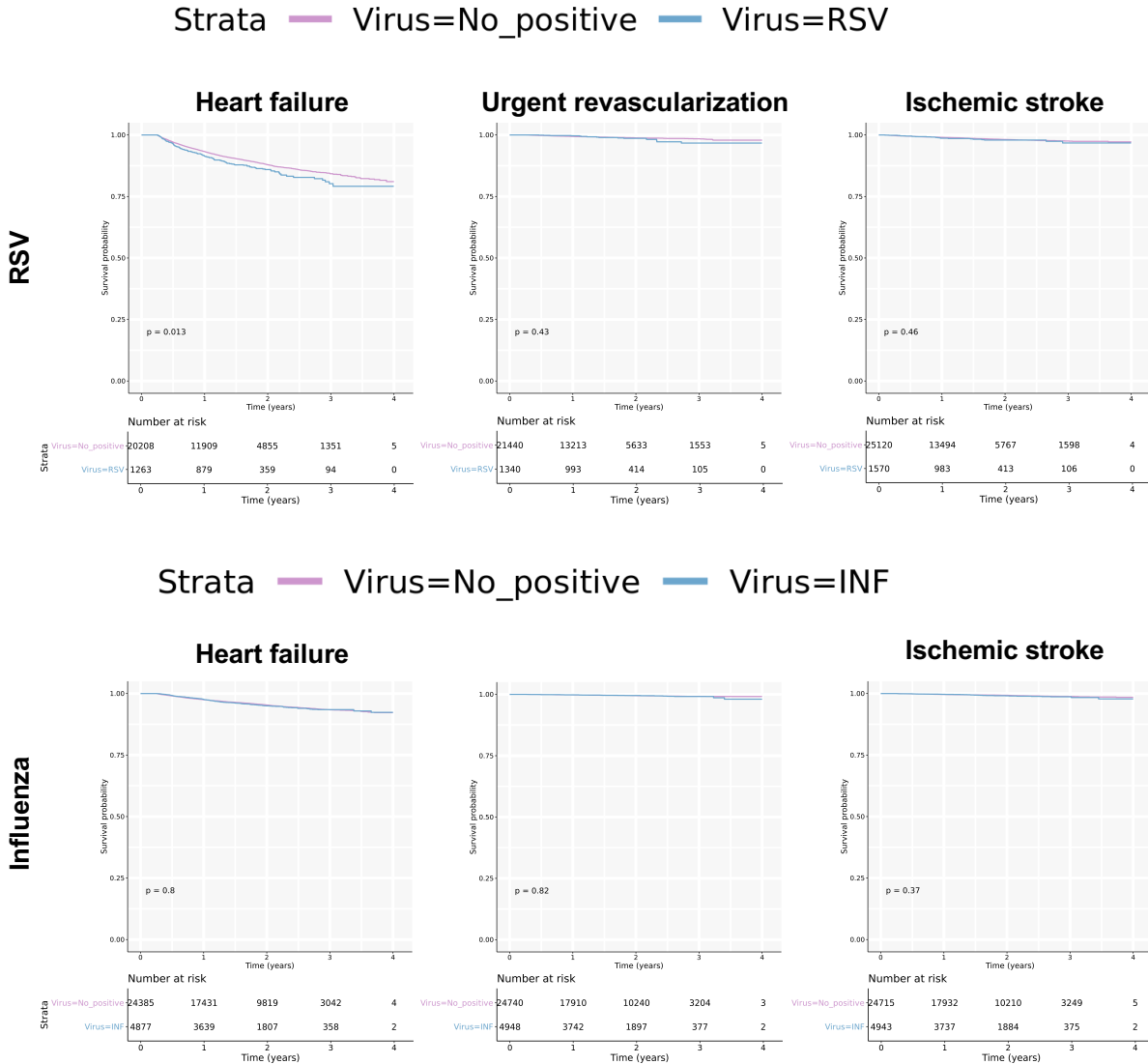

Figure S11. Survival analysis for RSV and influenza infection on cardiovascular events (excluding those who had event within the first 90 days).

Kaplan-Meier plot comparing event rates of heart failure hospitalization, urgent revascularization and ischemic stroke in virus positive and negative population for RSV and influenza. Abbreviations, RSV: respiratory syncytial virus, INF: influenza virus.

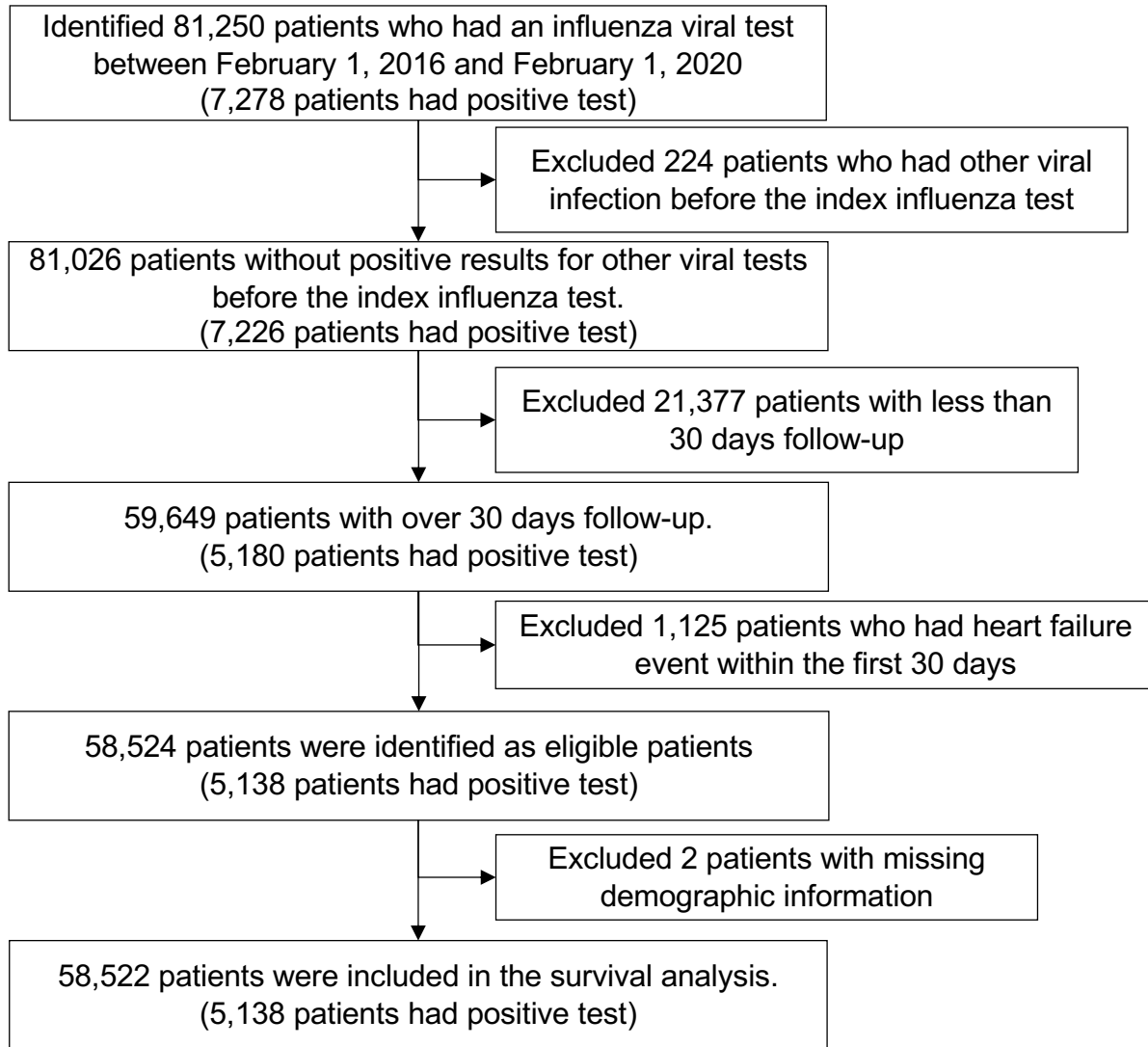

Figure S12. Flow diagram of patient selection for survival analysis on heart failure hospitalization in patients undergoing influenza viral tests.

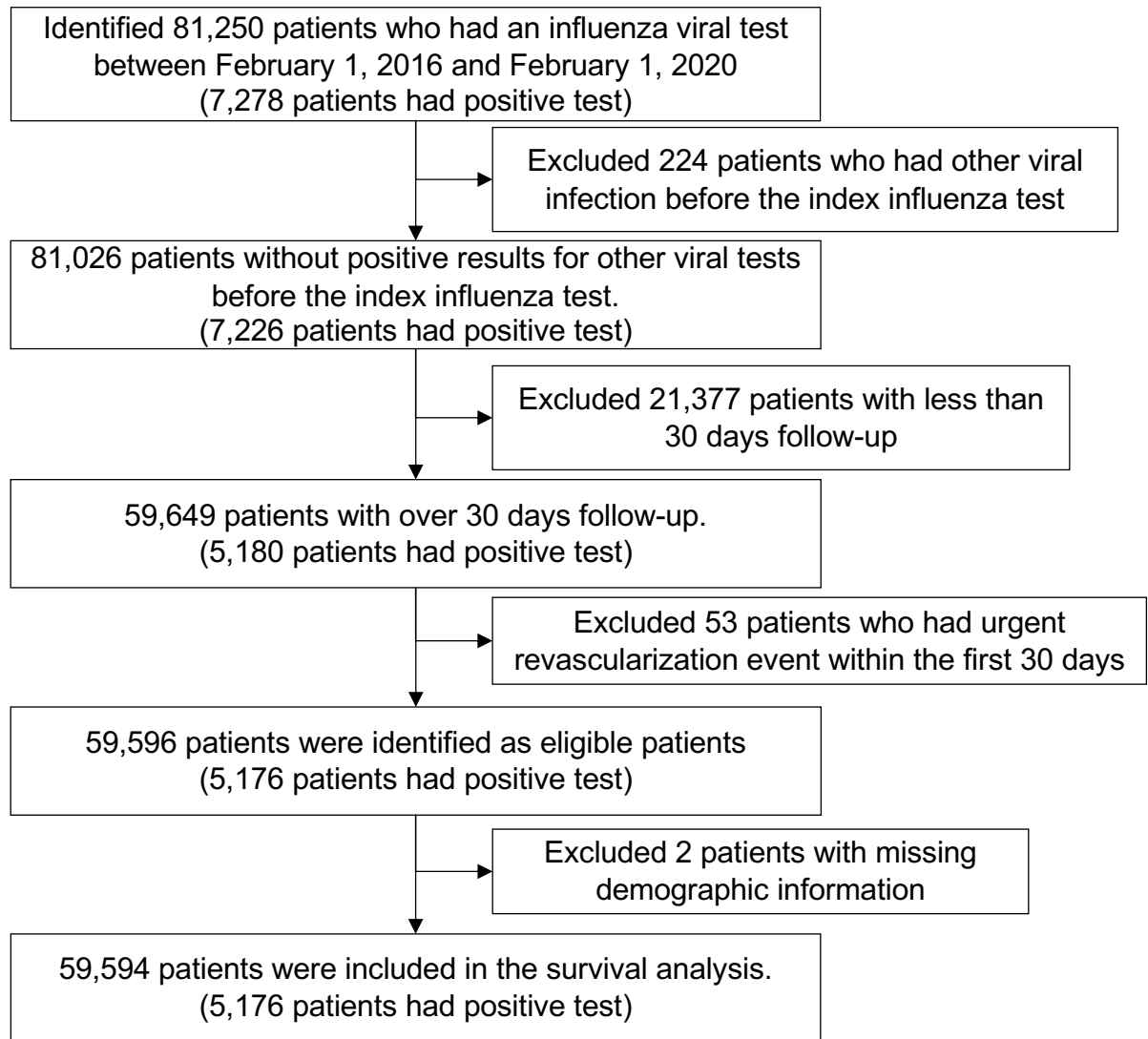

Figure S13. Flow diagram of patient selection for survival analysis on urgent revascularization in patients undergoing influenza viral tests.

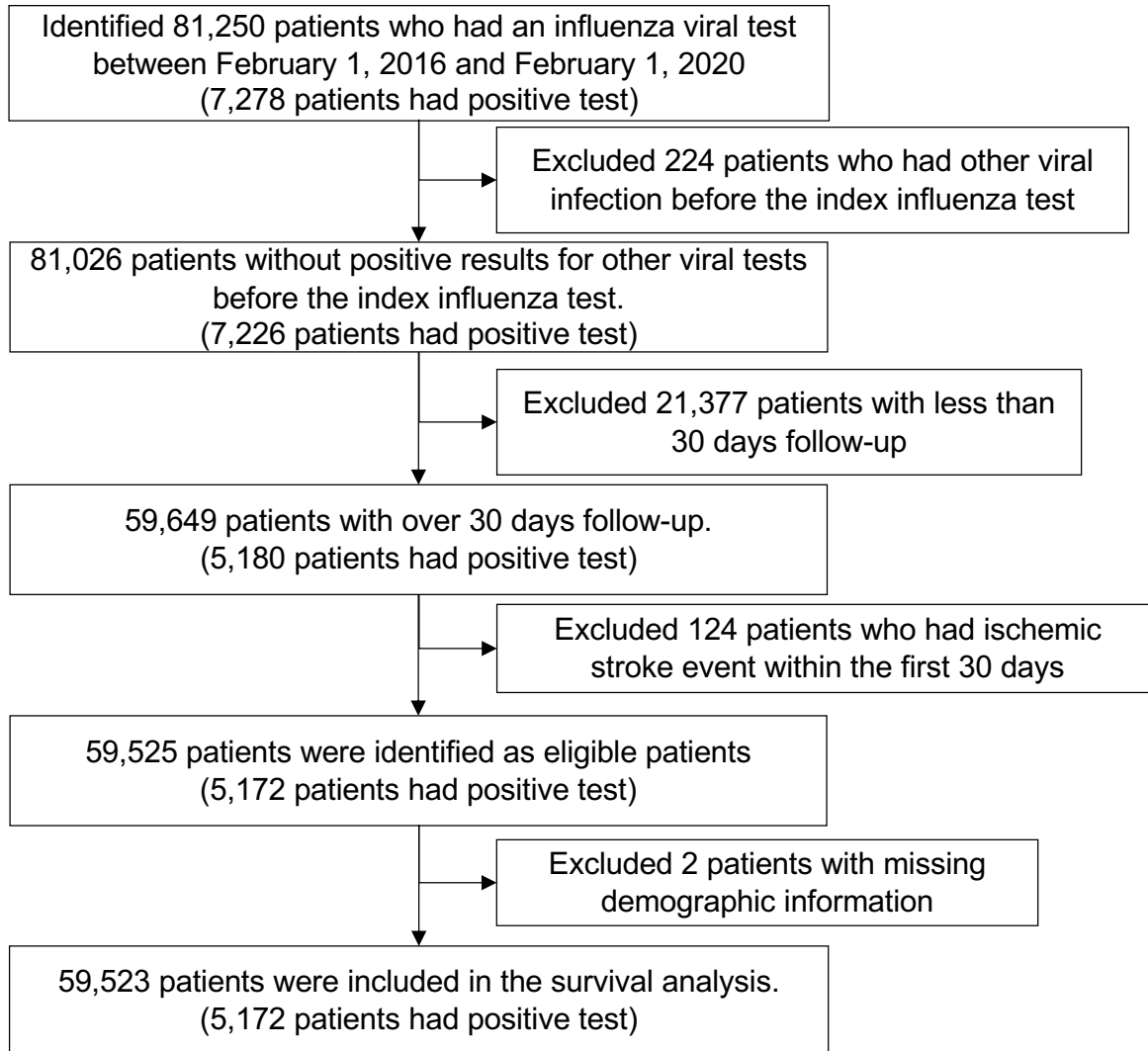

Figure S14. Flow diagram of patient selection for survival analysis on ischemic stroke in patients undergoing influenza viral tests.

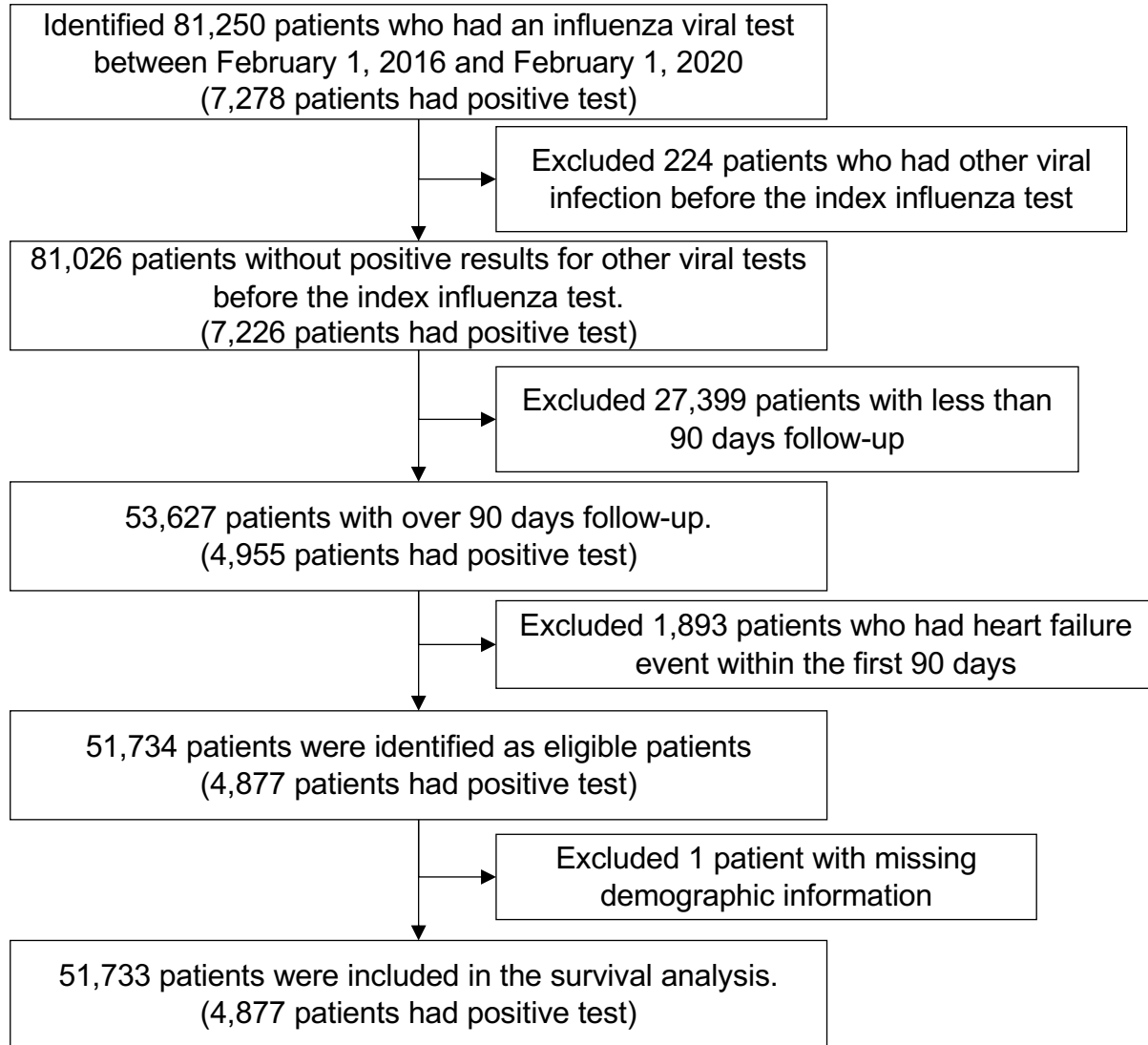

Figure S15. Flow diagram of patient selection for survival analysis on heart failure in patients undergoing influenza viral tests (excluding those who had event within the first 90 days).

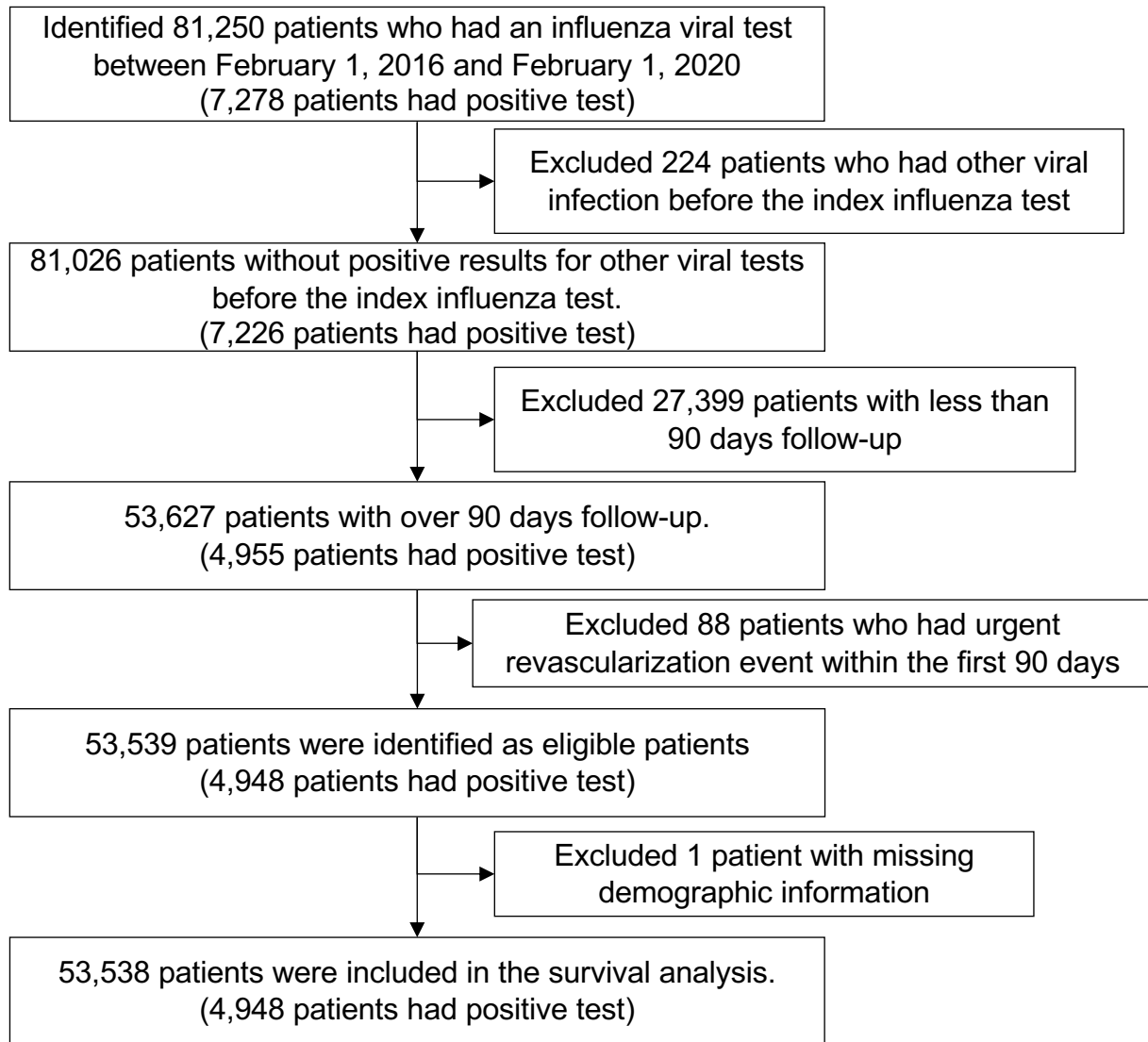

Figure S16. Flow diagram of patient selection for survival analysis on urgent revascularization in patients undergoing influenza viral tests (excluding those who had event within the first 90 days).

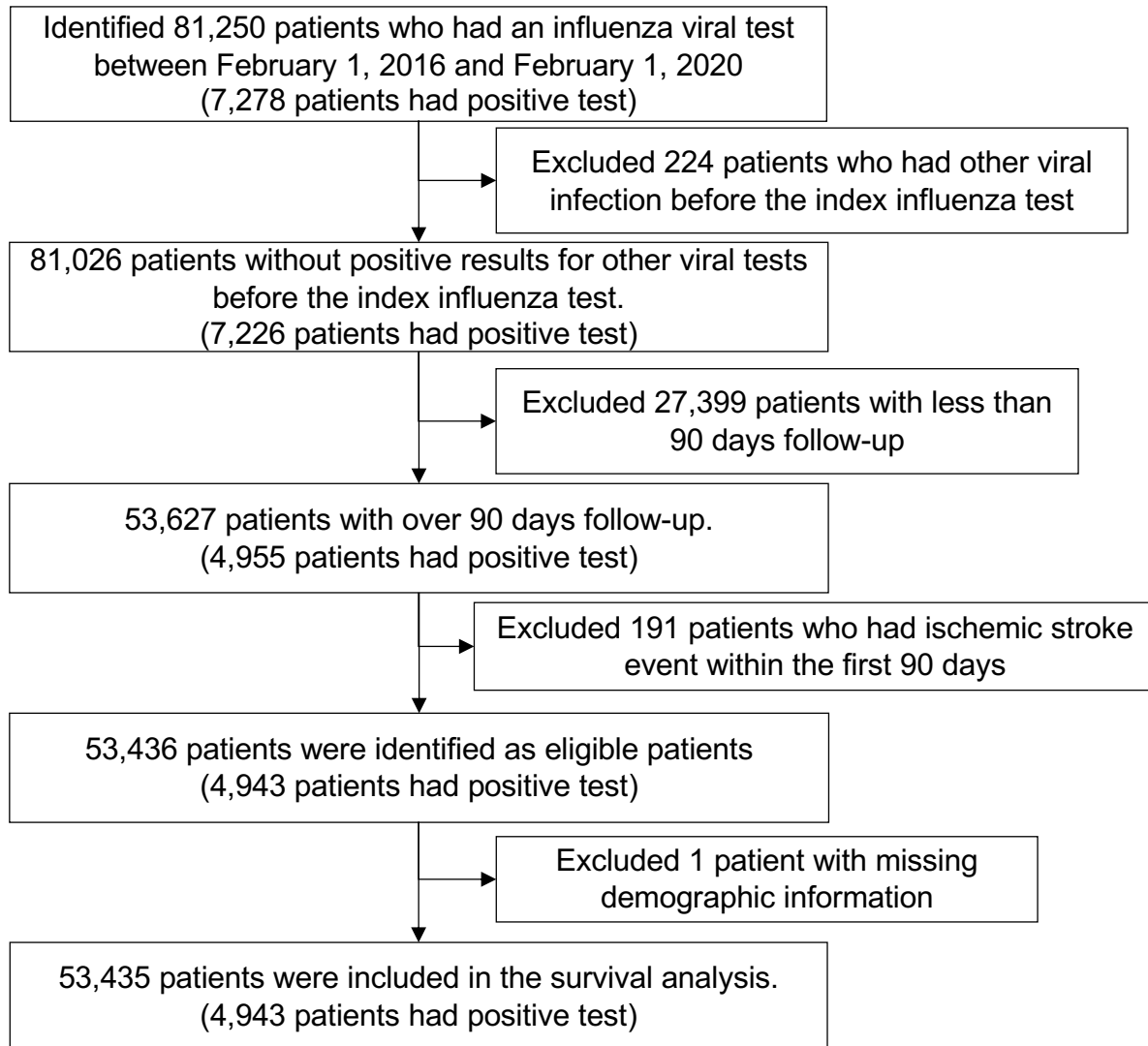

Figure S17. Flow diagram of patient selection for survival analysis on ischemic stroke in patients undergoing influenza viral tests (excluding those who had event within the first 90 days).

Supplementary Tables

Table S1. Demographics for the notes used for training and testing event models

	Training dataset	Test dataset
Numbers of notes	1964	1003
Events		
PCI/CABG, n (%)	306 (15.6)	54 (5.4)
ACS, n (%)	307 (15.6)	54 (5.4)
Heart failure hospitalization, n (%)	328 (16.7)	122 (16.7)
Ischemic stroke, n (%)	318 (16.2)	59 (5.9)
Institutions		
Brigham and Women's Hospital, n (%)	602 (30.7)	140 (14.0)
Brigham and Women's Faulkner Hospital, n (%)	121 (6.2)	110 (11.0)
Massachusetts General Hospital, n (%)	632 (32.2)	529 (52.7)
Cooley Dickinson Health Care, n (%)	43 (2.2)	0 (0.0)
Martha's Vineyard Hospital, n (%)	6 (0.3)	0 (0.0)
McLean Hospital, n (%)	2 (0.1)	0 (0.0)
Nantucket Cottage Hospital, n (%)	1 (0.1)	0 (0.0)
Massachusetts Eye and Ear, n (%)	1 (0.1)	0 (0.0)
Newton-Wellesley Hospital, n (%)	155 (7.9)	123 (12.3)
North Shore Medical Center, n (%)	173 (8.8)	101 (10.1)
South shore hospital, n (%)	5 (0.3)	0 (0.0)

Spaulding Hospital Cambridge, n (%)	4 (0.2)	0 (0.0)
Spaulding Hospital North Shore, n (%)	4 (0.2)	0 (0.0)
Spaulding Nursing and Therapy Center Brighton, n (%)	1 (0.1)	0 (0.0)
Spaulding Rehabilitation Hospital, n (%)	15 (0.8)	0 (0.0)
Union Hospital, n (%)	1 (0.1)	0 (0.0)
Wentworth-Douglass Hospital, n (%)	18 (0.9)	0 (0.0)
Unclear	180 (9.2)	0 (0.0)

Table S2. Demographics for the notes used for training and testing history model

	Training dataset	Test dataset
Numbers of notes	819	366
HF history label		
Yes, n (%)	181 (22.1)	82 (22.4)
No, n (%)	371 (45.3)	171 (46.7)
Ambiguous, n (%)	45 (5.5)	19 (5.2)
Uninformative, n (%)	222 (27.1)	94 (25.7)
Institutions		
Brigham and Women's Hospital, n (%)	422 (51.5)	189 (51.6)
Brigham and Women's Faulkner Hospital, n (%)	37 (4.5)	12 (3.3)
BWH Primary care Foxborough, n (%)	24 (2.9)	11 (3.0)
BWH Primary care Brookline, n (%)	4 (0.5)	3 (0.8)
BWH Primary care Norwood, n (%)	2 (0.2)	1 (0.3)
BWH Primary care Pembroke, n (%)	0 (0.0)	1 (0.3)
BWH at Newton Corner, n (%)	4 (0.5)	4 (1.1)
BWH Harbor Medical Associates, n (%)	4 (0.5)	3 (0.8)
Faulkner Community Physicians at Hyde Park, n (%)	3 (0.4)	0 (0.0)
Faulkner Community Physicians at West Roxbury, n (%)	3 (0.4)	4 (1.1)
Massachusetts General Hospital, n (%)	102 (12.5)	37 (10.1)
MGH West Medical Group, n (%)	0 (0.0)	1 (0.3)

MGH Danvers, n (%)	0 (0.0)	1 (0.3)
MGH Waltham, n (%)	1 (0.1)	1 (0.3)
MGH North Shore Center, n (%)	1 (0.1)	0 (0.0)
MGH Beacon Hill Primary Care, n (%)	0 (0.0)	1 (0.3)
MGH Downtown Primary Care, n (%)	1 (0.1)	0 (0.0)
MGB Urgent care, n (%)	0 (0.0)	2 (0.5)
Foxborough Health Care Center, n (%)	21 (2.6)	14 (3.8)
Dana-Farber Cancer Institute, n (%)	60 (7.3)	22 (6.0)
Essex Neurological Associates, n (%)	2 (0.2)	0 (0.0)
Lown Cardiovascular Group, n (%)	1 (0.1)	0 (0.0)
Cooley Dickinson Health Care, n (%)	1 (0.1)	1 (0.3)
Charles River Medical Associates, n (%)	12 (1.5)	8 (2.2)
Martha's Vineyard Hospital, n (%)	2 (0.2)	1 (0.3)
Milford Regional Physician Group, n (%)	1 (0.1)	1 (0.3)
Nantucket Cottage Hospital, n (%)	1 (0.1)	0 (0.0)
Massachusetts Eye and Ear, n (%)	9 (1.1)	5 (1.4)
Newton-Wellesley Hospital, n (%)	34 (4.2)	13 (3.6)
North End Waterfront Health, n (%)	2 (0.2)	0 (0.0)
North Shore Medical Center, n (%)	40 (4.9)	15 (4.1)
Ophthalmic Consultants of Boston, n (%)	2 (0.2)	0 (0.0)
Ophthalmic Consultants of Boston in Plymouth, n (%)	1 (0.1)	0 (0.0)

Ophthalmic Consultants of Boston in Yarmouth, n (%)	2 (0.2)	4 (1.1)
Peabody Podiatry, n (%)	0 (0.0)	2 (0.5)
Pentucket Medical Haverhill, n (%)	1 (0.1)	0 (0.0)
South shore hospital, n (%)	2 (0.2)	1 (0.3)
Spaulding Rehabilitation Hospital, n (%)	2 (0.2)	1 (0.3)
Spaulding Hospital Cambridge, n (%)	2 (0.2)	1 (0.3)
Spaulding Hospital Braintree, n (%)	1 (0.1)	0 (0.0)
Spaulding Hospital Framingham, n (%)	1 (0.1)	0 (0.0)
Spaulding Hospital Malden, n (%)	0 (0.0)	1 (0.3)
Spaulding Hospital Peabody, n (%)	0 (0.0)	3 (0.8)
Spaulding Hospital Salem, n (%)	1 (0.1)	0 (0.0)
Spaulding Hospital Wellesley, n (%)	1 (0.1)	0 (0.0)
Winchester Hospital, n (%)	2 (0.2)	0 (0.0)
Unclear	7 (0.9)	2 (0.5)

BWH: Brigham and Women's Hospital, MGH: Massachusetts General Hospital, MGB: Mass General Brigham.

Table S3. Baseline characteristics for survival analysis of heart failure hospitalization stratified by RSV infection (unmatched)

	RSV positive	RSV negative	SMD
Number patients	1531	33,525	
Demographics			
Age, years \pm SD	64.6 \pm 18.3	59.1 \pm 19.3	0.292
Gender, Male (%)	643 (42.0)	14,801 (44.1)	0.043
History of Smoking, Yes (%)	731 (47.7)	15,172 (45.3)	0.050
Race			0.085
White, n (%)	1,143 (74.7)	23,942 (71.4)	
Black, n (%)	156 (10.2)	3,686 (11.0)	
Hispanic, n (%)	43 (2.8)	1,087 (3.2)	
Asian, n (%)	49 (3.2)	1,249 (3.7)	
Others, n (%)	107 (7.0)	2,530 (7.5)	
Unknown, n (%)	33 (2.2)	1,031 (3.1)	
Disease history			
Heart failure, n (%)	355 (23.2)	5,337 (15.9)	0.184
CAD, n (%)	361 (23.6)	5,693 (17.0)	0.165
COPD, n (%)	413 (27.0)	6,257 (18.7)	0.196
Hyperlipidemia, n (%)	823 (53.8)	14,729 (43.9)	0.197
Hypertension, n (%)	1,014 (66.2)	18,533 (55.3)	0.226
Atrial fibrillation, n (%)	332 (21.7)	5,011 (14.9)	0.175

Type 2 DM, n (%)	444 (29.0)	7,809 (23.3)	0.130
Medication			
ASA, n (%)	626 (40.9)	11,879 (35.4)	0.112
P2Y ₁₂ Inhibitor, n (%)	74 (4.8)	1,510 (4.5)	0.016
Statin	718 (46.9)	13,133 (39.2)	0.156
ACEi, n (%)	300 (19.6)	6,689 (20.0)	0.009
ARB, n (%)	215 (14.0)	3,631 (10.8)	0.097
Beta blocker, n (%)	654 (42.7)	11,645 (34.7)	0.164
Loop diuretic, n (%)	445 (29.1)	6,601 (19.7)	0.220
MRA, n (%)	71 (4.6)	1,313 (3.9)	0.036
Virus testing method			
Method			0.023
A, n (%)	784 (51.2)	16,788 (50.1)	
B, n (%)	747 (48.8)	16,737 (49.9)	

Abbreviations. SMD: standardized mean difference, CAD: coronary heart disease, COPD: chronic obstructive pulmonary disease, DM: diabetes mellitus, ASA: acetyl-salicylic acid, ACEi: angiotensin-converting enzyme inhibitor, ARB: angiotensin II receptor blocker, MRA: mineralocorticoid receptor antagonist

Table S4. Baseline characteristics for survival analysis of urgent revascularization stratified by RSV infection (unmatched)

	RSV positive	RSV negative	SMD
Number patients	1572	34,255	
Demographics			
Age, years \pm SD	64.8 \pm 18.2	59.4 \pm 19.3	0.287
Gender, Male (%)	660 (42.0)	15,152 (44.2)	0.045
History of Smoking, Yes (%)	758 (48.2)	15,583 (45.5)	0.055
Race			0.081
White, n (%)	1,171 (74.5)	24,515 (71.6)	
Black, n (%)	163 (10.4)	3,761 (11.0)	
Hispanic, n (%)	43 (2.7)	1,103 (3.2)	
Asian, n (%)	49 (3.1)	1,268 (3.7)	
Others, n (%)	112 (7.1)	2,562 (7.5)	
Unknown, n (%)	34 (2.2)	1,046 (3.1)	
Disease history			
Heart failure, n (%)	386 (24.6)	5,834 (17.0)	0.186
CAD, n (%)	373 (23.7)	5,966 (17.4)	0.157
COPD, n (%)	430 (27.4)	6,522 (19.0)	0.198
Hyperlipidemia, n (%)	853 (54.3)	15,202 (44.4)	0.199
Hypertension, n (%)	1,050 (66.8)	19,144 (55.9)	0.225
Atrial fibrillation, n (%)	350 (22.3)	5,365 (15.7)	0.169

Type 2 DM, n (%)	461 (29.3)	8,087 (23.6)	0.130
Medication			
ASA, n (%)	652 (41.5)	12,275 (35.8)	0.116
P2Y ₁₂ Inhibitor, n (%)	76 (4.8)	1,576 (4.6)	0.011
Statin	748 (47.6)	13,574 (39.6)	0.161
ACEi, n (%)	313 (19.9)	6,900 (20.1)	0.006
ARB, n (%)	222 (14.1)	3,772 (11.0)	0.094
Beta blocker, n (%)	681 (43.3)	12,139 (35.4)	0.162
Loop diuretic, n (%)	475 (30.2)	7,090 (20.7)	0.220
MRA, n (%)	80 (5.1)	1,397 (4.1)	0.048
Virus testing method			
Method			0.026
A, n (%)	808 (51.4)	17,159 (50.1)	
B, n (%)	764 (48.6)	17,096 (49.9)	

Abbreviations. SMD: standardized mean difference, CAD: coronary heart disease, COPD: chronic obstructive pulmonary disease, DM: diabetes mellitus, ASA: acetyl-salicylic acid, ACEi: angiotensin-converting enzyme inhibitor, ARB: angiotensin II receptor blocker, MRA: mineralocorticoid receptor antagonist

Table S5. Baseline characteristics for survival analysis of stroke stratified by RSV infection (unmatched)

	RSV positive	RSV negative	SMD
Number patients	1570	34,208	
Demographics			
Age, years \pm SD	64.8 \pm 18.2	59.4 \pm 19.3	0.288
Gender, Male (%)	659 (42.0)	15,133 (44.2)	0.046
History of Smoking, Yes (%)	756 (48.2)	15,573 (45.5)	0.053
Race			0.079
White, n (%)	1,169 (74.5)	24,494 (71.6)	
Black, n (%)	163 (10.4)	3,747 (11.0)	
Hispanic, n (%)	43 (2.7)	1,103 (3.2)	
Asian, n (%)	49 (3.1)	1,262 (3.7)	
Others, n (%)	112 (7.1)	2,561 (7.5)	
Unknown, n (%)	34 (2.2)	1,041 (3.0)	
Disease history			
Heart failure, n (%)	386 (24.6)	5,824 (17.0)	0.187
CAD, n (%)	374 (23.8)	5,977 (17.5)	0.157
COPD, n (%)	428 (27.3)	6,511 (19.0)	0.196
Hyperlipidemia, n (%)	854 (54.4)	15,179 (44.4)	0.201
Hypertension, n (%)	1,047 (66.7)	19,108 (55.9)	0.224
Atrial fibrillation, n (%)	351 (22.4)	5,342 (15.6)	0.173

Type 2 DM, n (%)	460 (29.3)	8,069 (23.6)	0.130
Medication			
ASA, n (%)	653 (41.6)	12,256 (35.8)	0.119
P2Y ₁₂ Inhibitor, n (%)	76 (4.8)	1,571 (4.6)	0.012
Statin	749 (47.7)	13,548 (39.6)	0.164
ACEi, n (%)	311 (19.8)	6,882 (20.1)	0.008
ARB, n (%)	222 (14.1)	3,770 (11.0)	0.094
Beta blocker, n (%)	681 (43.4)	12,115 (35.4)	0.163
Loop diuretic, n (%)	474 (30.2)	7,084 (20.7)	0.219
MRA, n (%)	80 (5.1)	1,399 (4.1)	0.048
Virus testing method			
Method			0.027
A, n (%)	808 (51.5)	17,135 (50.1)	
B, n (%)	762 (48.5)	17,073 (49.9)	

Abbreviations. SMD: standardized mean difference, CAD: coronary heart disease, COPD: chronic obstructive pulmonary disease, DM: diabetes mellitus, ASA: acetyl-salicylic acid, ACEi: angiotensin-converting enzyme inhibitor, ARB: angiotensin II receptor blocker, MRA: mineralocorticoid receptor antagonist

Table S6. Baseline characteristics for survival analysis of heart failure hospitalization stratified by RSV infection (matched)

	RSV positive	RSV negative	SMD
Number patients	1531	24,496	
Demographics			
Age, years \pm SD	64.6 \pm 18.3	64.2 \pm 17.7	0.023
Gender, Male (%)	643 (42.0)	10,445 (42.6)	0.013
History of Smoking, Yes (%)	731 (47.7)	11,524 (47.0)	0.014
Race			0.019
White, n (%)	1,143 (74.7)	18,153 (74.1)	
Black, n (%)	156 (10.2)	2,571 (10.5)	
Hispanic, n (%)	43 (2.8)	716 (2.9)	
Asian, n (%)	49 (3.2)	795 (3.2)	
Others, n (%)	107 (7.0)	1,769 (7.2)	
Unknown, n (%)	33 (2.2)	492 (2.0)	
Disease history			
Heart failure, n (%)	355 (23.2)	5,030 (20.5)	0.064
CAD, n (%)	361 (23.6)	5,315 (21.7)	0.045
COPD, n (%)	413 (27.0)	5,947 (24.3)	0.062
Hyperlipidemia, n (%)	823 (53.8)	12,933 (52.8)	0.019
Hypertension, n (%)	1,014 (66.2)	16,043 (65.5)	0.016
Atrial fibrillation, n (%)	332 (21.7)	4,746 (19.4)	0.057

Type 2 DM, n (%)	444 (29.0)	6,910 (28.2)	0.018
Medication			
ASA, n (%)	626 (40.9)	9,979 (40.7)	0.003
P2Y ₁₂ Inhibitor, n (%)	74 (4.8)	1,224 (5.0)	0.008
Statin	718 (46.9)	11,501 (47.0)	0.001
ACEi, n (%)	300 (19.6)	5,686 (23.2)	0.088
ARB, n (%)	215 (14.0)	3,240 (13.2)	0.024
Beta blocker, n (%)	654 (42.7)	10,108 (41.3)	0.029
Loop diuretic, n (%)	445 (29.1)	6,282 (25.6)	0.077
MRA, n (%)	71 (4.6)	1,168 (4.8)	0.006
Virus testing method			
Method			<0.001
A, n (%)	784 (51.2)	12,539 (51.2)	
B, n (%)	747 (48.8)	11,957 (48.8)	

Abbreviations. SMD: standardized mean difference, CAD: coronary heart disease, COPD: chronic obstructive pulmonary disease, DM: diabetes mellitus, ASA: acetyl-salicylic acid, ACEi: angiotensin-converting enzyme inhibitor, ARB: angiotensin II receptor blocker, MRA: mineralocorticoid receptor antagonist

Table S7. Baseline characteristics for survival analysis of urgent revascularization stratified by RSV infection (matched)

	RSV positive	RSV negative	SMD
Number patients	1572	25,152	
Demographics			
Age, years \pm SD	64.8 \pm 18.2	64.4 \pm 17.7	0.022
Gender, Male (%)	660 (42.0)	10,670 (42.4)	0.009
History of Smoking, Yes (%)	758 (48.2)	12,039 (47.9)	0.007
Race			0.011
White, n (%)	1,171 (74.5)	18,654 (74.2)	
Black, n (%)	163 (10.4)	2,666 (10.6)	
Hispanic, n (%)	43 (2.7)	673 (2.7)	
Asian, n (%)	49 (3.1)	793 (3.2)	
Others, n (%)	112 (7.1)	1,830 (7.3)	
Unknown, n (%)	34 (2.2)	536 (2.1)	
Disease history			
Heart failure, n (%)	386 (24.6)	5,450 (21.7)	0.069
CAD, n (%)	373 (23.7)	5,524 (22.0)	0.042
COPD, n (%)	430 (27.4)	6,210 (24.7)	0.061
Hyperlipidemia, n (%)	853 (54.3)	13,399 (53.3)	0.020
Hypertension, n (%)	1,050 (66.8)	16,623 (66.1)	0.015
Atrial fibrillation, n (%)	350 (22.3)	5,060 (20.1)	0.053

Type 2 DM, n (%)	461 (29.3)	7,167 (28.5)	0.018
Medication			
ASA, n (%)	652 (41.5)	10,418 (41.4)	0.001
P2Y ₁₂ Inhibitor, n (%)	76 (4.8)	1,230 (4.9)	0.003
Statin	748 (47.6)	11,928 (47.4)	0.003
ACEi, n (%)	313 (19.9)	5,880 (23.4)	0.084
ARB, n (%)	222 (14.1)	3,354 (13.3)	0.023
Beta blocker, n (%)	681 (43.3)	10,558 (42.0)	0.027
Loop diuretic, n (%)	475 (30.2)	6,759 (26.9)	0.074
MRA, n (%)	80 (5.1)	1,233 (4.9)	0.009
Virus testing method			
Method			0.002
A, n (%)	808 (51.4)	12,901 (51.4)	
B, n (%)	764 (48.6)	12,251 (48.6)	

Abbreviations. SMD: standardized mean difference, CAD: coronary heart disease, COPD: chronic obstructive pulmonary disease, DM: diabetes mellitus, ASA: acetyl-salicylic acid, ACEi: angiotensin-converting enzyme inhibitor, ARB: angiotensin II receptor blocker, MRA: mineralocorticoid receptor antagonist

Table S8. Baseline characteristics for survival analysis of stroke stratified by RSV infection (matched)

	RSV positive	RSV negative	SMD
Number patients	1570	25,120	
Demographics			
Age, years \pm SD	64.8 \pm 18.2	64.3 \pm 17.8	0.025
Gender, Male (%)	659 (42.0)	10,638 (42.3)	0.008
History of Smoking, Yes (%)	756 (48.2)	12,014 (47.8)	0.007
Race			0.015
White, n (%)	1,169 (74.5)	18,621 (74.1)	
Black, n (%)	163 (10.4)	2,640 (10.5)	
Hispanic, n (%)	43 (2.7)	717 (2.9)	
Asian, n (%)	49 (3.1)	798 (3.2)	
Others, n (%)	112 (7.1)	1,836 (7.3)	
Unknown, n (%)	34 (2.2)	508 (2.0)	
Disease history			
Heart failure, n (%)	386 (24.6)	5,461 (21.7)	0.068
CAD, n (%)	374 (23.8)	5,576 (22.2)	0.039
COPD, n (%)	428 (27.3)	6,202 (24.7)	0.059
Hyperlipidemia, n (%)	854 (54.4)	13,429 (53.5)	0.019
Hypertension, n (%)	1,047 (66.7)	16,538 (65.8)	0.018
Atrial fibrillation, n (%)	351 (22.4)	5,053 (20.1)	0.055

Type 2 DM, n (%)	460 (29.3)	7,161 (28.5)	0.017
Medication			
ASA, n (%)	653 (41.6)	10,413 (41.5)	0.003
P2Y ₁₂ Inhibitor, n (%)	76 (4.8)	1,279 (5.1)	0.012
Statin	749 (47.7)	11,973 (47.7)	0.001
ACEi, n (%)	311 (19.8)	5,855 (23.3)	0.085
ARB, n (%)	222 (14.1)	3,365 (13.4)	0.022
Beta blocker, n (%)	681 (43.4)	12,146 (48.4)	0.022
Loop diuretic, n (%)	474 (30.2)	6,740 (26.8)	0.074
MRA, n (%)	80 (5.1)	1,233 (4.9)	0.009
Virus testing method			
Method			0.004
A, n (%)	808 (51.5)	12,974 (51.9)	
B, n (%)	762 (48.5)	12,146 (48.4)	

Abbreviations. SMD: standardized mean difference, CAD: coronary heart disease, COPD: chronic obstructive pulmonary disease, DM: diabetes mellitus, ASA: acetyl-salicylic acid, ACEi: angiotensin-converting enzyme inhibitor, ARB: angiotensin II receptor blocker, MRA: mineralocorticoid receptor antagonist

Table S9. Baseline characteristics for survival analysis of heart failure stratified by RSV infection (with 90 days exclusion window, unmatched)

	RSV positive	RSV negative	SMD
Number patients	1,263	28,588	
Demographics			
Age, years \pm SD	64.1 \pm 18.3	58.6 \pm 19.2	0.294
Gender, Male (%)	537 (42.5)	12,405 (43.4)	0.018
History of Smoking, Yes (%)	599 (47.4)	12,770 (44.7)	0.055
Race			0.117
White, n (%)	953 (75.5)	20,254 (70.8)	
Black, n (%)	123 (9.7)	3,227 (11.3)	
Hispanic, n (%)	32 (2.5)	991 (3.5)	
Asian, n (%)	43 (3.4)	1,069 (3.7)	
Others, n (%)	87 (6.9)	2,178 (7.6)	
Unknown, n (%)	25 (2.0)	869 (3.0)	
Disease history			
Heart failure, n (%)	272 (21.5)	4,329 (15.1)	0.166
CAD, n (%)	271 (21.5)	4,805 (16.8)	0.118
COPD, n (%)	347 (27.5)	5,380 (18.8)	0.206
Hyperlipidemia, n (%)	671 (53.1)	12,720 (44.5)	0.173

Hypertension, n (%)	837 (66.3)	15,909 (55.6)	0.219
Atrial fibrillation, n (%)	257 (14.5)	4,155 (14.5)	0.154
Type 2 DM, n (%)	351 (23.3)	6,651 (23.3)	0.104
Medication			
ASA, n (%)	500 (39.6)	10,079 (35.3)	0.090
P2Y ₁₂ Inhibitor, n (%)	58 (4.6)	1,230 (4.3)	0.014
Statin	589 (46.6)	11,043 (38.6)	0.162
ACEi, n (%)	248 (19.6)	5,715 (20.0)	0.009
ARB, n (%)	176 (13.9)	3,106 (10.9)	0.093
Beta blocker, n (%)	525 (41.6)	9,701 (33.9)	0.158
Loop diuretic, n (%)	336 (26.6)	5,204 (18.2)	0.202
MRA, n (%)	54 (4.3)	1,033 (3.6)	0.034
Virus testing method			
Method			0.025
A, n (%)	652 (51.6)	14,403 (50.4)	
B, n (%)	611 (48.4)	14,185 (49.6)	

Abbreviations. SMD: standardized mean difference, CAD: coronary heart disease, COPD: chronic obstructive pulmonary disease, DM: diabetes mellitus, ASA: acetyl-salicylic acid, ACEi: angiotensin-converting enzyme inhibitor, ARB: angiotensin II receptor blocker, MRA: mineralocorticoid receptor antagonist

Table S10. Baseline characteristics for survival analysis of urgent revascularization stratified by RSV infection (with 90 days exclusion window, unmatched)

	RSV positive	RSV negative	SMD
Number patients	1,340	29,781	
Demographics			
Age, years \pm SD	64.6 \pm 18.2	59.1 \pm 19.2	0.295
Gender, Male (%)	568 (42.4)	13,001 (43.7)	0.026
History of Smoking, Yes (%)	645 (48.1)	13,438 (45.1)	0.060
Race			0.103
White, n (%)	1,008 (75.2)	21,188 (71.1)	
Black, n (%)	134 (10.0)	3,356 (11.3)	
Hispanic, n (%)	33 (2.5)	1,017 (3.4)	
Asian, n (%)	43 (3.2)	1,097 (3.7)	
Others, n (%)	93 (6.9)	2,228 (7.5)	
Unknown, n (%)	29 (2.2)	895 (3.0)	
Disease history			
Heart failure, n (%)	342 (25.5)	5,230 (17.6)	0.195
CAD, n (%)	311 (23.2)	5,283 (17.7)	0.136
COPD, n (%)	381 (28.4)	5,819 (19.5)	0.209
Hyperlipidemia, n (%)	732 (54.6)	13,531 (45.4)	0.185
Hypertension, n (%)	909 (67.8)	16,947 (56.9)	0.227

Atrial fibrillation, n (%)	298 (22.2)	4,739 (15.9)	0.162
Type 2 DM, n (%)	391 (23.3)	7,178 (24.1)	0.115
Medication			
ASA, n (%)	548 (40.9)	10,748 (36.1)	0.099
P2Y ₁₂ Inhibitor, n (%)	61 (4.6)	1,347 (4.5)	0.001
Statin	647 (48.3)	11,815 (39.7)	0.174
ACEi, n (%)	271 (20.2)	6,075 (20.4)	0.004
ARB, n (%)	193 (14.4)	3,320 (11.1)	0.098
Beta blocker, n (%)	583 (43.5)	10,529 (35.4)	0.167
Loop diuretic, n (%)	403 (30.1)	6,055 (20.3)	0.226
MRA, n (%)	69 (5.1)	1,199 (4.0)	0.054
Virus testing method			
Method			0.026
A, n (%)	693 (51.7)	15,020 (50.4)	
B, n (%)	647 (48.3)	14,761 (49.6)	

Abbreviations. SMD: standardized mean difference, CAD: coronary heart disease, COPD: chronic obstructive pulmonary disease, DM: diabetes mellitus, ASA: acetyl-salicylic acid, ACEi: angiotensin-converting enzyme inhibitor, ARB: angiotensin II receptor blocker, MRA: mineralocorticoid receptor antagonist

Table S11. Baseline characteristics for survival analysis of ischemic stroke stratified by RSV infection (with 90 days exclusion window, unmatched)

	RSV positive	RSV negative	SMD
Number patients	1,339	29,726	
Demographics			
Age, years \pm SD	64.6 \pm 18.2	59.1 \pm 19.2	0.297
Gender, Male (%)	569 (42.5)	12,981 (43.7)	0.024
History of Smoking, Yes (%)	644 (48.1)	13,426 (45.2)	0.059
Race			0.101
White, n (%)	1,006 (75.1)	21,169 (71.2)	
Black, n (%)	135 (10.1)	3,333 (11.2)	
Hispanic, n (%)	33 (2.5)	1,017 (3.4)	
Asian, n (%)	43 (3.2)	1,090 (3.7)	
Others, n (%)	93 (6.9)	2,224 (7.5)	
Unknown, n (%)	29 (2.2)	893 (3.0)	
Disease history			
Heart failure, n (%)	343 (25.6)	5,217 (17.6)	0.197
CAD, n (%)	314 (23.5)	5,307 (17.9)	0.139
COPD, n (%)	379 (28.3)	5,812 (19.6)	0.206
Hyperlipidemia, n (%)	735 (54.9)	13,509 (45.4)	0.190
Hypertension, n (%)	907 (67.7)	16,903 (56.9)	0.226

Atrial fibrillation, n (%)	299 (22.3)	4,713 (15.9)	0.165
Type 2 DM, n (%)	390 (29.1)	7,146 (24.0)	0.115
Medication			
ASA, n (%)	550 (41.1)	10,729 (36.1)	0.102
P2Y ₁₂ Inhibitor, n (%)	63 (4.7)	1,346 (4.5)	0.008
Statin	650 (48.5)	11,785 (39.6)	0.180
ACEi, n (%)	269 (20.1)	6,054 (20.4)	0.007
ARB, n (%)	193 (14.4)	3,321 (11.1)	0.098
Beta blocker, n (%)	584 (43.6)	10,499 (35.3)	0.170
Loop diuretic, n (%)	402 (30.0)	6,035 (20.3)	0.225
MRA, n (%)	69 (5.2)	1,197 (4.0)	0.054
Virus testing method			
Method			0.030
A, n (%)	695 (51.9)	14,990 (50.4)	
B, n (%)	644 (48.1)	14,736 (49.6)	

Abbreviations. SMD: standardized mean difference, CAD: coronary heart disease, COPD: chronic obstructive pulmonary disease, DM: diabetes mellitus, ASA: acetyl-salicylic acid, ACEi: angiotensin-converting enzyme inhibitor, ARB: angiotensin II receptor blocker, MRA: mineralocorticoid receptor antagonist

Table S12. Baseline characteristics for survival analysis of heart failure stratified by RSV infection (with 90 days exclusion window, matched)

	RSV positive	RSV negative	SMD
Number patients	1,263	20,208	
Demographics			
Age, years \pm SD	64.1 \pm 18.3	63.8 \pm 17.8	0.017
Gender, Male (%)	537 (42.5)	8,661 (42.9)	0.007
History of Smoking, Yes (%)	599 (47.4)	9,511 (47.1)	0.007
Race			0.012
White, n (%)	953 (75.5)	15,224 (75.3)	
Black, n (%)	123 (9.7)	2,000 (9.9)	
Hispanic, n (%)	32 (2.5)	482 (2.4)	
Asian, n (%)	43 (3.4)	702 (3.5)	
Others, n (%)	87 (6.9)	1,391 (6.9)	
Unknown, n (%)	25 (2.0)	409 (2.0)	
Disease history			
Heart failure, n (%)	272 (21.5)	3,969 (19.6)	0.047
CAD, n (%)	271 (21.5)	4,202 (20.8)	0.016
COPD, n (%)	347 (27.5)	5,111 (25.3)	0.050
Hyperlipidemia, n (%)	671 (53.1)	10,652 (52.7)	0.008
Hypertension, n (%)	837 (66.3)	13,315 (65.9)	0.008

Atrial fibrillation, n (%)	257 (14.5)	3,817 (18.9)	0.037
Type 2 DM, n (%)	351 (23.3)	5,534 (27.4)	0.009
Medication			
ASA, n (%)	500 (39.6)	8,050 (39.8)	0.005
P2Y ₁₂ Inhibitor, n (%)	58 (4.6)	947 (4.7)	0.004
Statin	589 (46.6)	9,317 (46.1)	0.011
ACEi, n (%)	248 (19.6)	4,669 (23.1)	0.085
ARB, n (%)	176 (13.9)	2,669 (13.2)	0.021
Beta blocker, n (%)	525 (41.6)	8,105 (40.1)	0.030
Loop diuretic, n (%)	336 (26.6)	4,874 (24.1)	0.057
MRA, n (%)	54 (4.3)	861 (4.3)	0.001
Virus testing method			
Method			0.005
A, n (%)	652 (51.6)	10,379 (51.4)	
B, n (%)	611 (48.4)	9,829 (48.6)	

Abbreviations. SMD: standardized mean difference, CAD: coronary heart disease, COPD: chronic obstructive pulmonary disease, DM: diabetes mellitus, ASA: acetyl-salicylic acid, ACEi: angiotensin-converting enzyme inhibitor, ARB: angiotensin II receptor blocker, MRA: mineralocorticoid receptor antagonist

Table S13. Baseline characteristics for survival analysis of urgent revascularization stratified by RSV infection (with 90 days exclusion window, matched)

	RSV positive	RSV negative	SMD
Number patients	1,340	21,440	
Demographics			
Age, years \pm SD	64.6 \pm 18.2	64.2 \pm 17.7	0.022
Gender, Male (%)	568 (42.4)	9,202 (42.9)	0.011
History of Smoking, Yes (%)	645 (48.1)	10,238 (47.8)	0.008
Race			0.011
White, n (%)	1,008 (75.2)	16,094 (75.1)	
Black, n (%)	134 (10.0)	2,202 (10.3)	
Hispanic, n (%)	33 (2.5)	517 (2.4)	
Asian, n (%)	43 (3.2)	699 (3.3)	
Others, n (%)	93 (6.9)	1,474 (6.9)	
Unknown, n (%)	29 (2.2)	454 (2.1)	
Disease history			
Heart failure, n (%)	342 (25.5)	4,926 (23.0)	0.059
CAD, n (%)	311 (23.2)	4,736 (22.1)	0.027
COPD, n (%)	381 (28.4)	5,564 (26.0)	0.056
Hyperlipidemia, n (%)	732 (54.6)	11,604 (54.1)	0.010
Hypertension, n (%)	909 (67.8)	14,411 (67.2)	0.013

Atrial fibrillation, n (%)	298 (22.2)	4,378 (20.4)	0.044
Type 2 DM, n (%)	391 (23.3)	6,141 (28.6)	0.012
Medication			
ASA, n (%)	548 (40.9)	8,804 (41.1)	0.003
P2Y ₁₂ Inhibitor, n (%)	61 (4.6)	1,013 (4.7)	0.008
Statin	647 (48.3)	10,191 (47.5)	0.015
ACEi, n (%)	271 (20.2)	5,110 (23.8)	0.087
ARB, n (%)	193 (14.4)	2,905 (13.5)	0.025
Beta blocker, n (%)	583 (43.5)	8,977 (41.9)	0.033
Loop diuretic, n (%)	403 (30.1)	6,055 (20.3)	0.226
MRA, n (%)	69 (5.1)	1,047 (4.9)	0.012
Virus testing method			
Method			0.001
A, n (%)	693 (51.7)	11,100 (51.8)	
B, n (%)	647 (48.3)	10,340 (48.2)	

Abbreviations. SMD: standardized mean difference, CAD: coronary heart disease, COPD: chronic obstructive pulmonary disease, DM: diabetes mellitus, ASA: acetyl-salicylic acid, ACEi: angiotensin-converting enzyme inhibitor, ARB: angiotensin II receptor blocker, MRA: mineralocorticoid receptor antagonist

Table S14. Baseline characteristics for survival analysis of ischemic stroke stratified by RSV infection (with 90 days exclusion window, matched)

	RSV positive	RSV negative	SMD
Number patients	1,339	21,424	
Demographics			
Age, years \pm SD	64.6 \pm 18.2	64.2 \pm 17.7	0.024
Gender, Male (%)	569 (42.5)	9,218 (43.0)	0.011
History of Smoking, Yes (%)	644 (48.1)	10,218 (47.7)	0.008
Race			0.008
White, n (%)	1,006 (75.1)	16,117 (75.2)	
Black, n (%)	135 (10.1)	2,152 (10.0)	
Hispanic, n (%)	33 (2.5)	518 (2.4)	
Asian, n (%)	43 (3.2)	700 (3.3)	
Others, n (%)	93 (6.9)	1,492 (7.0)	
Unknown, n (%)	29 (2.2)	445 (2.1)	
Disease history			
Heart failure, n (%)	343 (25.6)	4,906 (22.9)	0.063
CAD, n (%)	314 (23.5)	4,813 (22.5)	0.023
COPD, n (%)	379 (28.3)	5,519 (25.8)	0.057
Hyperlipidemia, n (%)	735 (54.9)	11,668 (54.5)	0.009
Hypertension, n (%)	907 (67.7)	14,452 (67.5)	0.006

Atrial fibrillation, n (%)	299 (22.3)	4,391 (20.5)	0.045
Type 2 DM, n (%)	390 (29.1)	6,108 (28.5)	0.014
Medication			
ASA, n (%)	550 (41.1)	8,852 (41.3)	0.005
P2Y ₁₂ Inhibitor, n (%)	63 (4.7)	1,045 (4.9)	0.008
Statin	650 (48.5)	10,218 (47.7)	0.017
ACEi, n (%)	269 (20.1)	5,089 (23.8)	0.089
ARB, n (%)	193 (14.4)	2,898 (13.5)	0.026
Beta blocker, n (%)	584 (43.6)	9,025 (42.1)	0.030
Loop diuretic, n (%)	402 (30.0)	5,749 (26.8)	0.071
MRA, n (%)	69 (5.2)	1,045 (4.9)	0.013
Virus testing method			
Method			0.001
A, n (%)	695 (51.9)	11,135 (52.0)	
B, n (%)	644 (48.1)	10,289 (48.0)	

Abbreviations. SMD: standardized mean difference, CAD: coronary heart disease, COPD: chronic obstructive pulmonary disease, DM: diabetes mellitus, ASA: acetyl-salicylic acid, ACEi: angiotensin-converting enzyme inhibitor, ARB: angiotensin II receptor blocker, MRA: mineralocorticoid receptor antagonist

Table S15. Baseline characteristics for survival analysis of heart failure hospitalization stratified by influenza infection (unmatched)

	influenza positive	influenza negative	SMD
Number patients	5138	53,384	
Demographics			
Age, years \pm SD	55.2 \pm 19.8	58.6 \pm 19.5	0.172
Gender, Male (%)	1,867 (36.3)	22,599 (42.3)	0.123
History of Smoking, Yes (%)	1,720 (33.5)	22,900 (42.9)	0.195
Race			0.084
White, n (%)	3,702 (72.1)	39,644 (74.3)	
Black, n (%)	424 (8.3)	4,877 (9.1)	
Hispanic, n (%)	169 (3.3)	1,422 (2.7)	
Asian, n (%)	220 (4.3)	1,906 (3.6)	
Others, n (%)	420 (8.2)	3,833 (7.2)	
Unknown, n (%)	203 (4.0)	1,702 (3.2)	
Disease history			
Heart failure, n (%)	425 (8.3)	7,387 (13.8)	0.178
CAD, n (%)	541 (10.5)	8,086 (15.1)	0.138
COPD, n (%)	639 (12.4)	9,657 (18.1)	0.158
Hyperlipidemia, n (%)	2,035 (39.6)	22,652 (42.4)	0.057
Hypertension, n (%)	2,179 (42.4)	27,570 (51.6)	0.186
Atrial fibrillation, n (%)	460 (9.0)	7,406 (13.9)	0.155

Type 2 DM, n (%)	864 (16.8)	11,210 (21.0)	0.107
Medication			
ASA, n (%)	1,326 (25.8)	17,379 (32.6)	0.149
P2Y ₁₂ Inhibitor, n (%)	145 (2.8)	2,104 (3.9)	0.062
Statin	1,577 (30.7)	19,265 (36.1)	0.115
ACEi, n (%)	779 (15.2)	9,894 (18.5)	0.090
ARB, n (%)	451 (8.8)	5,462 (10.2)	0.050
Beta blocker, n (%)	1137 (22.1)	16,798 (31.5)	0.212
Loop diuretic, n (%)	529 (10.3)	9,263 (17.4)	0.206
MRA, n (%)	117 (2.3)	1,840 (3.4)	0.070
Virus testing method			
Method			0.724
A, n (%)	3,133 (61.0)	17,285 (32.4)	
B, n (%)	725 (14.1)	5,016 (9.4)	
C, n (%)	720 (14.0)	16,196 (30.3)	
D, n (%)	560 (10.9)	14,887 (27.9)	

Abbreviations. SMD: standardized mean difference, CAD: coronary heart disease, COPD: chronic obstructive pulmonary disease, DM: diabetes mellitus, ASA: acetyl-salicylic acid, ACEi: angiotensin-converting enzyme inhibitor, ARB: angiotensin II receptor blocker, MRA: mineralocorticoid receptor antagonist

Table S16. Baseline characteristics for survival analysis of urgent revascularization stratified by influenza infection (unmatched)

	influenza positive	influenza negative	SMD
Number patients	5,176	54,418	
Demographics			
Age, years \pm SD	55.4 \pm 19.8	58.9 \pm 19.6	0.177
Gender, Male (%)	1,886 (36.4)	23,097 (42.4)	0.123
History of Smoking, Yes (%)	1,743 (33.7)	23,496 (43.2)	0.196
Race			0.087
White, n (%)	3,733 (72.1)	40,475 (74.4)	
Black, n (%)	425 (8.2)	4,973 (9.1)	
Hispanic, n (%)	170 (3.3)	1,439 (2.6)	
Asian, n (%)	224 (4.3)	1,931 (3.5)	
Others, n (%)	420 (8.1)	3,876 (7.1)	
Unknown, n (%)	204 (3.9)	1,724 (3.2)	
Disease history			
Heart failure, n (%)	457 (8.8)	8,107 (14.9)	0.189
CAD, n (%)	560 (10.8)	8,481 (15.6)	0.141
COPD, n (%)	657 (12.4)	10,029 (18.4)	0.159
Hyperlipidemia, n (%)	2,060 (39.8)	23,315 (42.8)	0.062
Hypertension, n (%)	2,211 (42.7)	28,435 (52.3)	0.192
Atrial fibrillation, n (%)	487 (9.4)	7,902 (14.5)	0.158

Type 2 DM, n (%)	881 (17.0)	11,613 (21.3)	0.110
Medication			
ASA, n (%)	1,353 (26.1)	17,945 (33.0)	0.150
P2Y ₁₂ Inhibitor, n (%)	147 (2.8)	2,201 (4.0)	0.066
Statin	1,604 (31.0)	19,891 (36.6)	0.118
ACEi, n (%)	787 (15.2)	10,177 (18.7)	0.093
ARB, n (%)	457 (8.8)	5,647 (10.4)	0.053
Beta blocker, n (%)	1,164 (22.5)	17,478 (32.1)	0.217
Loop diuretic, n (%)	561 (10.8)	9,950 (18.3)	0.212
MRA, n (%)	123 (2.4)	1,947 (3.6)	0.071
Virus testing method			
Method			0.728
A, n (%)	3,152 (60.9)	17,486 (32.1)	
B, n (%)	726 (14.0)	5,039 (9.3)	
C, n (%)	734 (14.2)	16,632 (30.6)	
D, n (%)	564 (10.9)	15,261 (28.0)	

Abbreviations. SMD: standardized mean difference, CAD: coronary heart disease, COPD: chronic obstructive pulmonary disease, DM: diabetes mellitus, ASA: acetyl-salicylic acid, ACEi: angiotensin-converting enzyme inhibitor, ARB: angiotensin II receptor blocker, MRA: mineralocorticoid receptor antagonist

Table S17. Baseline characteristics for survival analysis of stroke stratified by influenza infection (unmatched)

	influenza positive	influenza negative	SMD
Number patients	5,172	54,351	
Demographics			
Age, years \pm SD	55.3 \pm 19.8	58.8 \pm 19.6	0.178
Gender, Male (%)	1,885 (36.4)	23,077 (42.5)	0.123
History of Smoking, Yes (%)	1,742 (33.7)	23,479 (43.2)	0.197
Race			0.088
White, n (%)	3,730 (72.1)	40,434 (74.4)	
Black, n (%)	424 (8.2)	4,959 (9.1)	
Hispanic, n (%)	170 (3.3)	1,440 (2.6)	
Asian, n (%)	224 (4.3)	1,924 (3.5)	
Others, n (%)	420 (8.1)	3,875 (7.1)	
Unknown, n (%)	204 (3.9)	1,719 (3.2)	
Disease history			
Heart failure, n (%)	456 (8.8)	8,095 (14.9)	0.189
CAD, n (%)	563 (10.9)	8,488 (15.6)	0.140
COPD, n (%)	658 (12.4)	10,009 (18.4)	0.158
Hyperlipidemia, n (%)	2,059 (39.8)	23,281 (42.8)	0.061
Hypertension, n (%)	2,207 (42.7)	28,385 (52.2)	0.192
Atrial fibrillation, n (%)	485 (9.4)	7,876 (14.5)	0.158

Type 2 DM, n (%)	881 (17.0)	11,589 (21.3)	0.109
Medication			
ASA, n (%)	1,353 (26.2)	17,913 (33.0)	0.149
P2Y ₁₂ Inhibitor, n (%)	147 (2.8)	2,191 (4.0)	0.065
Statin	1,601 (31.0)	19,855 (36.5)	0.118
ACEi, n (%)	787 (15.2)	10,151 (18.7)	0.092
ARB, n (%)	456 (8.8)	5,639 (10.4)	0.053
Beta blocker, n (%)	1,167 (22.6)	17,443 (32.1)	0.215
Loop diuretic, n (%)	559 (10.8)	9,934 (18.3)	0.213
MRA, n (%)	122 (2.4)	1,951 (3.6)	0.072
Virus testing method			
Method			0.727
A, n (%)	3,149 (60.9)	17,475 (32.2)	
B, n (%)	725 (14.0)	5,038 (9.3)	
C, n (%)	733 (14.2)	16,602 (30.5)	
D, n (%)	565 (10.9)	15,236 (28.0)	

Abbreviations. SMD: standardized mean difference, CAD: coronary heart disease, COPD: chronic obstructive pulmonary disease, DM: diabetes mellitus, ASA: acetyl-salicylic acid, ACEi: angiotensin-converting enzyme inhibitor, ARB: angiotensin II receptor blocker, MRA: mineralocorticoid receptor antagonist

Table S18. Baseline characteristics for survival analysis of heart failure hospitalization stratified by influenza infection (matched)

	influenza positive	influenza negative	SMD
Number patients	5,138	25,690	
Demographics			
Age, years \pm SD	55.2 \pm 19.8	55.1 \pm 19.6	0.007
Gender, Male (%)	1,867 (36.3)	9,313 (36.3)	0.002
History of Smoking, Yes (%)	1,720 (33.5)	8,674 (33.8)	0.006
Race			0.021
White, n (%)	3,702 (72.1)	18,559 (72.2)	
Black, n (%)	424 (8.3)	2,167 (8.4)	
Hispanic, n (%)	169 (3.3)	844 (3.3)	
Asian, n (%)	220 (4.3)	1,049 (4.1)	
Others, n (%)	420 (8.2)	2,137 (8.3)	
Unknown, n (%)	203 (4.0)	934 (3.6)	
Disease history			
Heart failure, n (%)	425 (8.3)	2,159 (8.4)	0.005
CAD, n (%)	541 (10.5)	2,719 (10.6)	0.002
COPD, n (%)	639 (12.4)	3,268 (12.7)	0.009
Hyperlipidemia, n (%)	2,035 (39.6)	10,036 (39.1)	0.011
Hypertension, n (%)	2,179 (42.4)	10,902 (42.4)	0.001
Atrial fibrillation, n (%)	460 (9.0)	2,319 (9.0)	0.003

Type 2 DM, n (%)	864 (16.8)	4,376 (17.0)	0.006
Medication			
ASA, n (%)	1,326 (25.8)	6,608 (25.7)	0.002
P2Y ₁₂ Inhibitor, n (%)	145 (2.8)	708 (2.8)	0.004
Statin	1,577 (30.7)	7,562 (29.4)	0.027
ACEi, n (%)	779 (15.2)	3,931 (15.3)	0.004
ARB, n (%)	451 (8.8)	2,177 (8.5)	0.011
Beta blocker, n (%)	1137 (22.1)	6,151 (23.9)	0.043
Loop diuretic, n (%)	529 (10.3)	2,729 (10.3)	0.011
MRA, n (%)	117 (2.3)	653 (2.5)	0.017
Virus testing method			
Method			0.028
A, n (%)	3,133 (61.0)	15,478 (60.2)	
B, n (%)	725 (14.1)	3,801 (14.8)	
C, n (%)	720 (14.0)	3,729 (14.5)	
D, n (%)	560 (10.9)	2,682 (10.4)	

Abbreviations. SMD: standardized mean difference, CAD: coronary heart disease, COPD: chronic obstructive pulmonary disease, DM: diabetes mellitus, ASA: acetyl-salicylic acid, ACEi: angiotensin-converting enzyme inhibitor, ARB: angiotensin II receptor blocker, MRA: mineralocorticoid receptor antagonist

Table S19. Baseline characteristics for survival analysis of urgent revascularization stratified by influenza infection (matched)

	influenza positive	influenza negative	SMD
Number patients	5,176	25,880	
Demographics			
Age, years \pm SD	55.4 \pm 19.8	55.1 \pm 19.7	0.013
Gender, Male (%)	1,886 (36.4)	9,522 (36.8)	0.007
History of Smoking, Yes (%)	1,743 (33.7)	8,776 (33.9)	0.005
Race			0.017
White, n (%)	3,733 (72.1)	18,703 (72.3)	
Black, n (%)	425 (8.2)	2,111 (8.2)	
Hispanic, n (%)	170 (3.3)	834 (3.2)	
Asian, n (%)	224 (4.3)	1,076 (4.2)	
Others, n (%)	420 (8.1)	2,184 (8.4)	
Unknown, n (%)	204 (3.9)	972 (3.8)	
Disease history			
Heart failure, n (%)	457 (8.8)	2,245 (8.7)	0.005
CAD, n (%)	560 (10.8)	2,782 (10.7)	0.002
COPD, n (%)	657 (12.4)	3,320 (12.8)	0.004
Hyperlipidemia, n (%)	2,060 (39.8)	10,073 (38.9)	0.018
Hypertension, n (%)	2,211 (42.7)	11,017 (42.6)	0.003
Atrial fibrillation, n (%)	487 (9.4)	2,499 (9.7)	0.008

Type 2 DM, n (%)	881 (17.0)	4,386 (16.9)	0.002
Medication			
ASA, n (%)	1,353 (26.1)	6,792 (26.2)	0.002
P2Y ₁₂ Inhibitor, n (%)	147 (2.8)	721 (2.8)	0.003
Statin	1,604 (31.0)	7,740 (29.9)	0.024
ACEi, n (%)	787 (15.2)	3,920 (15.1)	0.002
ARB, n (%)	457 (8.8)	2,232 (8.6)	0.007
Beta blocker, n (%)	1,164 (22.5)	6,208 (24.0)	0.036
Loop diuretic, n (%)	561 (10.8)	2,780 (10.7)	0.003
MRA, n (%)	123 (2.4)	643 (2.5)	0.007
Virus testing method			
Method			0.027
A, n (%)	3,152 (60.9)	15,543 (60.1)	
B, n (%)	726 (14.0)	3,835 (14.8)	
C, n (%)	734 (14.2)	3,757 (14.5)	
D, n (%)	564 (10.9)	2,745 (10.6)	

Abbreviations. SMD: standardized mean difference, CAD: coronary heart disease, COPD: chronic obstructive pulmonary disease, DM: diabetes mellitus, ASA: acetyl-salicylic acid, ACEi: angiotensin-converting enzyme inhibitor, ARB: angiotensin II receptor blocker, MRA: mineralocorticoid receptor antagonist

Table S20. Baseline characteristics for survival analysis of stroke stratified by influenza infection (matched)

	influenza positive	influenza negative	SMD
Number patients	5,172	25,860	
Demographics			
Age, years \pm SD	55.3 \pm 19.8	55.1 \pm 19.7	0.011
Gender, Male (%)	1,885 (36.4)	9,484 (36.7)	0.005
History of Smoking, Yes (%)	1,742 (33.7)	8,778 (33.9)	0.006
Race			0.023
White, n (%)	3,730 (72.1)	18,688 (72.3)	
Black, n (%)	424 (8.2)	2,139 (8.3)	
Hispanic, n (%)	170 (3.3)	839 (3.2)	
Asian, n (%)	224 (4.3)	1,058 (4.1)	
Others, n (%)	420 (8.1)	2,192 (8.5)	
Unknown, n (%)	204 (3.9)	944 (3.7)	
Disease history			
Heart failure, n (%)	456 (8.8)	2,278 (8.8)	<0.001
CAD, n (%)	563 (10.9)	2,814 (10.9)	<0.001
COPD, n (%)	658 (12.4)	3,366 (13.0)	0.009
Hyperlipidemia, n (%)	2,059 (39.8)	10,139 (39.8)	0.012
Hypertension, n (%)	2,207 (42.7)	11,050 (42.7)	0.001
Atrial fibrillation, n (%)	485 (9.4)	2,417 (9.3)	0.001

Type 2 DM, n (%)	881 (17.0)	881 (17.0)	0.003
Medication			
ASA, n (%)	1,353 (26.2)	6,777 (26.2)	0.001
P2Y ₁₂ Inhibitor, n (%)	147 (2.8)	745 (2.9)	0.002
Statin	1,601 (31.0)	7,704 (29.8)	0.025
ACEi, n (%)	787 (15.2)	3,966 (15.3)	0.003
ARB, n (%)	456 (8.8)	2,173 (8.4)	0.015
Beta blocker, n (%)	1,167 (22.6)	6,243 (24.1)	0.037
Loop diuretic, n (%)	559 (10.8)	2,805 (10.8)	0.001
MRA, n (%)	122 (2.4)	683 (2.6)	0.018
Virus testing method			
Method			0.024
A, n (%)	3,149 (60.9)	15,548 (60.1)	
B, n (%)	725 (14.0)	3,813 (14.7)	
C, n (%)	733 (14.2)	3,741 (14.5)	
D, n (%)	565 (10.9)	2,758 (10.7)	

Abbreviations. SMD: standardized mean difference, CAD: coronary heart disease, COPD: chronic obstructive pulmonary disease, DM: diabetes mellitus, ASA: acetyl-salicylic acid, ACEi: angiotensin-converting enzyme inhibitor, ARB: angiotensin II receptor blocker, MRA: mineralocorticoid receptor antagonist

Table S21. Baseline characteristics for survival analysis of heart failure stratified by influenza infection (with 90 days exclusion window, unmatched)

	influenza positive	influenza negative	SMD
Number patients	4,877	46,856	
Demographics			
Age, years \pm SD	55.1 \pm 19.6	58.0 \pm 19.4	0.145
Gender, Male (%)	1,760 (36.1)	19,533 (41.7)	0.115
History of Smoking, Yes (%)	1,626 (33.3)	19,878 (42.4)	0.188
Race			0.078
White, n (%)	3,517 (72.1)	34,621 (73.9)	
Black, n (%)	406 (8.3)	4,362 (9.3)	
Hispanic, n (%)	157 (3.2)	1,312 (2.8)	
Asian, n (%)	209 (4.3)	1,675 (3.6)	
Others, n (%)	396 (8.1)	3,421 (7.3)	
Unknown, n (%)	192 (3.9)	1,465 (3.1)	
Disease history			
Heart failure, n (%)	391 (8.0)	6,118 (13.1)	0.165
CAD, n (%)	527 (10.8)	7,003 (14.9)	0.124
COPD, n (%)	628 (12.9)	8,535 (18.2)	0.148
Hyperlipidemia, n (%)	1,984 (40.7)	20,076 (42.8)	0.044

Hypertension, n (%)	2,094 (42.9)	24,185 (51.6)	0.175
Atrial fibrillation, n (%)	432 (8.9)	6,248 (13.3)	0.143
Type 2 DM, n (%)	822 (16.9)	9,727 (20.8)	0.100
Medication			
ASA, n (%)	1,269 (26.0)	15,062 (32.1)	0.135
P2Y ₁₂ Inhibitor, n (%)	137 (2.8)	1,756 (3.7)	0.053
Statin	1,506 (30.9)	16,554 (35.3)	0.095
ACEi, n (%)	744 (15.3)	8,642 (18.4)	0.085
ARB, n (%)	429 (8.8)	4,723 (10.1)	0.044
Beta blocker, n (%)	1,067 (21.9)	14,247 (30.4)	0.195
Loop diuretic, n (%)	478 (9.8)	7,450 (15.9)	0.183
MRA, n (%)	104 (2.1)	1,490 (3.2)	0.065
Virus testing method			
Method			0.694
A, n (%)	3,027 (62.1)	16,119 (34.4)	
B, n (%)	696 (14.3)	4,748 (10.1)	
C, n (%)	654 (13.4)	13,819 (29.5)	
D, n (%)	500 (10.3)	12,170 (26.0)	

Abbreviations. SMD: standardized mean difference, CAD: coronary heart disease, COPD: chronic obstructive pulmonary disease, DM: diabetes mellitus, ASA: acetyl-salicylic acid, ACEi: angiotensin-converting enzyme inhibitor, ARB: angiotensin II receptor blocker, MRA: mineralocorticoid receptor antagonist

Table S22. Baseline characteristics for survival analysis of urgent revascularization stratified by influenza infection (with 90 days exclusion window, unmatched)

	influenza positive	influenza negative	SMD
Number patients	4,948	48,590	
Demographics			
Age, years \pm SD	55.5 \pm 19.7	58.5 \pm 19.5	0.155
Gender, Male (%)	1,792 (36.2)	20,397 (42.0)	0.118
History of Smoking, Yes (%)	1,669 (33.7)	20,853 (42.9)	0.190
Race			0.084
White, n (%)	3,569 (72.1)	36,019 (74.1)	
Black, n (%)	411 (8.3)	4,524 (9.3)	
Hispanic, n (%)	162 (3.3)	1,337 (2.8)	
Asian, n (%)	214 (4.3)	1,714 (3.5)	
Others, n (%)	398 (8.0)	3,492 (7.2)	
Unknown, n (%)	194 (3.9)	1,505 (3.1)	
Disease history			
Heart failure, n (%)	454 (9.2)	7,427 (15.3)	0.187
CAD, n (%)	559 (11.3)	7,710 (15.9)	0.134
COPD, n (%)	664 (13.4)	9,192 (18.9)	0.150
Hyperlipidemia, n (%)	2,036 (41.1)	21,238 (43.7)	0.052

Hypertension, n (%)	2,158 (43.6)	25,688 (52.9)	0.186
Atrial fibrillation, n (%)	470 (9.5)	7,115 (14.6)	0.158
Type 2 DM, n (%)	862 (17.4)	10,492 (21.6)	0.105
Medication			
ASA, n (%)	1,316 (26.6)	16,052 (33.0)	0.141
P2Y ₁₂ Inhibitor, n (%)	146 (3.0)	1,921 (4.0)	0.055
Statin	1,558 (31.5)	17,659 (36.3)	0.103
ACEi, n (%)	765 (15.5)	9,124 (18.8)	0.088
ARB, n (%)	442 (8.9)	5,040 (10.4)	0.049
Beta blocker, n (%)	1,120 (22.6)	15,434 (31.8)	0.206
Loop diuretic, n (%)	533 (10.8)	8,690 (17.9)	0.204
MRA, n (%)	114 (2.3)	1,716 (3.5)	0.073
Virus testing method			
Method			0.699
A, n (%)	3,058 (61.8)	16,488 (33.9)	
B, n (%)	699 (14.1)	4,807 (9.9)	
C, n (%)	675 (13.6)	14,527 (29.9)	
D, n (%)	516 (10.4)	12,768 (26.3)	

Abbreviations. SMD: standardized mean difference, CAD: coronary heart disease, COPD: chronic obstructive pulmonary disease, DM: diabetes mellitus, ASA: acetyl-salicylic acid, ACEi: angiotensin-converting enzyme inhibitor, ARB: angiotensin II receptor blocker, MRA: mineralocorticoid receptor antagonist

Table S23. Baseline characteristics for survival analysis of ischemic stroke stratified by influenza infection (with 90 days exclusion window, unmatched)

	influenza positive	influenza negative	SMD
Number patients	4,943	48,492	
Demographics			
Age, years \pm SD	55.4 \pm 19.6	58.5 \pm 19.5	0.155
Gender, Male (%)	1,791 (36.2)	20,359 (42.0)	0.118
History of Smoking, Yes (%)	1,666 (33.7)	20,814 (42.9)	0.190
Race			0.084
White, n (%)	3,566 (72.1)	35,956 (74.1)	
Black, n (%)	410 (8.3)	4,500 (9.3)	
Hispanic, n (%)	162 (3.3)	1,338 (2.8)	
Asian, n (%)	214 (4.3)	1,705 (3.5)	
Others, n (%)	397 (8.0)	3,492 (7.2)	
Unknown, n (%)	194 (3.9)	1,501 (3.1)	
Disease history			
Heart failure, n (%)	453 (9.2)	7,398 (15.3)	0.187
CAD, n (%)	563 (11.4)	7,723 (15.9)	0.132
COPD, n (%)	663 (13.4)	9,161 (18.9)	0.149
Hyperlipidemia, n (%)	2,035 (41.2)	21,192 (43.7)	0.051

Hypertension, n (%)	2,153 (43.6)	25,612 (52.8)	0.186
Atrial fibrillation, n (%)	471 (9.5)	7,072 (14.6)	0.156
Type 2 DM, n (%)	861 (17.4)	10,443 (21.5)	0.104
Medication			
ASA, n (%)	1,314 (26.6)	16,009 (33.0)	0.141
P2Y ₁₂ Inhibitor, n (%)	146 (3.0)	1,912 (3.9)	0.054
Statin	1,555 (31.5)	17,608 (36.3)	0.103
ACEi, n (%)	761 (15.4)	9,091 (18.7)	0.089
ARB, n (%)	443 (9.0)	5,028 (10.4)	0.048
Beta blocker, n (%)	1,120 (22.7)	15,381 (31.7)	0.205
Loop diuretic, n (%)	531 (10.7)	8,649 (17.8)	0.204
MRA, n (%)	113 (2.3)	1,711 (3.5)	0.074
Virus testing method			
Method			0.698
A, n (%)	3,054 (61.8)	16,465 (34.0)	
B, n (%)	699 (14.1)	4,800 (9.9)	
C, n (%)	673 (13.6)	14,493 (29.9)	
D, n (%)	517 (10.5)	12,734 (26.3)	

Abbreviations. SMD: standardized mean difference, CAD: coronary heart disease, COPD: chronic obstructive pulmonary disease, DM: diabetes mellitus, ASA: acetyl-salicylic acid, ACEi: angiotensin-converting enzyme inhibitor, ARB: angiotensin II receptor blocker, MRA: mineralocorticoid receptor antagonist

Table S24. Baseline characteristics for survival analysis of heart failure stratified by influenza infection (with 90 days exclusion window, matched)

	influenza positive	influenza negative	SMD
Number patients	4,877	24,385	
Demographics			
Age, years \pm SD	55.1 \pm 19.6	55.2 \pm 19.5	0.001
Gender, Male (%)	1,760 (36.1)	8,952 (36.7)	0.013
History of Smoking, Yes (%)	1,626 (33.3)	8,426 (34.6)	0.026
Race			0.022
White, n (%)	3,517 (72.1)	17,653 (72.4)	
Black, n (%)	406 (8.3)	2,093 (8.6)	
Hispanic, n (%)	157 (3.2)	764 (3.1)	
Asian, n (%)	209 (4.3)	983 (4.0)	
Others, n (%)	396 (8.1)	2,001 (8.2)	
Unknown, n (%)	192 (3.9)	891 (3.7)	
Disease history			
Heart failure, n (%)	391 (8.0)	2,029 (8.3)	0.011
CAD, n (%)	527 (10.8)	2,691 (11.0)	0.007
COPD, n (%)	628 (12.9)	3,176 (13.0)	0.004
Hyperlipidemia, n (%)	1,984 (40.7)	9,774 (40.1)	0.012

Hypertension, n (%)	2,094 (42.9)	10,610 (43.5)	0.012
Atrial fibrillation, n (%)	432 (8.9)	2,215 (9.1)	0.008
Type 2 DM, n (%)	822 (16.9)	4,166 (17.1)	0.006
Medication			
ASA, n (%)	1,269 (26.0)	6,409 (26.3)	0.006
P2Y ₁₂ Inhibitor, n (%)	137 (2.8)	672 (2.8)	0.003
Statin	1,506 (30.9)	7,249 (29.7)	0.025
ACEi, n (%)	744 (15.3)	3,748 (15.4)	0.003
ARB, n (%)	429 (8.8)	2,132 (8.7)	0.002
Beta blocker, n (%)	1,067 (21.9)	5,853 (24.0)	0.051
Loop diuretic, n (%)	478 (9.8)	2,434 (10.0)	0.006
MRA, n (%)	104 (2.1)	600 (2.5)	0.022
Virus testing method			
Method			0.023
A, n (%)	3,027 (62.1)	14,941 (61.3)	
B, n (%)	696 (14.3)	3,662 (15.0)	
C, n (%)	654 (13.4)	3,321 (13.6)	
D, n (%)	500 (10.3)	2,461 (10.1)	

Abbreviations. SMD: standardized mean difference, CAD: coronary heart disease, COPD: chronic obstructive pulmonary disease, DM: diabetes mellitus, ASA: acetyl-salicylic acid, ACEi: angiotensin-converting enzyme inhibitor, ARB: angiotensin II receptor blocker, MRA: mineralocorticoid receptor antagonist

Table S25. Baseline characteristics for survival analysis of urgent revascularization stratified by influenza infection (with 90 days exclusion window, matched)

	influenza positive	influenza negative	SMD
Number patients	4,948	24,740	
Demographics			
Age, years \pm SD	55.5 \pm 19.7	55.3 \pm 19.5	0.006
Gender, Male (%)	1,792 (36.2)	9,144 (37.0)	0.015
History of Smoking, Yes (%)	1,669 (33.7)	8,562 (34.6)	0.018
Race			0.027
White, n (%)	3,569 (72.1)	17,904 (72.4)	
Black, n (%)	411 (8.3)	2,151 (8.7)	
Hispanic, n (%)	162 (3.3)	797 (3.2)	
Asian, n (%)	214 (4.3)	970 (3.9)	
Others, n (%)	398 (8.0)	2,007 (8.1)	
Unknown, n (%)	194 (3.9)	911 (3.7)	
Disease history			
Heart failure, n (%)	454 (9.2)	2,283 (9.2)	0.002
CAD, n (%)	559 (11.3)	2,788 (11.3)	0.001
COPD, n (%)	664 (13.4)	3,419 (13.8)	0.012
Hyperlipidemia, n (%)	2,036 (41.1)	9,977 (40.3)	0.017

Hypertension, n (%)	2,158 (43.6)	10,805 (43.7)	0.001
Atrial fibrillation, n (%)	470 (9.5)	2,392 (9.7)	0.006
Type 2 DM, n (%)	862 (17.4)	4,280 (17.3)	0.003
Medication			
ASA, n (%)	1,316 (26.6)	6,596 (26.7)	0.001
P2Y ₁₂ Inhibitor, n (%)	146 (3.0)	728 (2.9)	<0.001
Statin	1,558 (31.5)	7,478 (30.2)	0.027
ACEi, n (%)	765 (15.5)	3,847 (15.5)	0.002
ARB, n (%)	442 (8.9)	2,080 (8.4)	0.019
Beta blocker, n (%)	1,120 (22.6)	6,031 (24.4)	0.041
Loop diuretic, n (%)	533 (10.8)	2,701 (10.9)	0.005
MRA, n (%)	114 (2.3)	627 (2.5)	0.015
Virus testing method			
Method			0.023
A, n (%)	3,058 (61.8)	15,087 (61.0)	
B, n (%)	699 (14.1)	3,688 (14.9)	
C, n (%)	675 (13.6)	3,407 (13.8)	
D, n (%)	516 (10.4)	2,558 (10.3)	

Abbreviations. SMD: standardized mean difference, CAD: coronary heart disease, COPD: chronic obstructive pulmonary disease, DM: diabetes mellitus, ASA: acetyl-salicylic acid, ACEi: angiotensin-converting enzyme inhibitor, ARB: angiotensin II receptor blocker, MRA: mineralocorticoid receptor antagonist

Table S26. Baseline characteristics for survival analysis of ischemic stroke stratified by influenza infection (with 90 days exclusion window, matched)

	influenza positive	influenza negative	SMD
Number patients	4,943	24,715	
Demographics			
Age, years \pm SD	55.4 \pm 19.6	55.4 \pm 19.5	0.001
Gender, Male (%)	1,791 (36.2)	9,126 (36.9)	0.014
History of Smoking, Yes (%)	1,666 (33.7)	8,550 (34.6)	0.019
Race			0.027
White, n (%)	3,566 (72.1)	17,905 (72.4)	
Black, n (%)	410 (8.3)	2,116 (8.6)	
Hispanic, n (%)	162 (3.3)	799 (3.2)	
Asian, n (%)	214 (4.3)	988 (4.0)	
Others, n (%)	397 (8.0)	2,024 (8.2)	
Unknown, n (%)	194 (3.9)	883 (3.6)	
Disease history			
Heart failure, n (%)	453 (9.2)	2,249 (9.1)	0.002
CAD, n (%)	563 (11.4)	2,806 (11.4)	0.001
COPD, n (%)	663 (13.4)	3,396 (13.7)	0.010
Hyperlipidemia, n (%)	2,035 (41.2)	10,059 (40.7)	0.010

Hypertension, n (%)	2,153 (43.6)	10,849 (43.9)	0.007
Atrial fibrillation, n (%)	471 (9.5)	2,432 (9.8)	0.011
Type 2 DM, n (%)	861 (17.4)	4,305 (17.4)	<0.001
Medication			
ASA, n (%)	1,314 (26.6)	6,645 (26.9)	0.007
P2Y ₁₂ Inhibitor, n (%)	146 (3.0)	721 (2.9)	0.002
Statin	1,555 (31.5)	7,541 (30.5)	0.020
ACEi, n (%)	761 (15.4)	3,818 (15.4)	0.001
ARB, n (%)	443 (9.0)	2,181 (8.8)	0.005
Beta blocker, n (%)	1,120 (22.7)	5,987 (24.2)	0.037
Loop diuretic, n (%)	531 (10.7)	2,671 (10.8)	0.002
MRA, n (%)	113 (2.3)	636 (2.6)	0.019
Virus testing method			
Method			0.027
A, n (%)	3,054 (61.8)	15,035 (60.8)	
B, n (%)	699 (14.1)	3,720 (15.1)	
C, n (%)	673 (13.6)	3,377 (13.7)	
D, n (%)	517 (10.5)	2,583 (10.5)	

Abbreviations. SMD: standardized mean difference, CAD: coronary heart disease, COPD: chronic obstructive pulmonary disease, DM: diabetes mellitus, ASA: acetyl-salicylic acid, ACEi: angiotensin-converting enzyme inhibitor, ARB: angiotensin II receptor blocker, MRA: mineralocorticoid receptor antagonist

Table S26. History of heart failure based on the model with various cutoffs for heart failure hospitalization analysis on RSV infection (unmatched)

	RSV positive	RSV negative	SMD
Number patients	1531	33,525	
Disease history			
Model based heart failure, n (%) cutoff = 0.24	846 (55.3)	15,327 (45.7)	0.192
Model based heart failure, n (%) cutoff = 0.41	744 (48.6)	13,141 (39.2)	0.190
Model based heart failure, n (%) cutoff = 0.43	381 (24.9)	5,484 (16.4)	0.212

Table S27. Baseline characteristics for survival analysis of heart failure hospitalization stratified by RSV infection (matched, model-based heart failure history with cutoff 0.24)

	RSV positive	RSV negative	SMD
Number patients	1531	24,496	
Demographics			
Age, years \pm SD	64.6 \pm 18.3	64.1 \pm 17.7	0.026
Gender, Male (%)	643 (42.0)	10,438 (42.6)	0.012
History of Smoking, Yes (%)	731 (47.7)	11,644 (47.5)	0.004
Race			0.013
White, n (%)	1,143 (74.7)	18,219 (74.4)	
Black, n (%)	156 (10.2)	2,541 (10.4)	
Hispanic, n (%)	43 (2.8)	679 (2.8)	
Asian, n (%)	49 (3.2)	770 (3.1)	
Others, n (%)	107 (7.0)	1,776 (7.3)	
Unknown, n (%)	33 (2.2)	511 (2.1)	
Disease history			
Heart failure (model-based), n (%)	846 (55.3)	13,099 (53.5)	0.036
CAD, n (%)	361 (23.6)	5,292 (21.6)	0.047

COPD, n (%)	413 (27.0)	5,963 (24.3)	0.060
Hyperlipidemia, n (%)	823 (53.8)	12,880 (52.6)	0.024
Hypertension, n (%)	1,014 (66.2)	15,967 (65.2)	0.022
Atrial fibrillation, n (%)	332 (21.7)	4,765 (19.5)	0.055
Type 2 DM, n (%)	444 (29.0)	6,890 (28.1)	0.019
Medication			
ASA, n (%)	626 (40.9)	9,956 (40.6)	0.005
P2Y ₁₂ Inhibitor, n (%)	74 (4.8)	1,205 (4.9)	0.004
Statin	718 (46.9)	11,484 (46.9)	<0.001
ACEi, n (%)	300 (19.6)	5,686 (23.2)	0.088
ARB, n (%)	215 (14.0)	3,192 (13.0)	0.030
Beta blocker, n (%)	654 (42.7)	10,166 (41.5)	0.025
Loop diuretic, n (%)	445 (29.1)	6,288 (25.7)	0.076
MRA, n (%)	71 (4.6)	1,169 (4.8)	0.006
Virus testing method			
Method			0.004
A, n (%)	784 (51.2)	12,588 (51.4)	
B, n (%)	747 (48.8)	11,908 (48.6)	

Abbreviations. SMD: standardized mean difference, CAD: coronary heart disease, COPD: chronic obstructive pulmonary disease, DM: diabetes mellitus, ASA: acetyl-salicylic acid, ACEi: angiotensin-converting enzyme inhibitor, ARB: angiotensin II receptor blocker, MRA: mineralocorticoid receptor antagonist

Table S28. Baseline characteristics for survival analysis of heart failure hospitalization stratified by RSV infection (matched, model-based heart failure history with cutoff 0.41)

	RSV positive	RSV negative	SMD
Number patients	1531	24,496	
Demographics			
Age, years \pm SD	64.6 \pm 18.3	64.1 \pm 17.7	0.026
Gender, Male (%)	643 (42.0)	10,450 (42.7)	0.013
History of Smoking, Yes (%)	731 (47.7)	11,650 (47.6)	0.004
Race			0.009
White, n (%)	1,143 (74.7)	18,254 (74.5)	
Black, n (%)	156 (10.2)	2,540 (10.4)	
Hispanic, n (%)	43 (2.8)	695 (2.8)	
Asian, n (%)	49 (3.2)	779 (3.2)	
Others, n (%)	107 (7.0)	1,724 (7.0)	
Unknown, n (%)	33 (2.2)	504 (2.1)	
Disease history			
Heart failure (model-based), n (%)	744 (48.6)	11,355 (46.4)	0.045
CAD, n (%)	361 (23.6)	5,320 (21.7)	0.044

COPD, n (%)	413 (27.0)	5,981 (24.4)	0.059
Hyperlipidemia, n (%)	823 (53.8)	12,929 (52.8)	0.020
Hypertension, n (%)	1,014 (66.2)	16,005 (65.3)	0.019
Atrial fibrillation, n (%)	332 (21.7)	4,724 (19.3)	0.060
Type 2 DM, n (%)	444 (29.0)	6,871 (28.0)	0.021
Medication			
ASA, n (%)	626 (40.9)	9,989 (40.8)	0.002
P2Y ₁₂ Inhibitor, n (%)	74 (4.8)	1,211 (4.9)	0.005
Statin	718 (46.9)	11,538 (47.1)	0.004
ACEi, n (%)	300 (19.6)	5,663 (23.1)	0.086
ARB, n (%)	215 (14.0)	3,212 (13.1)	0.027
Beta blocker, n (%)	654 (42.7)	10,138 (41.4)	0.027
Loop diuretic, n (%)	445 (29.1)	6,263 (25.6)	0.079
MRA, n (%)	71 (4.6)	1,165 (4.8)	0.006
Virus testing method			
Method			0.005
A, n (%)	784 (51.2)	12,601 (51.2)	
B, n (%)	747 (48.8)	11,895 (48.8)	

Abbreviations. SMD: standardized mean difference, CAD: coronary heart disease, COPD: chronic obstructive pulmonary disease, DM: diabetes mellitus, ASA: acetyl-salicylic acid, ACEi: angiotensin-converting enzyme inhibitor, ARB: angiotensin II receptor blocker, MRA: mineralocorticoid receptor antagonist

Table S29. Baseline characteristics for survival analysis of heart failure hospitalization stratified by RSV infection (matched, model-based heart failure history with cutoff 0.43)

	RSV positive	RSV negative	SMD
Number patients	1531	24,496	
Demographics			
Age, years \pm SD	64.6 \pm 18.3	64.1 \pm 17.7	0.028
Gender, Male (%)	643 (42.0)	10,368 (42.3)	0.007
History of Smoking, Yes (%)	731 (47.7)	11,560 (47.2)	0.011
Race			0.012
White, n (%)	1,143 (74.7)	18,188 (74.2)	
Black, n (%)	156 (10.2)	2,508 (10.2)	
Hispanic, n (%)	43 (2.8)	717 (2.9)	
Asian, n (%)	49 (3.2)	812 (3.3)	
Others, n (%)	107 (7.0)	1,750 (7.1)	
Unknown, n (%)	33 (2.2)	521 (2.1)	
Disease history			
Heart failure (model-based), n (%)	381 (24.9)	5,232 (21.4)	0.084
CAD, n (%)	361 (23.6)	5,258 (21.5)	0.051

COPD, n (%)	413 (27.0)	5,928 (24.2)	0.064
Hyperlipidemia, n (%)	823 (53.8)	12,870 (52.5)	0.024
Hypertension, n (%)	1,014 (66.2)	16,028 (65.4)	0.017
Atrial fibrillation, n (%)	332 (21.7)	4,730 (19.3)	0.059
Type 2 DM, n (%)	444 (29.0)	6,587 (28.0)	0.022
Medication			
ASA, n (%)	626 (40.9)	9,936 (40.6)	0.007
P2Y ₁₂ Inhibitor, n (%)	74 (4.8)	1,213 (5.0)	0.005
Statin	718 (46.9)	11,488 (46.9)	<0.001
ACEi, n (%)	300 (19.6)	5,676 (23.2)	0.087
ARB, n (%)	215 (14.0)	3,213 (13.1)	0.027
Beta blocker, n (%)	654 (42.7)	10,118 (41.3)	0.029
Loop diuretic, n (%)	445 (29.1)	6,246 (25.5)	0.080
MRA, n (%)	71 (4.6)	1,154 (4.7)	0.003
Virus testing method			
Method			0.006
A, n (%)	784 (51.2)	12,623 (51.5)	
B, n (%)	747 (48.8)	11,873 (48.5)	

Abbreviations. SMD: standardized mean difference, CAD: coronary heart disease, COPD: chronic obstructive pulmonary disease, DM: diabetes mellitus, ASA: acetyl-salicylic acid, ACEi: angiotensin-converting enzyme inhibitor, ARB: angiotensin II receptor blocker, MRA: mineralocorticoid receptor antagonist

Table S30. Baseline characteristics for survival analysis of heart failure hospitalization stratified by influenza infection (matched, model-based heart failure history with cutoff 0.24)

	influenza positive	influenza negative	SMD
Number patients	5138	25,690	
Demographics			
Age, years \pm SD	55.2 \pm 19.8	55.2 \pm 19.6	0.002
Gender, Male (%)	1,867 (36.3)	9,482 (36.9)	0.012
History of Smoking, Yes (%)	1,720 (33.5)	8,839 (34.4)	0.020
Race			0.022
White, n (%)	3,702 (72.1)	18,553 (72.2)	
Black, n (%)	424 (8.3)	2,166 (8.4)	
Hispanic, n (%)	169 (3.3)	821 (3.2)	
Asian, n (%)	220 (4.3)	1,042 (4.1)	
Others, n (%)	420 (8.2)	2,167 (8.4)	
Unknown, n (%)	203 (4.0)	941 (3.7)	
Disease history			
Heart failure (model-based), n (%)	1,161 (22.6)	5,774 (22.5)	0.003
CAD, n (%)	541 (10.5)	2,750 (10.7)	0.006
COPD, n (%)	639 (12.4)	3,328 (13.0)	0.016
Hyperlipidemia, n (%)	2,035 (39.6)	10,091 (39.3)	0.007

Hypertension, n (%)	2,179 (42.4)	11,042 (43.0)	0.012
Atrial fibrillation, n (%)	460 (9.0)	2,332 (9.1)	0.004
Type 2 DM, n (%)	864 (16.8)	4,335 (16.9)	0.002
Medication			
ASA, n (%)	1,326 (25.8)	6,764 (26.3)	0.012
P2Y ₁₂ Inhibitor, n (%)	145 (2.8)	772 (3.0)	0.011
Statin	1,577 (30.7)	7,691 (29.9)	0.016
ACEi, n (%)	779 (15.2)	3,962 (15.4)	0.007
ARB, n (%)	451 (8.8)	2,234 (8.7)	0.003
Beta blocker, n (%)	1137 (22.1)	6,073 (23.6)	0.036
Loop diuretic, n (%)	529 (10.3)	2,710 (10.5)	0.008
MRA, n (%)	117 (2.3)	632 (2.5)	0.012
Virus testing method			
Method			0.039
A, n (%)	3,133 (61.0)	15,312 (59.6)	
B, n (%)	725 (14.1)	3,955 (15.4)	
C, n (%)	720 (14.0)	3,659 (14.2)	
D, n (%)	560 (10.9)	2,764 (10.8)	

Abbreviations. SMD: standardized mean difference, CAD: coronary heart disease, COPD: chronic obstructive pulmonary disease, DM: diabetes mellitus, ASA: acetyl-salicylic acid, ACEi: angiotensin-converting enzyme inhibitor, ARB: angiotensin II receptor blocker, MRA: mineralocorticoid receptor antagonist

Table S31. Baseline characteristics for survival analysis of heart failure hospitalization stratified by influenza infection (matched, model-based heart failure history with cutoff 0.41)

	influenza positive	influenza negative	SMD
Number patients	5138	25,690	
Demographics			
Age, years \pm SD	55.2 \pm 19.8	55.1 \pm 19.6	0.005
Gender, Male (%)	1,867 (36.3)	9,427 (36.7)	0.007
History of Smoking, Yes (%)	1,720 (33.5)	8,864 (34.5)	0.022
Race			0.022
White, n (%)	3,702 (72.1)	18,603 (72.4)	
Black, n (%)	424 (8.3)	2,151 (8.4)	
Hispanic, n (%)	169 (3.3)	818 (3.2)	
Asian, n (%)	220 (4.3)	1,041 (4.1)	
Others, n (%)	420 (8.2)	2,140 (8.3)	
Unknown, n (%)	203 (4.0)	937 (3.6)	
Disease history			
Heart failure (model-based), n (%)	972 (18.9)	4,793 (18.7)	0.007
CAD, n (%)	541 (10.5)	2,631 (10.2)	0.009
COPD, n (%)	639 (12.4)	3,332 (13.0)	0.016
Hyperlipidemia, n (%)	2,035 (39.6)	9,953 (38.7)	0.018

Hypertension, n (%)	2,179 (42.4)	10,923 (42.5)	0.002
Atrial fibrillation, n (%)	460 (9.0)	2,294 (8.9)	0.001
Type 2 DM, n (%)	864 (16.8)	4,208 (16.4)	0.012
Medication			
ASA, n (%)	1,326 (25.8)	6,595 (25.7)	0.003
P2Y ₁₂ Inhibitor, n (%)	145 (2.8)	688 (2.7)	0.009
Statin	1,577 (30.7)	7,569 (29.5)	0.027
ACEi, n (%)	779 (15.2)	3,848 (15.0)	0.005
ARB, n (%)	451 (8.8)	2,196 (8.5)	0.008
Beta blocker, n (%)	1137 (22.1)	5,998 (23.3)	0.029
Loop diuretic, n (%)	529 (10.3)	2,664 (10.4)	0.002
MRA, n (%)	117 (2.3)	609 (2.4)	0.006
Virus testing method			
Method			0.029
A, n (%)	3,133 (61.0)	15,399 (59.9)	
B, n (%)	725 (14.1)	3,861 (15.0)	
C, n (%)	720 (14.0)	3,680 (14.3)	
D, n (%)	560 (10.9)	2,750 (10.7)	

Abbreviations. SMD: standardized mean difference, CAD: coronary heart disease, COPD: chronic obstructive pulmonary disease, DM: diabetes mellitus, ASA: acetyl-salicylic acid, ACEi: angiotensin-converting enzyme inhibitor, ARB: angiotensin II receptor blocker, MRA: mineralocorticoid receptor antagonist

Table S32. Baseline characteristics for survival analysis of heart failure hospitalization stratified by influenza infection (matched, model-based heart failure history with cutoff 0.43)

	influenza positive	influenza negative	SMD
Number patients	5138	25,690	
Demographics			
Age, years \pm SD	55.2 \pm 19.8	55.1 \pm 19.6	0.003
Gender, Male (%)	1,867 (36.3)	9,342 (36.4)	0.001
History of Smoking, Yes (%)	1,720 (33.5)	8,662 (33.7)	0.005
Race			0.022
White, n (%)	3,702 (72.1)	18,538 (72.2)	
Black, n (%)	424 (8.3)	2,178 (8.5)	
Hispanic, n (%)	169 (3.3)	849 (3.3)	
Asian, n (%)	220 (4.3)	1,040 (4.0)	
Others, n (%)	420 (8.2)	2,147 (8.4)	
Unknown, n (%)	203 (4.0)	938 (3.7)	
Disease history			
Heart failure (model-based), n (%)	401 (7.8)	2,049 (8.0)	0.006
CAD, n (%)	541 (10.5)	2,719 (10.6)	0.002
COPD, n (%)	639 (12.4)	3,253 (12.7)	0.007
Hyperlipidemia, n (%)	2,035 (39.6)	10,015 (39.0)	0.013

Hypertension, n (%)	2,179 (42.4)	10,888 (42.4)	0.001
Atrial fibrillation, n (%)	460 (9.0)	2,338 (9.1)	0.005
Type 2 DM, n (%)	864 (16.8)	4,302 (16.7)	0.002
Medication			
ASA, n (%)	1,326 (25.8)	6,616 (25.8)	0.001
P2Y ₁₂ Inhibitor, n (%)	145 (2.8)	707 (2.8)	0.004
Statin	1,577 (30.7)	7,572 (29.5)	0.027
ACEi, n (%)	779 (15.2)	3,882 (15.1)	0.001
ARB, n (%)	451 (8.8)	2,205 (8.6)	0.007
Beta blocker, n (%)	1137 (22.1)	6,151 (23.9)	0.043
Loop diuretic, n (%)	529 (10.3)	2,704 (10.5)	0.008
MRA, n (%)	117 (2.3)	657 (2.6)	0.018
Virus testing method			
Method			0.032
A, n (%)	3,133 (61.0)	15,449 (60.1)	
B, n (%)	725 (14.1)	3,834 (14.9)	
C, n (%)	720 (14.0)	3,738 (14.6)	
D, n (%)	560 (10.9)	2,669 (10.4)	

Abbreviations. SMD: standardized mean difference, CAD: coronary heart disease, COPD: chronic obstructive pulmonary disease, DM: diabetes mellitus, ASA: acetyl-salicylic acid, ACEi: angiotensin-converting enzyme inhibitor, ARB: angiotensin II receptor blocker, MRA: mineralocorticoid receptor antagonist