

Ozone and ultra-fine particle concentrations in a hotel quarantine facility during 222 nm far-UVC air disinfection

Petri Kalliomäki¹, Hamed Sobhani², Phillip Stratton^{3,4}, Kristen K. Coleman¹, Aditya Srikakulapu¹, Ross Salawitch³, Russell R. Dickerson³, Shengwei Zhu², Jelena Srebric² and Donald K. Milton¹

¹University of Maryland, School of Public Health, College Park, MD, USA

²University of Maryland, Department of Mechanical Engineering, College Park, MD, USA

³University of Maryland, Department of Atmospheric & Oceanic Science, College Park, MD, USA

⁴Air Resources Laboratory, National Oceanic and Atmospheric Administration (NOAA), College Park, MD, USA

Abstract

Far-UVC (222 nm UV-C light) is a promising tool to mitigate aerosol transmission of pathogens indoors. However, recent studies have raised concerns related to ozone (O₃) production and secondary chemistry. In this study, we measured indoor O₃ and ultra-fine particle (UFP, 17.5-289 nm) concentrations with and without 222 nm far-UVC (average fluence rate 1.7-1.8 μW/cm²) in a hotel quarantine facility in Baltimore (MD, USA). We obtained nearby outdoor O₃ concentrations from the Environmental Protection Agency (EPA) website. In a sealed empty guest room, the average O₃ concentrations were 3 ppb (UV off, 0.1-0.5 ACH), 16 ppb (UV on, 0.1 ACH) and 9 ppb (UV on, 0.5 ACH). In a standard guest room, the average O₃ concentrations were 12 ppb (UV off, 1.4 ACH) and 14 ppb (UV on, 1.4 ACH), and correlated with outdoor concentrations ($\rho = 0.65 - 0.74$, $p = 2 \times 10^{-12} - 2 \times 10^{-29}$). A linear regression model, adjusted for outdoor O₃, estimated that use of far-UVC lamps increased the O₃ concentration by 5.7 ppb (95% confidence interval (CI) 4.9 – 6.5 ppb) in the standard hotel room. Indoor O₃ concentrations increased with far-UVC usage, however, the concentrations remained 6-12 ppb lower, on average, than outdoors and well below EPA ambient limits. We did not find a clear relationship between indoor UFP concentrations and UV usage. Although our study was limited by absence of direct outdoor measurements of local O₃ and UFPs, our findings do not support a major impact of far-UVC on UFP concentrations in the real-world environment that we studied.

31 1. Introduction

32 Hotels have been used as quarantine facilities to mitigate the spread of severe acute respiratory
33 syndrome coronavirus 2 (SARS-CoV-2) in many countries during the coronavirus disease (COVID-19)
34 pandemic. Although individuals are quarantined in separate rooms, cross infections and intra-hotel
35 clusters have been reported¹⁻⁵, some leading to community outbreaks and lockdowns^{5,6}. Such failed
36 attempts to contain SARS-CoV-2 underscore the importance of adequate ventilation, filtration, and air
37 disinfection to mitigate pandemic respiratory virus transmission.

38 One effective mitigation measure for aerosol transmission of infections is germicidal ultraviolet
39 (GUV) air disinfection⁷⁻¹⁰. It is a well-established method and has been used for several decades¹¹.
40 Traditionally, 254 nm UV light (upper-room GUV)¹²⁻¹⁴ has been the GUV wavelength used in indoor
41 environments. However, usage of 254 nm UV light is typically limited to upper-room or in-duct
42 applications as direct exposure can cause damage to eyes and skin¹⁵⁻¹⁶ (depending on the UV intensity
43 and duration of the exposure). An alternative GUV wavelength, 222 nm far-UVC, has gained popularity in
44 air disinfection and has been studied intensively, especially since the beginning of the COVID-19
45 pandemic. It is better tolerated by eyes and skin^{17,18} (compared with conventional 254 nm GUV) and
46 effectively inactivates multiple pathogens, including SARS-CoV-2¹⁹⁻²². Due to better tolerance, 222 nm far-
47 UVC can be used in occupied zones of indoor environments and hence has the potential, for example, to
48 reduce close-range transmission more effectively than upper-room GUV.

49 However, health concerns have been raised related to far-UVC usage. Recent studies have shown
50 that 222 nm far-UVC produces O₃ and secondary chemistry that can notably affect indoor air quality,
51 particularly in spaces with low ventilation²³⁻²⁷. However, these studies are mostly limited to modelling
52 cases and laboratory experiments with only a limited number of studies investigating far-UVC generated
53 O₃ and ultra-fine particulate matter in real-world settings where far-UVC air disinfection would be
54 recommended as an added layer of protection, such as in hotel quarantine facilities and other high-risk
55 indoor venues²⁸. In this preliminary study, we take advantage of ongoing influenza transmission research
56 to examine O₃ and ultra-fine particle (UFP) concentrations in a hotel quarantine facility with and without
57 222 nm far-UVC.

58 2. Methods

59 2.1. Research site

60 This study was performed in a 23-story hotel building in downtown Baltimore (MD, USA). The hotel was
61 used as a quarantine facility during the COVID-19 pandemic, and currently in ongoing influenza
62 transmission research. The hotel has a centralized ventilation system that supplies outdoor air to the
63 hallways and extracts the air through exhaust grilles in the bathrooms. The guest rooms have thermostat
64 and motion sensor-controlled fan coil units for heating or cooling the room air (designed only to
65 recirculate the room air). The fan coil units had MERV 13 filters. All guest room windows were locked and
66 could not be opened to increase ventilation. Two rooms on the 14th floor were used in this study, both
67 equipped with portable HEPA filter units (Breathsmart 45i, Alen, TX, USA, max. CADR 245 CFM). The
68 HEPA units were run constantly on the highest fan speed to ensure good mixing. We used the HEPA filter
69 and fan coil units with and without the filters as part of testing the effect of filtering on particle
70 concentrations.

71 2.1.1. Sealed unfurnished hotel room

72 The first room, referred to as the “sealed room”, was a large guest room suite (38 m²) on the north side
73 of the building. The room had vinyl flooring and was unfurnished (i.e., no bedding or desks) aside from
74 plastic chairs and tables to place sampling equipment (see Figure 1). The room had a dehumidifier
75 (HomeLabs HME020031N, NY, USA) to control relative humidity (RH, set point at 35%). We sealed door
76 gaps, taped window joints and covered the windows with plastic sheets to ensure minimal ventilation
77 and outdoor infiltration. Hence the room had a low ventilation rate between 0.1-0.5 air changes per
78 hour (ACH), see Supporting Information for more details. The average air temperature and RH during the
79 measurements were 21.1°C and 35.3%, respectively. The room had four 222 nm far-UVC light fixtures
80 (Krypton Shield, Far-UV Inc., MO, USA) each with Krypton-Chloride excimer lamp modules (B1 module,
81 Ushio Inc, Japan). When on, the average fluence rate in the sealed room was modeled to be 1.8 μW/cm²
82 (see Supporting Information for more details).

83 2.1.2. Standard hotel room

84 The other room, referred to as the “standard room”, was a furnished single guest room (21 m²) on the
85 south side of the building. The room was fully furnished with a king bed, two desks, and carpet flooring
86 (see Figure 2). We used the room under typical operating conditions and did not seal window joints,

87 door gaps, etc. The average air exchange rate of the room was 1.4 ACH and it varied between 1.2 to 1.7
88 ACH (see Supporting Information for more details). The average air temperature and RH during the
89 measurements were 22.8°C and 23.6%, respectively. The room had three 222 nm far-UVC light fixtures
90 (Krypton Shield, Far-UV Inc., MO, USA), two with Ushio B1 modules and one with B1.5 module (Ushio
91 Inc, Japan). When on, the average UV fluence rate in the standard room was modeled to be 1.7 $\mu\text{W}/\text{cm}^2$
92 (see Supporting Information for more details).

93 2.2. Measurements

94 2.2.1. *O₃ measurements*

95 We used an O₃ monitor (TE49C, Thermo Environmental Instruments, MA, USA) to measure O₃
96 concentrations inside the rooms. The concentrations were measured with 10-s resolution and later
97 averaged over 1-min and 1-h intervals. The instrument was calibrated against a reference monitor
98 (Model TE49i-PS Ozone Primary Standard) that was compared to a reference instrument at the National
99 Institute of Standards and Technology (NIST, USA). The absolute accuracy of the instrument is
100 approximately 4 ppb at 10-s resolution and 2 ppb for hourly averages (95% Confidence Interval (CI)).

101 Outdoor O₃ concentration data (1-h resolution) was downloaded from the Environmental
102 Protection Agency (EPA) website (https://aqs.epa.gov/aqsweb/documents/data_api.html). We included
103 data from the three closest monitoring stations (12-19 km from the hotel) around the Baltimore
104 metropolitan area in our analysis (which had the highest data coverage during the time of the
105 measurements). Average O₃ concentration (of the three outdoor locations) was used in the final
106 analyses.

107 2.2.2. *Ultra-fine particle measurements*

108 We used a scanning mobility particle sizer (SMPS 3938, DMA 3081A, CPC 3756, TSI Inc., MN, USA) to
109 monitor UFP concentrations within the size range of 17.5-289 nm. The sampling resolution of the SMPS
110 system was 66 s.

111 2.2.3. *CO₂ measurements*

112 We monitored ventilation by releasing carbon dioxide (CO₂) into the rooms at a constant 0.4 L/min rate
113 (GFC171S mass flow controller, Aalborg Instruments & Controls Inc., NY, USA). We used wireless sensors
114 (Aranet4, SAF Tehnika JSC, Latvia) to measure CO₂ concentrations in the rooms, hallways and outdoors
115 (1-min resolution). The sensors were calibrated with a standard CO₂ gas with a range of concentrations

116 between 500-10,000 ppm. The CO₂ sensor accuracy is ± 30 ppm or $\pm 3\%$ of the reading (according to the
117 manufacturer). The sensors also measured ambient temperature, RH, and barometric pressure.

118 2.3. Data collection and analysis

119 We carried out measurements in the sealed room between Feb 17th – Feb 20th, 2023 (O₃ between Feb
120 16th-20th, 2023) and in the standard room between Feb 27th – Mar 10th, 2023. All data were cleaned
121 (occupied periods removed from the data, etc.) and analyzed with MATLAB. One-hour averages of the
122 data were used in final analyses. Linear regression models were calculated using fitlm-function in
123 MATLAB.

124 3. Results

125 3.1. CO₂ and O₃ concentrations in the sealed hotel room

126 CO₂ and O₃ concentrations in the sealed room are shown in Figure 3. Constant injection of 0.4 L/min CO₂
127 produced two steady-state levels with concentrations of c. 1060 ppm and c. 2400 ppm. We observed
128 that the fan coil units were pulling air into the room from the pipe chase. Consequently, the average air
129 exchange rate in the sealed room was calculated to be 0.1 ACH and 0.5 ACH when the fan coil units were
130 off and on, respectively. We did not see a similar effect in the standard room.

131 When the far-UVC lamps were off, the average O₃ concentration was 3 ppb in the sealed room
132 and 32 ppb outdoors at 0.1 ACH (fan coils off), and 3 ppb indoors and 29 ppb outdoors at 0.5 ACH (fan
133 coils on). When the UV lamps were on, the average O₃ concentration was 16 ppb indoors and 22 ppb
134 outdoors at 0.1 ACH (fan coil units off), and 9 ppb indoors and 16 ppb outdoors at 0.5 ACH (fan coil units
135 on). In general, O₃ concentrations in the sealed room showed a clear build-up and decay in relationship
136 to operation of the far-UVC lamps and the fan coil units.

137 Indoor O₃ concentrations in the sealed room (at 0.1 ACH) were strongly correlated (Spearman's
138 rank correlation ρ) with outdoor concentrations (Figure 4a) both with far-UVC lamps off ($\rho = 0.88$, $p =$
139 $7 \cdot 10^{-9}$) and on ($\rho = 0.97$, $p = 3 \cdot 10^{-10}$). When the fan coil units were on and the ventilation rate increased
140 to 0.5 ACH, indoor O₃ was weakly to moderately correlated with outdoor concentrations when the far-
141 UVC lights were off ($\rho = 0.48$, $p = 0.04$) or on ($\rho = 0.38$, $p = 0.06$) (Figure 4b).

142 3.2. CO₂ and O₃ concentrations in the standard hotel room

143 CO₂ and O₃ data collected from the standard hotel room is shown in Figure 5. The average CO₂
144 concentration was 840 ppm with notable fluctuations (range: 720 ppm to 1010 ppm). The fluctuations
145 seemed to be driven by changing ventilation due to outdoor infiltration and occasional entry of
146 researchers to check and operate equipment.

147 The average indoor O₃ concentration was 12 ppb when the far-UVC lamps were off and 14 ppb
148 when the UV lamps were on. Average outdoor concentrations were 35 ppb and 26 ppb when the UV
149 lamps were off and on, respectively. Indoor O₃ was moderately to strongly correlated with outdoor O₃
150 concentrations (Figure 6) when the UV lamps were off ($\rho = 0.65$, $p = 2 \times 10^{-12}$) or on ($\rho = 0.74$, $p = 2 \times 10^{-29}$).
151 A linear regression model, adjusted for outdoor O₃ concentration, indicated that the usage of the UV
152 lamps increased the indoor O₃ concentration by 5.7 ppb (95% confidence interval (CI) 4.9 – 6.5 ppb). A 1-
153 ppb increase in outdoor O₃ was associated with a 0.33-ppb increase in indoor O₃ (95% CI 0.29 – 0.36).

154 3.3. UFP Concentrations

155 The total UFP concentration in the sealed room ranged from 87 #/cm³ to 6262 #/cm³ (UV off) and from
156 110 #/cm³ to 3884 #/cm³ (UV on) with peaks seemingly unrelated to operation of the far-UVC lamps
157 throughout the sampling period (see Figure 5). The total UFP concentration in the standard room ranged
158 from 167 #/cm³ to 2196 #/cm³ (UV off) and from 155 #/cm³ to 6012 #/cm³ (UV on) with major
159 fluctuations also seemingly unrelated to far-UVC usage throughout the sampling period.

160 UFP concentrations in the sealed room were, on average, lower and less variable than those in
161 the standard room. The concentrations in both rooms were higher during far-UVC usage compared to
162 times when the lights were off (Figure 7). Addition of filtration reduced the particle concentrations in
163 both rooms. Simultaneous measurements of UFP in paired rooms and outdoors were not available.

164 In the standard room, with the far-UVC lamps off, the filtration reduced the average UFP counts
165 from 1173 (95% CI 1023 – 1323) to 807 (95% CI 672 – 943). With the far-UVC lamps on, the filtration
166 reduced the average UFP counts from 2425 (95% CI 2219 – 2630) to 760 (95% CI 563 – 957).

167 In a simple linear model, without adjustment for indoor or outdoor O₃, UV in the standard room
168 was associated with an increase in UFP (1019, 95% CI 747 – 1290) and filtration was associated with a
169 decrease in UFP (-1276, 95% CI -1014 to -1537). Further analysis, however, indicated that the
170 relationship between total particle number concentrations, UV, and O₃ was complex. In the absence of

171 UV, when adjusted for outdoor O₃ and filtration, increasing indoor O₃ was associated with increasing UFP
172 concentrations (153 ppb⁻¹, p = 3x10⁻⁹). However, when far-UVC lamps were on and we adjusted for
173 outdoor O₃ and filtration, indoor O₃ was associated with decreasing UFP concentrations (-158 ppb⁻¹ p =
174 2x10⁻¹³). Thus, other factors related to ventilation seemed to have major impacts on UFP concentrations.

175 4. Discussion

176 4.1. O₃ concentrations

177 Our findings suggest that 222 nm far-UVC usage increases indoor O₃ concentrations above levels typically
178 found in buildings. For example, in the absence of indoor sources, indoor O₃ concentrations (in schools,
179 offices, and residences) are typically around 4-6 ppb³¹. In our study, average O₃ concentrations in the
180 standard hotel room were 12 ppb with UV off and 14 ppb with UV lamps on. When adjusted for outdoor
181 O₃, the increase of O₃ in the standard room during UV usage was estimated to be 5.7 ppb. This increase
182 is similar to the ~6.5-ppb increase recently reported by Peng et al. (2023)²⁶, who measured O₃ in a sealed
183 office room with and without 222 nm far-UVC lamp usage. All measured indoor O₃ concentrations in our
184 study and in Peng et al. (2023)²⁶ were well below the US ambient (EPA)³² and occupational (OSHA)³³ 8-
185 hour exposure limits (50-100 ppb), and WHO³⁴ 8-hour ambient air quality guideline levels (50 ppb). Long-
186 term exposure to ambient O₃ levels of 30-40 ppb or higher is associated with elevated health risks^{35,36}.
187 These levels far exceed the average indoor O₃ concentrations (with far-UVC lamps on) measured in our
188 study. However, the reader should note that there seems to be no clear threshold for adverse health
189 effects³⁷.

190 The sealed empty hotel room served as a baseline test room in our study, intended to examine
191 worst-case conditions with low air exchange, similar to the experimental conditions in recent
192 publications^{23, 26, 27}. Our O₃ concentration levels in the sealed room were similar to Peng et al. (2023)²⁶.

193 The modelled average fluence rates in this study were 1.7-1.8 μW/cm², which correspond to a
194 50-51 mJ/cm² dose during an 8-hr period (151-153 mJ/cm² during a 24-h period). These are below ACGIH
195 recommended 8-hr exposure limits (161 mJ/cm² for eyes and 479 mJ/cm² for skin)³⁸ but higher than the
196 ICNIRP 8-hr exposure limit³⁹ of 23 mJ/cm².

197 4.2. Ultra-fine particle concentrations

198 In our study, we saw elevated UFP concentrations during far-UVC lamp usage in both rooms.
199 However, linear regression models adjusted for outdoor O₃ levels indicated that when far-UVC lamps

200 were on, increasing indoor O₃ was associated with decreasing UFP concentrations in the standard hotel
201 room. This suggests that increases of UFP concentrations in the standard room were mainly influenced
202 by factors other than far-UVC generated O₃. Local combustion is one potential source of UFPs⁴⁰ that can
203 penetrate indoors (infiltration of outdoor particles). Although doors and windows were closed during our
204 measurements, indoor O₃ concentrations responded rapidly to outdoor O₃ changes, suggesting that
205 significant infiltration was occurring. Occasionally noticeable cooking odors, possibly originating from the
206 floor below, suggested presence of significant unmeasured indoor UFP sources. Nevertheless, in-room
207 HEPA filtration produced consistently low UFP concentrations with and without operation of far-UVC
208 lamps.

209 4.3. Limitations of the study

210 As this study was carried out in a real-world setting, it has limitations that should be considered when
211 assessing the results. One limitation is that we did not carry out local O₃ and UFP measurements directly
212 outside of the hotel and in the hallways outside of the rooms. Hence, we could not define to what extent
213 the O₃ or UFP concentration changes were driven by ambient conditions as opposed to far-UVC usage.
214 Also, because the measurements of the different cases (sealed/standard room, UV on/off, etc.) were
215 carried out in series, the data could not be paired. Also, because ambient conditions varied, comparing
216 different cases was not ideal.

217 We chose to calculate average concentrations (O₃, UFPs) based on all data in different cases (not
218 only during steady-state conditions) because measurements in real-world settings do not often have
219 steady-state conditions, as was clearly seen in the standard room measurements. This should be kept in
220 mind when interpreting our results, as they might differ from laboratory measurements where it is easier
221 to reach steady-state conditions and use them in the measurements and analysis.

222 Future studies in real-world settings could benefit from having a control room to monitor
223 different factors simultaneously and form paired data for more accurate assessment of the effect of
224 different factors on O₃ and UFP formation. It would also be beneficial to monitor O₃ and UFPs directly
225 outside of the space, since fluctuations in local concentrations might affect the measured values
226 substantially through infiltration.

227 5. Conclusions

228 222 nm far-UVC is a promising tool for mitigating aerosol spread of infections in high-risk settings, e.g.,
229 hotel quarantine facilities. However, recent studies have raised health concerns related to O₃ production
230 and secondary chemistry caused by the lamps. We found that 222 nm far-UVC lamps do increase O₃
231 concentrations indoors, but the average levels are lower than and notably influenced by outdoor
232 concentrations and remain well below EPA 8-hour ambient exposure limits. Additionally, we did not find
233 a clear relationship between UV usage and UFP concentrations. Despite study limitations, our results do
234 not suggest a major impact of far-UVC on indoor UFP concentrations in the real-world environment that
235 we examined. Nevertheless, we should be cognizant of and work to reduce the potential effects far-UVC
236 has on IAQ, especially in environments with low ventilation.

237 Acknowledgements

238 The authors would like to thank the Balvi Foundation for funding this study. Also, support from
239 NOAA/ARL, NIST, and MDE for trace gas measurements is gratefully acknowledged.

240 References

- 241 1. Adam, D. C. *et al.* Risk of within-hotel transmission of SARS-CoV-2 during on-arrival quarantine in
242 Hong Kong: an epidemiological and phylogenomic investigation. *The Lancet Regional Health –*
243 *Western Pacific* **0**, (2023).
- 244 2. Wei, H.-Y. *et al.* Probable Aerosol Transmission of SARS-CoV-2 through Floors and Walls of
245 Quarantine Hotel, Taiwan, 2021. *Emerg Infect Dis* **28**, (2022).
- 246 3. Gu, H. *et al.* Probable Transmission of SARS-CoV-2 Omicron Variant in Quarantine Hotel, Hong Kong,
247 China, November 2021. *Emerg Infect Dis* **28**, (2021).
- 248 4. Wong, S.-C. *et al.* Transmission of Omicron (B.1.1.529) - SARS-CoV-2 Variant of Concern in a
249 designated quarantine hotel for travelers: a challenge of elimination strategy of COVID-19. *The*
250 *Lancet Regional Health – Western Pacific* **18**, (2022).
- 251 5. Grout, L. *et al.* Failures of quarantine systems for preventing COVID-19 outbreaks in Australia and
252 New Zealand. *Medical Journal of Australia* **215**, 320–324 (2021).
- 253 6. Leong, L. E. X. *et al.* Whole-Genome Sequencing of SARS-CoV-2 from Quarantine Hotel Outbreak.
254 *Emerg Infect Dis* **27**, 2219–2221 (2021).

- 255 7. Hart, D. STERILIZATION OF THE AIR IN THE OPERATING ROOM BY SPECIAL BACTERICIDAL RADIANT
256 ENERGY: Results of Its Use in Extrapleural Thoracoplasties. *Journal of Thoracic Surgery* **6**, 45–81
257 (1936).
- 258 8. Wells, W. F. *et al.* The environmental control of epidemic contagion I. An epidemiologic study of
259 radiant disinfection of air in day schools. *Am J Hyg* **35**, 97–121 (1942).
- 260 9. Riley, R. L. and Permutt, S. Room air disinfection by ultraviolet irradiation of upper air. Air mixing and
261 germicidal effectiveness. *Arch Environ Health* **22**, 208–219 (1971).
- 262 10. Bergman, R. *et al.* Air Disinfection with Germicidal Ultraviolet: For this Pandemic and the Next.
263 *Photochem Photobiol* **97**, 464–465 (2021).
- 264 11. Reed, N. G. The history of ultraviolet germicidal irradiation for air disinfection. Public Health Rep.
265 125 (1), 15-27 (2010). ISSN 0033-3549.
- 266 12. Wells, W. F. and Wells, M. W. Measurement of Sanitary Ventilation. *Am J Public Health Nations*
267 *Health* **28 (3)**, 343-350 (1938). doi: 10.2105/ajph.28.3.343
- 268 13. Riley, R. L. and Permutt, S. Room air disinfection by ultraviolet irradiation of upper air. Air mixing and
269 germicidal effectiveness. *Arch Environ Health* **22 (2)**, 208-219 (1971). doi:
270 10.1080/00039896.1971.10665834
- 271 14. Riley, R. L. and Nardell, E. A. Clearing the air. The theory and application of ultraviolet air
272 disinfection. *Am Rev Respir Dis.* **139 (5)**, 1286-1294 (1989). doi: 10.1164/ajrccm/139.5.1286
- 273 15. Pfeifer, G.P. *et al.* Mutations induced by ultraviolet light. *Mutat Res.* **571(1-2)**, 19–31 (2005). doi:
274 10.1016/j.mrfmmm.2004.06.057.
- 275 16. Delic, N. C. *et al.* Damaging Effects of Ultraviolet Radiation on the Cornea. *Photochem Photobiol.*
276 **93(4)**, 920–929 (2017). doi: 10.1111/php.12686.
- 277 17. Eadie, E. *et al.* Extreme Exposure to Filtered Far-UVC: A Case Study†. *Photochem Photobiol* **97**, 527–
278 531 (2021).
- 279 18. Fukui, T. *et al.* Exploratory clinical trial on the safety and bactericidal effect of 222-nm ultraviolet C
280 irradiation in healthy humans. *PLOS ONE* **15**, e0235948 (2020).
- 281 19. Eadie, E. *et al.* Far-UVC (222 nm) efficiently inactivates an airborne pathogen in a room-sized
282 chamber. *Sci Rep* **12**, 4373 (2022).
- 283 20. Ma, B. *et al.* UV Inactivation of SARS-CoV-2 across the UVC Spectrum: KrCl* Excimer, Mercury-Vapor,
284 and Light-Emitting-Diode (LED) Sources. *Appl Environ Microbiol* **87**, e0153221 (2021).
- 285 21. Ma, B. *et al.* UV Inactivation of Common Pathogens and Surrogates Under 222 nm Irradiation from
286 KrCl* Excimer Lamps. *Photochemistry and Photobiology* **99(3)**, 975-982, (2023).

- 287 22. Welch, D. *et al.* Inactivation Rates for Airborne Human Coronavirus by Low Doses of 222 nm Far-UVC
288 Radiation. *Viruses* **14**, 684 (2022).
- 289 23. Barber, V. *et al.* Indoor Air Quality Implications of Germicidal 222 nm Light. Preprint at
290 <https://doi.org/10.26434/chemrxiv-2023-ft1l8> (2023).
- 291 24. Ma, B. *et al.* Reflection of UVC wavelengths from common materials during surface UV disinfection:
292 Assessment of human UV exposure and ozone generation. *Science of The Total Environment*, (2023)
293 doi:10.1016/j.scitotenv.2023.161848.
- 294 25. Peng, Z. *et al.* Model Evaluation of Secondary Chemistry due to Disinfection of Indoor Air with
295 Germicidal Ultraviolet Lamps. *Environ. Sci. Technol. Lett.* (2022) doi:10.1021/acs.estlett.2c00599.
- 296 26. Peng, Z. *et al.* Significant Production of Ozone from Germicidal UV Lights at 222 nm. *Environ. Sci.*
297 *Technol. Lett.* (2023), **10**, 668-674.
- 298 27. Link, M. F. *et al.* Ozone generation from a Germicidal Ultraviolet lamp with Peak Emission at 222 nm.
299 *Environ. Sci. Technol. Lett.* (2023), **10**, 675-679.
- 300 28. Centers for Disease Control, National Center for Immunization and Respiratory Diseases (NCIRD),
301 Division of Viral Diseases. Community, Work, and School: Ventilation in Buildings. *Centers for*
302 *Disease Control and Prevention* [https://www.cdc.gov/coronavirus/2019-](https://www.cdc.gov/coronavirus/2019-ncov/community/ventilation.html)
303 [ncov/community/ventilation.html](https://www.cdc.gov/coronavirus/2019-ncov/community/ventilation.html) (2023).
- 304 29. Batterman, S. Review and Extension of CO₂-Based Methods to Determine Ventilation Rates with
305 Application to School Classrooms. *Int J Environ Res Public Health* **14**, 145 (2017).
- 306 30. Zhu, S. *et al.* Ventilation and laboratory confirmed acute respiratory infection (ARI) rates in college
307 residence halls in College Park, Maryland. *Environ Int* **137**, 105537 (2020).
- 308 31. Nazaroff, W. W. and Weschler C. J. Indoor Ozone: Concentrations and influencing factors. *Indoor Air*
309 **32 (1)**, e12942.
- 310 32. Environment Protection Agency (EPA) National Ambient Air Quality Standards (80 FR 65292).
311 Environmental Protection Agency (2015).
- 312 33. OSHA Occupational Safety and Health Standards 1910, Toxic and Hazardous Substances 1910
313 subpart Z, Air contaminants 1910.1000. Occupational Safety and Health Administration, Department
314 of Labor. Washington, DC, USA.
- 315 34. WHO global air quality guidelines. Particulate matter (PM_{2.5} and PM₁₀), ozone, nitrogen dioxide,
316 sulfur dioxide and carbon monoxide. Geneva: World Health Organization; 2021. Licence: CC BY-NC-
317 SA 3.0 IGO.
- 318 35. Jerret, M. *et al.* Long-Term Ozone Exposure and Mortality. *N Engl J Med* **360**, 1085-1095 (2009).

- 319 36. Lim, C. C. *et al.* Long-Term Exposure to Ozone and Cause-Specific Mortality Risk in the United States.
320 Am. J. Respir. Crit. Care Med **200 (8)**, 1022-1031 (2019).
- 321 37. Bell, M. L. *et al.* The exposure-response curve for ozone and risk of mortality and the adequacy of
322 current ozone regulations. Environ Health Perspect. **114**, 532-536 (2006).
- 323 38. American Conference of Governmental Industrial Hygienists (ACGIH) Threshold Limit Values and
324 Biological Exposure Indices. ACGIH; Cincinnati: 2022.
- 325 39. International Commission on Non-Ionizing Radiation Protection (ICNIRP). Guidelines on limits of
326 exposure to ultraviolet radiation of wavelengths between 180 nm and 400 nm (incoherent optical
327 radiation). *Health Physics*, **87 (2)**, 171-186 (2004).
- 328 40. Morawska, L. *et al.* Ambient nano and ultrafine particles from motor vehicle emissions:
329 characteristics, ambient processing and implications on human exposure. Atmos. Environ. **42**, 8113–
330 8138 (2008).
- 331
- 332

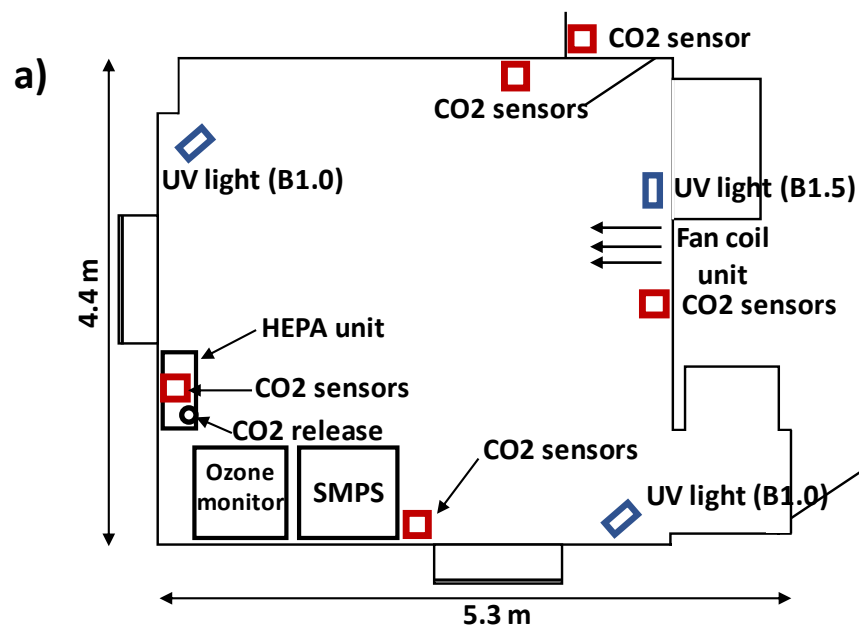

b)

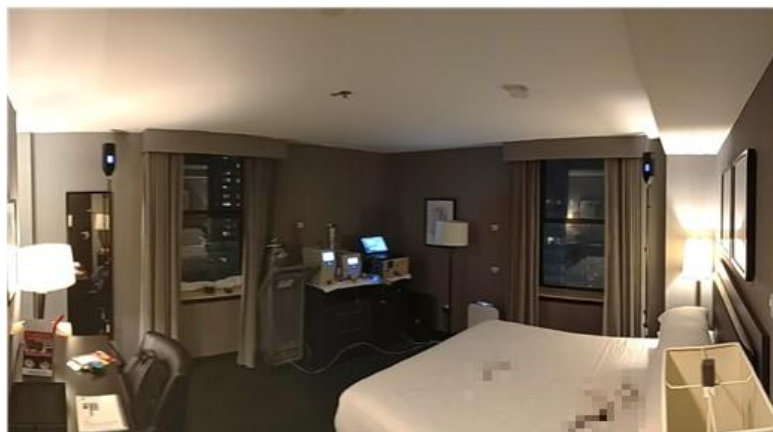

339

340 Figure 2. Standard hotel room. a) Floor plan (room height: 2.4 m) and position of far-UVC lamps and
341 sampling equipment. b) Photograph showing far-UVC lamps, sampling equipment, and standard
342 furnishing. Floor plan not in scale.

343

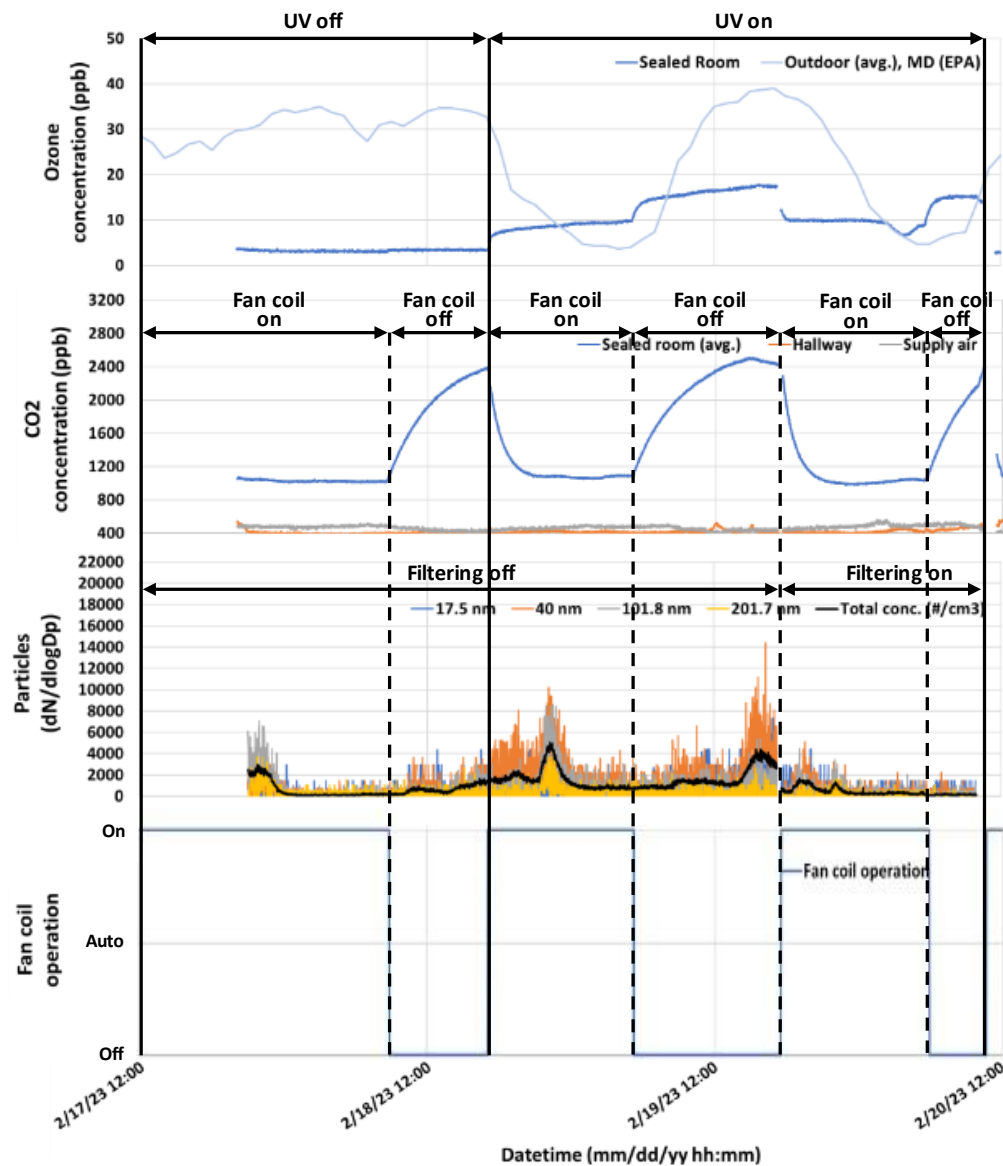

344
345 Figure 3. Sealed room O₃, CO₂ and ultra-fine particle measurements plotted against time. Periods with
346 far-UVC lamps (on/off), in-room HEPA filtering (on/off) and fan coil unit states (on/off/auto) are shown.
347 Fan coil unit had 2 states: off (0.1 ACH) and on (0.5 ACH). During the filtering periods the fan coil unit had
348 a MERV 13 filter and the HEPA filter unit had a HEPA filter but they had no filter during other times. The
349 outdoor O₃ levels are an average of three Maryland sites (Essex, Glen Burnie, Padonia) in the EPA
350 Ambient Air Monitoring Network. The CO₂ concentration in the sealed room is an average of all sensors
351 in the room.
352

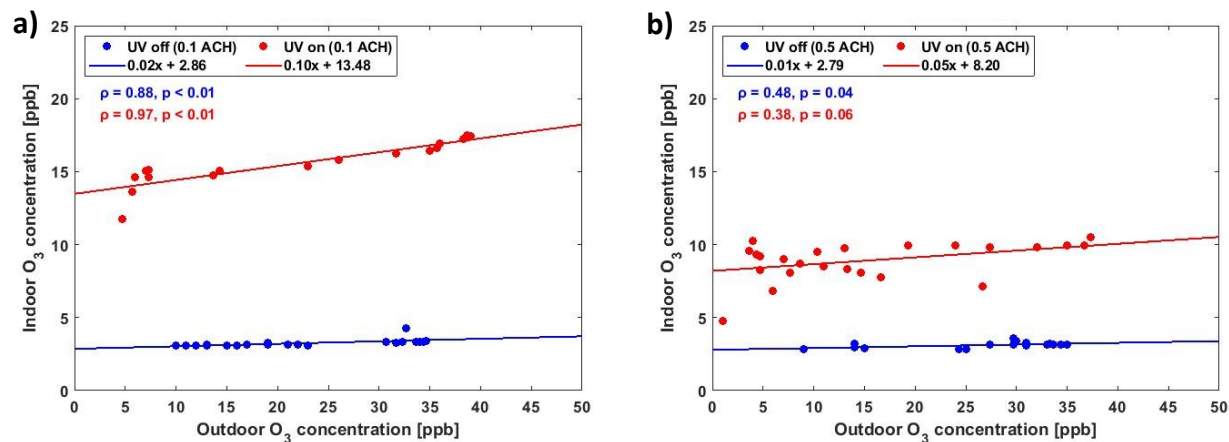

353

354 Figure 4. Sealed room indoor-outdoor concentration correlations with and without UV with (a) 0.1 ACH
355 (fan coil off) and (b) 0.5 ACH (fan coil on) ventilation rates. The outdoor O₃ levels are an average of three
356 Maryland sites (Essex, Glen Burnie, Padonia) in the EPA Ambient Air Monitoring Network. ρ is the
357 Spearman's rank correlation coefficient.

358

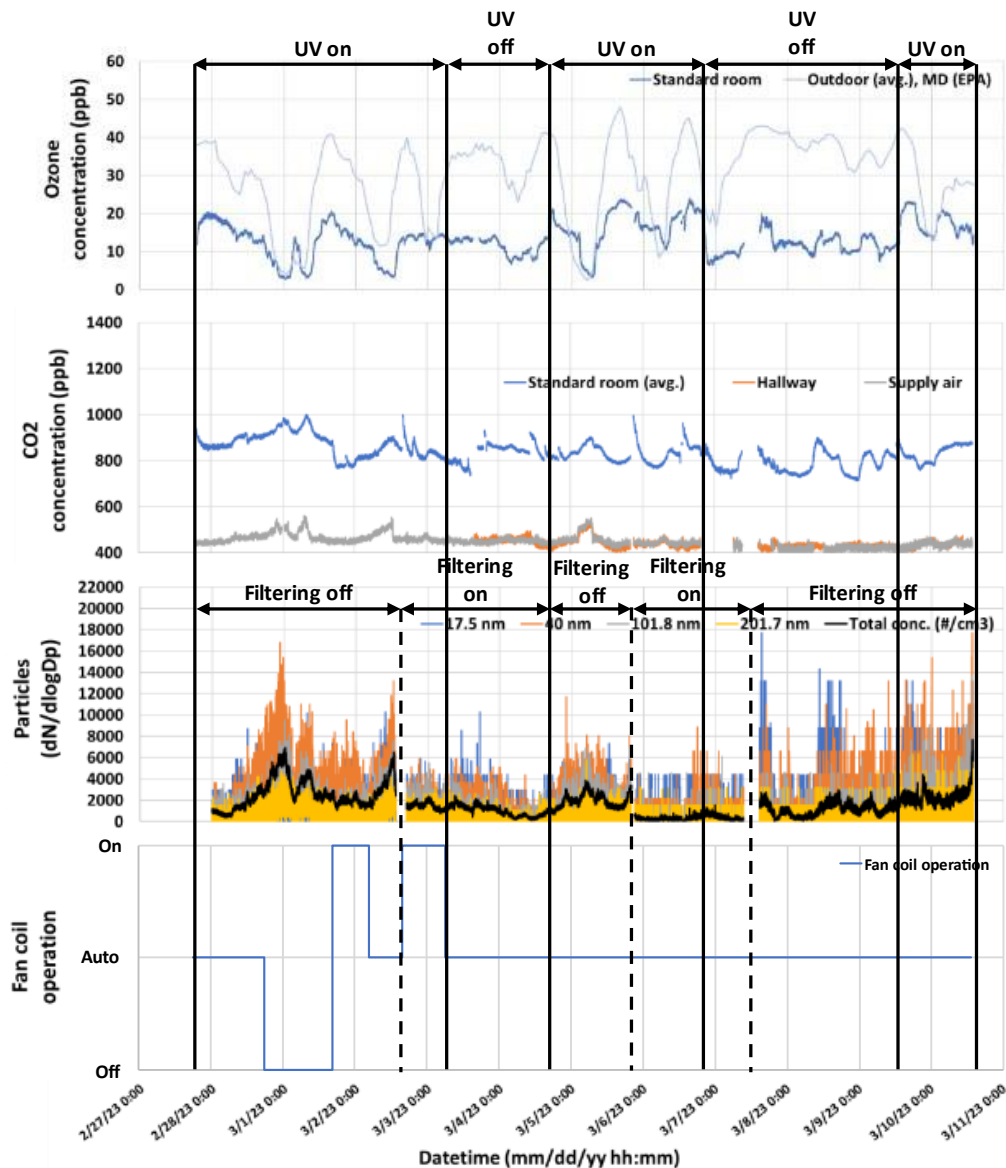

359
360 Figure 5. Standard hotel room O₃, CO₂, and UFP measurements from February 27 through March 11,
361 2023. Periods with far-UVC lamps and in-room HEPA filtering on and off and fan coil unit states (on, off
362 and auto) are shown. During the auto state, the fan coil unit ran intermittently as controlled by a
363 thermostat and motion sensor. During the filtering periods the fan coil unit had a MERV 13 filter and the
364 HEPA filter unit had a HEPA filter but they had no filter during other times.
365

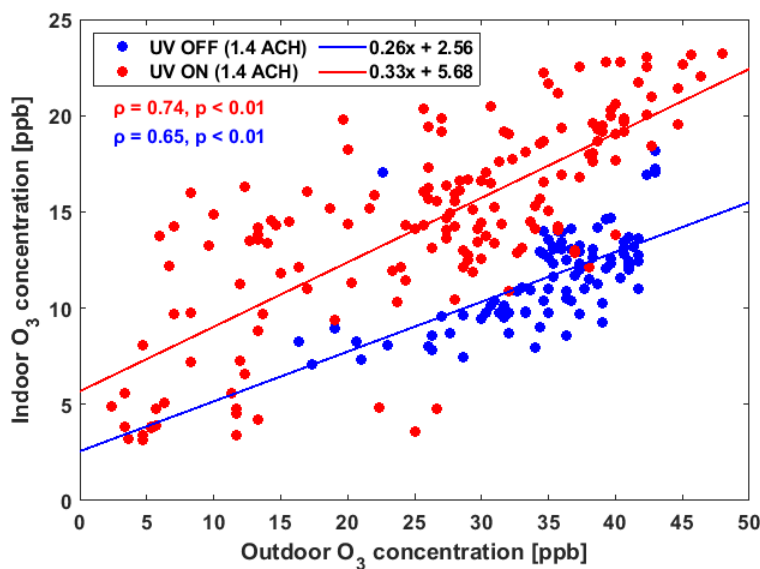

366
367 Figure 6. Indoor versus outdoor O₃ concentrations for the standard hotel room when far-UVC lamps were
368 on and off (with an average air exchange rate of 1.4 ACH). The outdoor O₃ levels are an average of three
369 Maryland sites (Essex, Glen Burnie, Padonia) in the EPA Ambient Air Monitoring Network. ρ is the
370 Spearman's rank correlation coefficient.
371

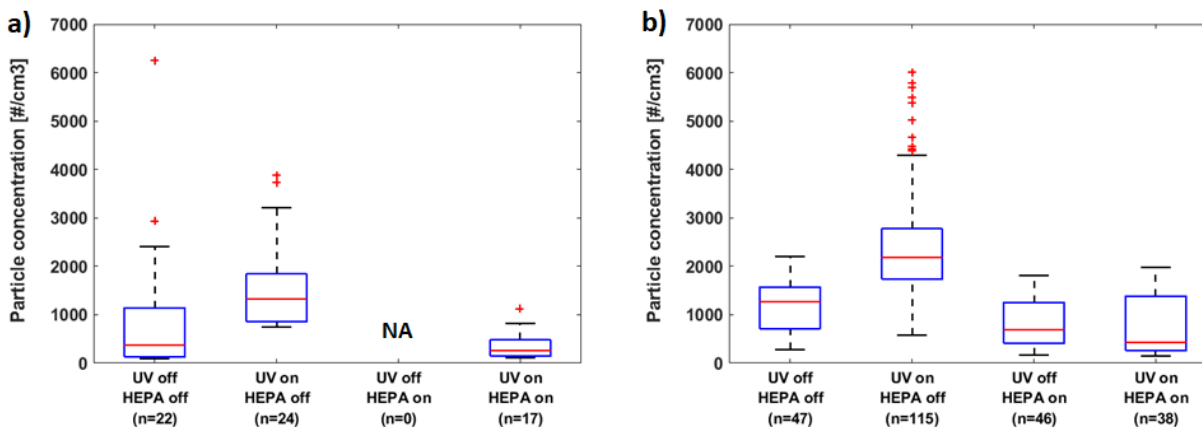

372

373 Figure 7. Ultra-fine particle concentrations (17.5 to 289 nm) with and without use of 222 nm far-UVC
374 lamps and HEPA filters a) in the sealed unfurnished room (no data from HEPA on UV off) and b) in the
375 standard room. Boxplots show medians (redline inside the boxes), 25th and 75th percentiles (top and
376 bottom of the boxes), most extreme data not considered outliers (whiskers) and outliers (red crosses) of
377 1-hr data. n represents the number of 1-hr data points included in each boxplot. HEPA filter units
378 delivered 232 L/s (9.1 ACH) in the sealed room and 116 L/s (7.1 ACH) in the standard room. Simultaneous
379 background measurements to account for indoor and outdoor sources were not collected.

380