

***In vitro* potency of combinatorial antifungal drugs towards *Candida* isolates from patients.**

Sakshi Agarwal¹, Smitanjali Parida¹, Bhuvnesvri Jadoun¹, Shreya N Patel¹, Sumit Moolchandani¹, Himanshu Puniyani¹, Raviranjan Kumar Pandey¹, Mandvi Mathur², Sandeep K Shrivastava^{1, 2}, Aakanksha Kalra^{1*}

1 – Dr. B. Lal Institute of Biotechnology (BIBT), Jaipur, Rajasthan, India

2 – Centre for Innovation, Research and Development (CIRD), Dr. B. Lal Clinical Laboratory Pvt. Ltd., Jaipur, Rajasthan, India

*Corresponding Author – aakankshakalra.07@gmail.com

Correspondence address: Dr. B. Lal Institute of Biotechnology, 6E, Malviya Industrial Area, Jaipur, Rajasthan, India.

Contact details: +91-9650689632

Fax: 2752241

Acknowledgments: The authors acknowledge the Intramural Research Scientific Committee, Dr. B. Lal Institute of Biotechnology, Jaipur for funding the research.

Abstract

Candidiasis is a fungal infection (mycosis) caused by an opportunistic yeast with only 8-10 pathogenic species. In spite of the multiple classes of antifungal drugs available to combat these infections, the treatment is hampered by drug toxicity, tolerability, emergence of drug resistant isolates and many more. Combination therapy has been suggested as a possible approach to improve these treatment outcomes. This study is, therefore, aimed at the analysis of the sensitivity of *Candida* isolates obtained from patients towards different classes of drugs affecting multiple pathways in the pathogen life cycle. Four different individual drugs with different mechanisms of action and six different combinations of these drugs at three different proportions (1:1, 1:3, and 3:1) were used for the study. All the drug sensitivity assays were performed by the agar well diffusion method. The results were statistically analyzed using Prism software. Results have shown synergistic effects of drug combinations on the sensitivity of the isolates without much variation in the stoichiometric ratios, thereby providing an alternative to monotherapy to combat the emergence of drug resistant isolates and drying existing drug pipelines.

Keywords: Candidiasis, *Candida*, Isolates, Drug combinations, Statistical analysis

1. Introduction:

The last few years have witnessed progressive increase in mycotic infections which are one of the primary causes of morbidity and mortality especially in immunocompromised and severely ill patients. *Candida* is a fungal pathogen which is usually a member of normal flora but transits to pathogenic form by several virulence factors like adherence to host tissues and medical devices, secretion of extracellular hydrolytic enzymes etc. (Deorukhkar *et al.*, 2014). The species is responsible for various clinical manifestations including overgrowth as well as life threatening disseminated infections. *Candida* species have been reported as the fourth most common nosocomial bloodstream pathogen by National Nosocomial Infections Surveillance System (NNISS) with a mortality rate of about 45% (Deorukhkar *et al.*, 2014). Till date, more than 150 species of *Candida* are known with only 10 species responsible for the disease with *C. albicans* being responsible for majority of the infections. However, recent studies have shown the increase in incidences of infection due to non-albicans *Candida* species like *Candida auris*, *Candida tropicalis*, *Candida glabrata*, *Candida parapsilosis*, *Candida krusei* and *Candida lusitanae*

(Abi-Said et al., 1997; Da Costa et al., 2009). The fatality of fungal infections in immune-compromised conditions has been recently observed with mucormycosis (black fungus) and *Candida* (white fungus) infections (Soni et al., 2021). These infections spread worldwide in both COVID-19 positive patients as well as patients recovered from COVID-19. Studies have shown the presence of oropharyngeal Candidiasis in patients suffering from COVID-19 (Salehi et al., 2020) and *C. auris* infections in critically ill COVID-19 patients (Chowdhary et al., 2020).

Several non-albicans species are inherently resistant or acquire resistance to commonly used antifungal drugs. Factors like severe immunosuppression, prematurity, use of broad-spectrum antibiotics, and usage of antimycotic drugs are associated with this change (Deorukhkar et al., 2014). Six different classes of antifungal drugs with different modes of action are available which selectively eliminate fungal pathogens from a host with minimal toxicity to the host. These include Azoles, Allylamines, Polyenes, Echinocandins, Nucleotide Analogue and Penicillin derivatives. Amphotericin and Azoles have been the choice of drugs for patients suffering from mucormycosis and *Candida* infections during the COVID-19 outbreak (Song et al., 2020). However, numerous recent studies have shown the emergence of drug resistant *Candida* strains and isolates. This along with increase in disease causing species has led to a dire need for development of newer drug strategies. One of these novel drug strategies is the combinatorial therapy consisting of multiple drugs affecting different pathways which have proven to be much more efficacious than a single counterpart. It offers numerous advantages such as no or very less toxicity analysis, lower treatment failure rate, lower case-fatality ratios, fewer side-effects than monotherapy, slower development of resistance, and thus less money needed for the development of new drugs (Cuenca-Estrella, 2004). Thus, in view of this, the present study is focused on determining the drug sensitivity profiles of *Candida* isolates obtained from patients in Rajasthan, India. Further, we have also analyzed the efficacy of drug combinations of multiple drugs in three different stoichiometric ratios towards these isolates. All the results were appropriately statistically analyzed. Our results have clearly shown that all drug combinations are much more efficacious than a single drug towards these isolates without much variation observed at different stoichiometric ratios.

2. Materials and Methods:

2.1 *Candida* isolates and culture conditions:

Candida isolates used in the study were kindly provided by MCRD-CIRD (Microbial Culture Repository Division – Centre for Innovation, Research & Department), Dr. B. Lal Clinical Laboratory Pvt. Ltd., Jaipur. These isolates were extracted from various infectious human samples such as urine, blood, pus and vaginal swabs obtained from Candidiasis patients in Rajasthan. Patient's demographic details such as sex, age and clinical information were recorded and used for analysis. The study consists of a total of 17 isolates which were cultivated and maintained on YEPD medium (Hi Media Laboratories, Mumbai, India) (unless specified) at 30°C. The isolates were confirmed macroscopically by visualizing the colony morphology (creamy colony in color) on YEPD agar plates as well as microscopically using Indian ink (Nigrosin) staining.

2.2 Preparation of Antifungal drugs and drug combinations:

A total of four drugs, Itraconazole, Amphotericin B, Micafungin and Terbinafine, belonging to different classes were used in the study. All the drugs were prepared in DMSO as per CLSI guidelines. Itraconazole and Amphotericin B were used at a concentration of 13.5 mg/ml and 0.33 mg/ml while Micafungin and Terbinafine were used at a concentration of 0.33 mg/ml and 0.435 mg/ml. DMSO was used as a negative control for all the assays.



Depending on the results obtained from drug sensitivity assays using individual drugs, a total of six drug combinations were prepared at three different stoichiometric assays. The drug combinations used for the study are shown in Figure 1.

2.4 Antifungal drug sensitivity:

All the drug sensitivity assays were performed as per standard procedures in accordance with NCCLS guidelines by agar well diffusion assay. Briefly, the isolates were primarily inoculated in Sabouraud Dextrose Broth (SDB) and incubated at 30°C for 24 hrs. These grown cultures were then diluted to an O.D. of 0.2 and then swabbed on SDA plates. Wells were punctured in these plates and 50µL of the prepared drug/drug combination was added into wells. Wells containing DMSO were used as negative control. Plates were incubated for 24 hrs at 30°C and the clear zone obtained around the well, known as the zone of inhibition (ZOI), was measured by zone measuring scale.

2.5 Statistical analysis:

The mean ZOI ± standard deviation of all isolates for a drug or a drug combination was calculated and was used for the comparison of the significance of drug combinations to individual drugs as well as combinations at various proportions. All the statistical analysis was done by unpaired t test using PRISM version 5.0.

3. Results and discussions:

3.1 Demographic analysis of the isolates:

Demographic analysis of the isolates was done on the basis of gender, age group, sample type as well as species causing the infections (Figure 2). The details of the isolates obtained are summarized in the supporting data (Table S1). As it is evident from the results, *Candida* infections are not gender biased and affect both males and females (Figure 2a). However, previous studies have shown that females are slightly more prone to *Candida* infections owing to their higher susceptibility towards UTIs (Urinary Tract Infections) (*Behzadi et al., 2015; Dan et al., 2002*). The deviation in our results from the previous studies could be attributed to the smaller number of isolates used in the study (*Loster et al., 2016; Strati et al., 2016*). The analysis of these infections in different age groups suggested almost similar infectivity rate in all age groups with slight increased rates in older age groups owing to weaker immune systems (Figure 2b). This is well in agreement with previous studies suggesting that *Candida* infections mostly occur in immunocompromised patients, so it can occur in any age group who have weaker immune response (*Flevvari et al., 2013; Barchiesi et al., 2017; Alrayyes et al., 2019; Laupland et al., 2005*).

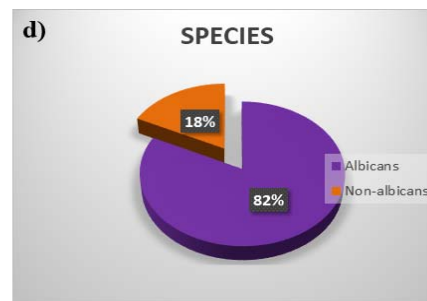
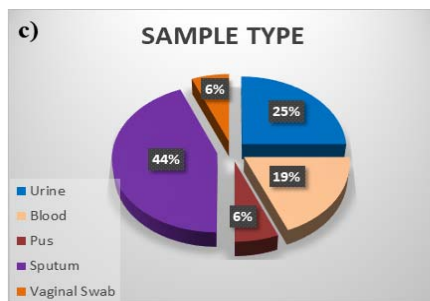
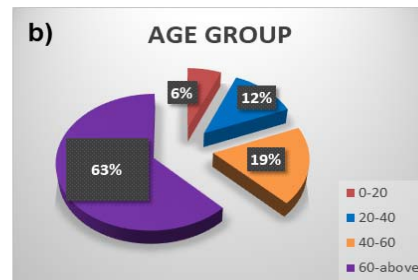
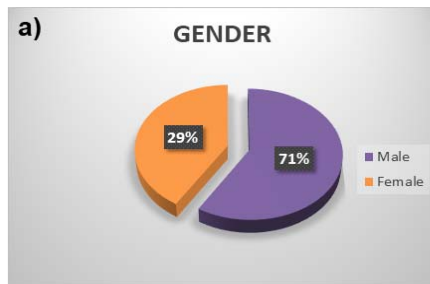

Our results showed that majority of samples were obtained from the patient's sputum and urine, indicating that *Candida* majorly affects respiratory and urinary systems in the human body (Figure 2c). It can also be correlated from previous studies suggesting that the organism majorly affects lungs causing diseases like pneumonitis (*Pendleton et al., 2017; Huffnagle et al., 2018*). Besides, *Candida* based UTI infections are also very prevalent mostly observed in females as vaginal candidiasis, vulvovaginal candidiasis caused by *Candida albicans* (*Behzadi et al., 2015; Rodriguez et al., 2020; Tortelli et al., 2020; Achkar et al., 2010*). Isolates obtained from blood demonstrate the severity of the disease (Figure 2c). Evidences have also suggest the occurrence of *Candida* pneumonia and Candiduria in severely immunocompromised individuals with disseminated disease (*Dermawan et al., 2018; Harris et al., 1999*). Although the emergence of infections caused by non-albican species is increasing, the majority of the infections in this study were caused by albican species only (Figure 2d). This albican species bias has been observed previously as well from a number of studies (*Kim et al., 2011; Babic et al., 2010; Makeinen et al., 2018*). However, infections caused by non-albican species such as *auris, glabrata*, etc. are rising continuously which are also causing an increase in emergence of drug resistance (*Bhattacharjee, 2016; Crabtree & Prather, 1933; Glöckner & Cornely, 2015; Deorukhkar et al., 2014; Fu et al., 2017*).

3.2 Drug sensitivity of isolates towards monotherapeutic drugs:

Four different antifungal drugs belonging to different classes were used for the study. Drug sensitivity analysis by standard well diffusion assay was done with DMSO as the negative control. Representative images of drug sensitivity assay are shown in the supporting data (Figure S2) and as per CLSI guidelines 17mm ZOI was taken as the cut-off value. On the basis of results shown in Table 1, it is clear that all the isolates were sensitive to Amphotericin B and Micafungin while only 59% and 53% isolates were sensitive to Terbinafine and Itraconazole respectively. The sensitivity of the isolates towards Amphotericin B and Micafungin have also been previously reported to 99.5% and 100% respectively (*Bitew & Abebaw, 2018; Santhanam et al., 2013*).

S.No.	Sample	Amphotericin	Terbinafine	Itraconazole	Micafungin
1	RPC 804	21 mm	14mm	14mm	17mm
2	C1654	20 mm	12mm	10mm	19mm
3	37/1561	21 mm	13mm	14mm	21mm
4	RPC 937	20 mm	16mm	16mm	23mm
5	64/316	22 mm	0mm	10mm	19mm
6	20/519	19 mm	14mm	17mm	21mm
7	MNC 2175	26 mm	26mm	20mm	21mm
8	KNC 32	21mm	23mm	0mm	29mm
9	C1805	20mm	16mm	10mm	17mm
10	330/1994	23mm	24mm	31mm	28mm
11	C2325	26mm	22mm	18mm	27mm
12	C2262	27mm	25mm	18mm	26mm
13	C2264	26mm	25mm	19mm	29mm
14	C2321	25mm	21mm	20mm	30mm
15	C386	24mm	25mm	20mm	29mm
16	C128	21mm	26mm	21mm	30mm
17	C2554	25mm	30mm	18mm	32mm
	Percent Sensitivity	100 (17/17)	59 (10/17)	53 (10/17)	100 (17/17)

Similar results were observed with patients suffering from oral Candidiasis or autoimmune *Candida* dystrophy (Rautemaa et al., 2008). Similarly, emerging resistance was observed for *Candida* isolates towards Itraconazole (Santhanam et al., 2013; Rautemaa et al., 2008; Darma et al., 2020). Also, emergence of resistant has been observed with isolates towards Terbinafine (Jensen et al., 2015), in patients suffering from Balanoposthitis caused by *Candida albicans* (Hu

et al., 2016). These results along with previous studies clearly indicate the emergence of drug resistant isolates in the area under the study and elsewhere towards Azoles & Terbinafine. Thus, alternate options need to be evaluated to combat the infections caused by the pathogen.

3.3 Drug sensitivity of isolates towards combinatorial therapy:

Studies so far have indicated that individual drugs may not be the best choice in the current scenario. Multiple studies have illustrated drug combinations to be more efficacious preventing the emergence of resistant strains, lowering the concentration of drugs and treating critically ill patients rapidly (*Ahmed et al.*, 2014). Not just towards *Candida* infections, combinatorial drugs have proven to be effective in other infections as well such as *Chaetomium* species (*Sun et al.*, 2019), invasive aspergillosis (*Martin-Pena et al.*, 2014), invasive mold diseases in hematologic patients (*Candoni et al.*, 2015). We, therefore, have analyzed the drug sensitivity of isolates towards drug combinations at three different stoichiometric ratios. The drugs to which more than and less than 60% isolates were sensitive were considered as S and R respectively. Representative images of drug sensitivity assay are shown in the supporting data (Figure S3). The drug combinations were used to evaluate the synergistic effects of drugs in combinations. On the basis of results shown in Table 2, 3 and 4, Itraconazole and Terbinafine were individually not effective to all the isolates but their combination was especially effective when used at 1:1 combination. Similarly, all the other five combinations showed statistically significant synergistic effects towards the growth of the isolates.

S.No.	Sample	Zone of inhibition					
		I+T	M+T	A+T	I+M	A+I	A+M
1	RPC 804	25 mm	30mm	28mm	28mm	25mm	29mm
2	C1654	23 mm	29mm	18mm	27mm	20 mm	28mm
3	37/1561	25 mm	28mm	22mm	29mm	21 mm	24mm
4	RPC 937	27 mm	31mm	21mm	27mm	24mm	25mm
5	64/316	26 mm	28mm	19mm	26mm	23mm	26mm
6	20/519	40 mm	40mm	35mm	0mm	31mm	24mm
7	MNC 2175	31 mm	27mm	23mm	28mm	20mm	28mm
8	KNC 32	26 mm	32mm	18mm	26mm	30mm	25mm
9	C1805	28 mm	28mm	24mm	27mm	26mm	25mm
10	330/1994	25 mm	30mm	23mm	27mm	28mm	30mm
11	C2325	32 mm	32mm	20mm	31mm	23mm	29mm
12	C2262	27 mm	30mm	21mm	28mm	24mm	26mm
13	C2264	27 mm	33mm	20mm	32mm	24mm	28mm
14	C2321	28 mm	31mm	24mm	27mm	22mm	27mm
15	C386	34 mm	32mm	19mm	33mm	23mm	27mm
16	C128	30 mm	32mm	20mm	27mm	25mm	26mm
17	C2554	32 mm	30mm	22mm	32mm	29mm	33mm

S.No.	Sample	Zone of inhibition					
		I+T	M+T	A+T	I+M	A+I	A+M
1	RPC 804	24 mm	32mm	25mm	24mm	24mm	29mm
2	C1654	24 mm	30mm	17mm	27mm	24mm	28mm
3	37/1561	25 mm	34mm	17mm	26mm	24mm	30mm
4	RPC 937	27 mm	32mm	23mm	27mm	16mm	30mm
5	64/316	26 mm	30mm	23mm	28mm	17mm	30mm
6	20/519	40 mm	40mm	39mm	31mm	27mm	32mm
7	MNC 2175	30 mm	36mm	26mm	29mm	20mm	31mm
8	KNC 32	29 mm	36mm	23mm	30mm	24mm	31mm
9	C1805	30 mm	32mm	22mm	28mm	23mm	31mm
10	330/1994	16 mm	18mm	30mm	11mm	28mm	31mm
11	C2325	40 mm	36mm	30mm	30mm	27mm	31mm
12	C2262	28 mm	30mm	24mm	24mm	25mm	27mm
13	C2264	27 mm	29mm	25mm	24mm	26mm	31mm
14	C2321	29 mm	32mm	23mm	28mm	26mm	28mm
15	C386	33 mm	30mm	26mm	24mm	27mm	28mm
16	C128	32 mm	32mm	23mm	24mm	18mm	28mm
17	C2554	34 mm	31mm	27mm	26mm	27mm	28mm

S.No.	Sample	Zone of inhibition					
		I+T	M+T	A+T	I+M	A+I	A+M
1	RPC 804	22 mm	32mm	24mm	22mm	23mm	25mm
2	C1654	21 mm	34mm	16mm	23mm	20mm	19mm
3	37/1561	24 mm	34mm	18mm	24mm	20mm	22mm
4	RPC 937	27 mm	34mm	20mm	22mm	18mm	20mm
5	64/316	27 mm	34mm	19mm	22mm	19mm	19mm
6	20/519	40 mm	40mm	32mm	32mm	29mm	29mm
7	MNC 2175	29 mm	33mm	25mm	26mm	20mm	27mm
8	KNC 32	27 mm	35mm	22mm	27mm	22mm	24mm
9	C1805	28 mm	31mm	20mm	26mm	25mm	21mm
10	330/1994	14 mm	16mm	30mm	12mm	26mm	34mm
11	C2325	30 mm	35mm	29mm	28mm	29mm	28mm
12	C2262	28 mm	32mm	22mm	27mm	22mm	24mm
13	C2264	30 mm	31mm	21mm	28mm	23mm	25mm
14	C2321	30 mm	32mm	27mm	30mm	25mm	24mm
15	C386	30 mm	32mm	23mm	29mm	24mm	24mm
16	C128	31 mm	34mm	23mm	27mm	19mm	22mm
17	C2554	32 mm	34mm	23mm	27mm	21mm	26mm

These results are well in agreement with numerous previous studies which have been discussed here. Studies have shown the active and synergistic interaction of azoles with Terbinafine, Amphotericin, and Echinocandins (micafungin) against *Candida* isolates (*Barchiesi et al., 1997; Odds, 1982; Roling et al., 2002; Sugar et al., 1995*). Another study has reported that a combination of Terbinafine and azole resulted in a fungicidal action against *C. albicans*, although the drugs were fungistatic when they were used individually (*Ghannoum & Elewski, 1999*). Studies have also shown simultaneous inhibition of different fungal cell targets, giving synergism between Echinocandins (cell wall active) and Amphotericin. Antifungal drug combinations have also been used against planktonic and sessile cells of *Candida albicans* (*Touil et al., 2018*). The combinations showed a higher cure rate, fewer relapses, and less nephrotoxicity than monotherapy with Amphotericin (*Johnson et al., 2004*). Similarly, Terbinafine has also shown synergistic effects due to their mechanism of actions, when used in combination with different drugs like azoles against *Candida albicans* & *Candida glabrata* infections (*Perea et al., 2002; Hay, 1999*). Thus, it can be concluded that combination therapy could provide an effective alternative to monotherapy for patients with invasive infections that are difficult to treat due to multi-resistant species.

3.4 Statistical analysis of combinatorial drugs at different proportions v/s monotherapy:

All the results obtained from drug sensitivity analysis were statistically analyzed as described in materials and methods using Prism version 5.0. The drug combinations were compared to the efficacy by individual drugs along with the three stoichiometric ratios of a combination. Mean \pm Std. Dev. of all the combinations and individual drugs are shown in Figure 3. For all the combinations, it was observed that the combinations were much better than monotherapy; however, no significant difference was observed between stoichiometric ratios except in the case of A + T and A + M combinations.

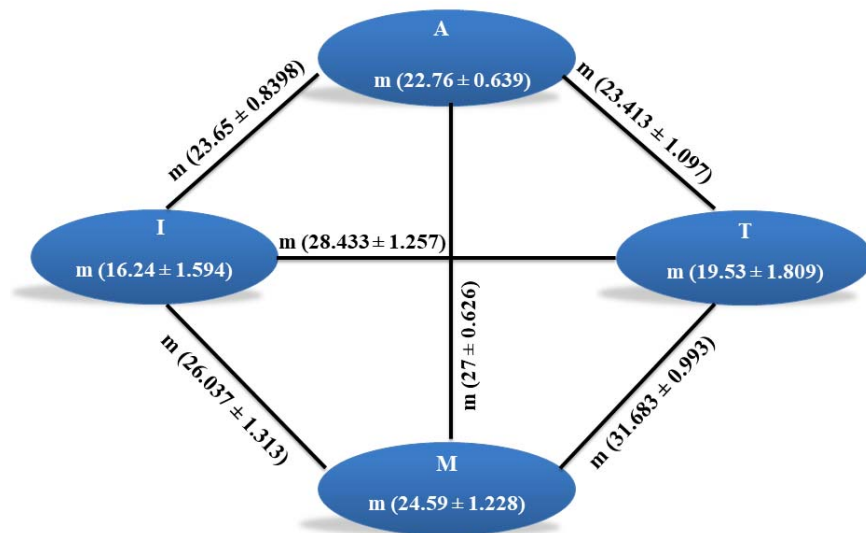

In the A+T combination, the mean was significantly different in 1:3 proportion while insignificant in other proportions as well as to individual drugs. In the A+M combination, the mean for 1:1 and 1:3 was significantly different from the individual drug, and when used in the combination of 3:1, no difference was observed. All the p values obtained for different drug and drug combinations are summarized in Figure 5. A complete analysis of sensitivity of isolates towards different drug combinations is shown in Figure 4.

4. Conclusion:

The study is focused on the drug sensitivity analysis of *Candida* isolates towards various drugs and their combinations. Four different classes of drugs used for the study belonged to different classes with a different mechanism of action (Itraconazole, Amphotericin B, Micafungin and Terbinafine). Results have shown that the monotherapy drugs were not as efficacious. Thus, combinatorial drugs were prepared and analyzed at three different stoichiometric ratios.

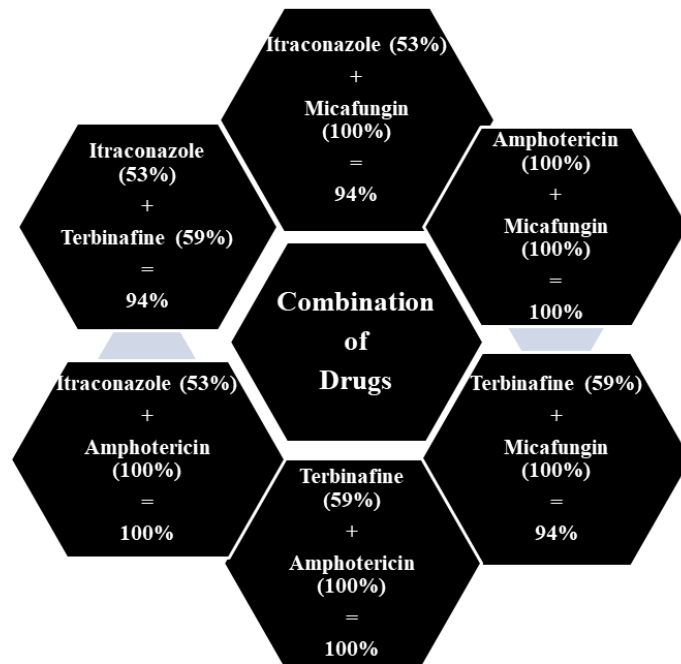

The results from this study showed that different isolates showed maximum sensitivities to the combinatorial drugs at all proportions. Most of the combinations were statistically significant from drug monotherapy except for Amphotericin B.

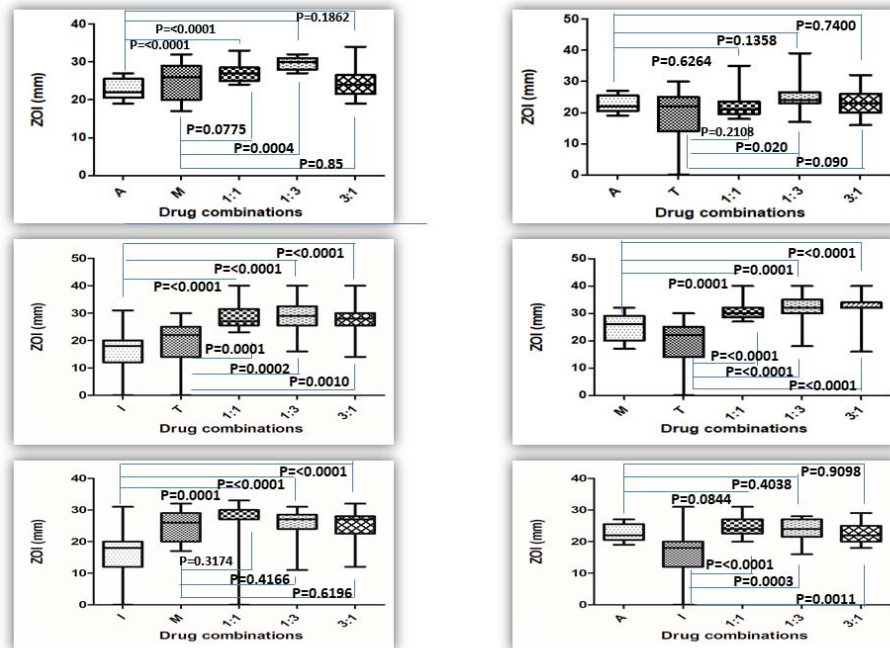

No statistical significance was observed between the three different proportions of drug combinations. Combination therapy could provide an alternative to monotherapy for patients with invasive infections that are difficult to treat due to the emergence of resistance.

References:

Abi Said, D., Anaissie, E., Uzun, O., Raad, I., Pinzcowski, H., & Vartivarian, S. (1997). The

- Epidemiology of Hematogenous Candidiasis Caused by Different Candida Species. *Clinical Infectious Diseases*, 24(6), 1122–1128. <https://doi.org/10.1086/513663>
- Achkar, J.M., Fries, B.C., Candida infections of the Genitourinary Tract (2010). *Clinical Microbiology reviews*, Apr. 2010, p. 253–273 Vol. 23, No. 20893-8512/10. <https://doi.org/10.1128/CMR.00076-09>
- Ahmed, A., Azim, A., Gurjar, M., Baronia, A.K. (2014) Current concepts in combination Antibiotic therapy for critically ill patients. *Indian Journal of Critical Care Medicine* May 2014 Vol 18 Issue 5
- Alrayyes, S.F., Alruwaili, H.M., Taher, I.A., Elrahawy, K.M., Almaeen, A.H., Ashekhi, A.O., and Alam, M.K. (2019). Oral Candidal carriage and associated risk indicators among adults in Sakaka, Saudi Arabia. *BMC Oral Health* (2019) <https://doi.org/10.1186/s12903-019-0775-8>
- Babic, M., Hukic, M. (2010). Candida Albicans and Non-Albicans species as etiological agents of vaginitis in pregnant and non- pregnant women. *Bosnian journal of basic medical sciences* 2010; 10 (1): 89-97
- Barchiesi, F., Di Francesco, L. F., & Scalise, G. (1997). In vitro activities of terbinafine in combination with fluconazole and itraconazole against isolates of Candida albicans with reduced susceptibility to azoles. *Antimicrobial Agents and Chemotherapy*, 41(8), 1812–1814. <https://doi.org/10.1128/aac.41.8.1812>
- Barchiesi F, Orsetti E, Mazzanti S, Trave F, Salvi A, Nitti C, et al. (2017) Candidemia in the elderly: What does it change? *PLoS ONE* 12(5): e0176576. <https://doi.org/10.1371/journal.pone.0176576>
- Behzadi, P., Behzadi, E., Ranjbar, R., (2015). Urinary tract infections and *Candida albicans*. *Cent European J Urol*. 2015; 68: 96-101. <https://doi.org/10.5173/ceju.2015.01.474>
- Bhattacharjee, P. (2016). Epidemiology and antifungal susceptibility of Candida species in a tertiary care hospital, Kolkata, India. *Current Medical Mycology*, 2(2), 0–0.

<https://doi.org/10.18869/acadpub.cmm.2.2.5>

Bitew, A., & Abebaw, Y. (2018). Vulvovaginal candidiasis: Species distribution of *Candida* and their antifungal susceptibility pattern. *BMC Women's Health*, 18(1), 1–10.

<https://doi.org/10.1186/s12905-018-0607-z>

Candoni, A., Aversa, F., Busca, A., Cesaro, S., Girmenia, C., Luppi, M., Rossi, G., Venditti, A., Nosari, A.M., Pagano, L. (2015). Combination antifungal therapy for invasive mould Diseases in haematologic patients. An update on clinical data. *Journal of Chemotherapy* 2015 VOL. 27. <https://doi.org/10.1179/1973947814Y.0000000224>

Chowdhary, A., Tarai, B., Singh, A., Sharma, A. (2020). Multidrug – Resistant *Candida auris* Infections in critically ill corona virus disease patients, India, April – July 2020. *Emerging Infectious Diseases*, <https://doi.org/10.3201/eid2611.203504>

CRABTREE, E. G., & PRATHER, G. C. (1933). Urinary Tract Infections Associated With Pregnancy. *Journal of the American Medical Association*, 101(25), 1928.

<https://doi.org/10.1001/jama.1933.02740500008003>

Cuenca-Estrella, M. (2004). Combinations of antifungal agents in therapy - What value are they? *Journal of Antimicrobial Chemotherapy*, 54(5), 854–869.

<https://doi.org/10.1093/jac/dkh434>

Da Costa, K. R. C., Ferreira, J. C., Komesu, M. C., & Candido, R. C. (2009). *Candida albicans* and *Candida tropicalis* in oral candidosis: Quantitative analysis, exoenzyme activity, and antifungal drug sensitivity. *Mycopathologia*, 167(2), 73–79. <https://doi.org/10.1007/s11046-008-9154-8>

Dan, M., Poch, F., Levin, D (2002). High rate of vaginal infections caused by non *C. albicans* candida species among asymptomatic women. *Medical Mycology* 2002, 40, 383–386.

Darma, S., Ambara, A., Aman, A.T., Annisa, L., Nurrokhman, Nuryastuti T, Wibawa, T.,(2020) High frequency of azole resistant *Candida spp.* colonization among presumptive multidrug resistant tuberculosis (MDR-TB) patients. *PLoS ONE* 15(11): e0242542.

<https://doi.org/10.1371/journal.pone.0242542>

Deorukhkar, S. C., Saini, S., & Mathew, S. (2014). Non- albicans *Candida* infection: An

emerging threat. *Interdisciplinary Perspectives on Infectious Diseases*, 2014.

<https://doi.org/10.1155/2014/615958>

Dermawan, J. K. T., Ghosh, S., Keating, M. K., Gopalakrishna, K. V., & Mukhopadhyay, S. (2018). Candida pneumonia with severe clinical course, recovery with antifungal therapy and unusual pathologic findings. *Medicine (United States)*, 97(2), 1–5.

<https://doi.org/10.1097/MD.00000000000009650>

Flevari, A., Theodorakopoulou, M., Velegraki, A., Armaganidis, A., & Dimopoulos, G. (2013). Treatment of invasive candidiasis in the elderly: A review. *Clinical Interventions in Aging*, 8, 1199–1208. <https://doi.org/10.2147/CIA.S39120>

Fu, J., Ding, Y., Wei, B., Wang, L., Xu, S., Qin, P., Wei, L., Jiang, L. (2017). Epidemiology of Candida albicans and non-C.albicans of neonatal candidemia at a tertiary care hospital in western China. *BMC Infectious Diseases* (2017) 17:329. <https://doi.org/10.1186/s12879-017-2423-8>

Ghannoum, M. A., & Elewski, B. (1999). Successful treatment of fluconazole-resistant oropharyngeal candidiasis by a combination of fluconazole and terbinafine. *Clinical and Diagnostic Laboratory Immunology*, 6(6), 921–923. <https://doi.org/10.1128/cdli.6.6.921-923.1999>

Glöckner, A., & Cornely, O. A. (2015). Candida glabrata - unique features and challenges in the clinical management of invasive infections. *Mycoses*, 58(8), 445–450. <https://doi.org/10.1111/myc.12348>

Harris, A. D., Castro, J., Sheppard, D. C., Carmeli, Y., & Samore, M. H. (1999). Risk Factors for Nosocomial Candiduria Due to Candida glabrata and Candida albicans. *Clinical Infectious Diseases*, 29(4), 926–928. <https://doi.org/10.1086/520460>

Hay, R. J. (1999). Therapeutic potential of terbinafine in subcutaneous and systemic mycoses. *British Journal of Dermatology, Supplement*, 141(56), 36–40. <https://doi.org/10.1046/j.1365-2133.1999.00013.x>

Hu, Y., Hu, Y., Lu, Y., Huang, S., Liu, K., Han, X., Mao, Z., Wu, Z., Zhou, X. (2016). A Case Report of Penile Infection Caused by Fluconazole- and Terbinafine-Resistant Candida

- Albicans. Mycopathologia.* <https://doi.org/10.1007/s11046-016-0070-z>
- Huffnagle, G.B., Pendleton, K.M., Dickson, R.P., Newton, D.W., Hoffman, T.C., Yanik, G.A. (2018). Respiratory Tract Colonization by *Candida* species Portends Worse Outcomes in Immunocompromised Patients. *Clin Pulm Med.* 2018 November ; 25(6): 197–201. [Hhttps://doi.org/10.1097/CPM.0000000000000279](https://doi.org/10.1097/CPM.0000000000000279).
- Jensen, R. H., Astvad, K. M. T., Silva, L. V., Sanglard, D., Jørgensen, R., Nielsen, K. F., Mathiasen, E. G., Doroudian, G., Perlin, D. S., & Arendrup, M. C. (2015). Stepwise emergence of azole, echinocandin and amphotericin B multidrug resistance in vivo in *Candida albicans* orchestrated by multiple genetic alterations. *Journal of Antimicrobial Chemotherapy*, 70(9), 2551–2555. <https://doi.org/10.1093/jac/dkv140>
- Johnson, M. D., Macdougall, C., Perfect, J. R., Rex, J. H., & Ostrosky-zeichner, L. (2004). Combination Antifungal Therapy minireview Combination Antifungal Therapy. *Society*, 48(3). <https://doi.org/10.1128/AAC.48.3.693>
- Kim, J., Sudbery, P. (2011). *Candida albicans* A major human fungal pathogen. *The Journal of Microbiology* (2011) Vol. 49, No. 2, pp. 171-177. <https://doi.org/10.1007/s12275-011-1064-7>
- Laupland, K.B., Gregson, D.B., Church, D.L., Ross, D., Elsayed, S. (2005). Invasive *Candida* Species infections: a 5 year population-based assessment. *Journal of Antimicrobial Chemotherapy* (2005) 56, 532–537. <https://doi.org/10.1093/jac/dki258>
- Loster, J.E., Wiczorek, A., Loster, B.W. (2016). Correlation between age and gender in *Candida* Species infections of complete denture wearers: a retrospective analysis. *Clinical Interventions in Aging* 2016:11 1707–1714
- Mäkinen A, Nawaz A, Mäkitie A, Meurman JH, Role of non-*albicans Candida* and *Candida albicans* in oral squamous cell cancer patients, *Journal of Oral and Maxillofacial Surgery* (2018), <https://doi.org/10.1016/j.joms.2018.06.012>
- Martín-Peña, A., Aguilar-Guisado, M., Espigado, I., Cisneros, J.M. (2014) Antifungal combination therapy for invasive aspergillosis, *Clin Infect Dis.* 2014 Nov 15;59(10):1437–45. <https://doi.org/10.1093/cid/ciu581>. Epub 2014 Jul 21.

- Odds, F. C. (1982). Interactions among amphotericin B, 5-fluorocytosine, ketoconazole, and miconazole against pathogenic fungi in vitro. *Antimicrobial Agents and Chemotherapy*, 22(5), 763–770. <https://doi.org/10.1128/AAC.22.5.763>
- Pendleton, K.M., Huffnagle, G.B., Dickson, R.P. (2017). The significance of *Candida* in the human respiratory tract: our evolving understanding, *Pathogens and Disease*, 75, 2017. <https://doi.org/10.1093/femspd/ftx029>
- Perea, S., Gonzalez, G., Fothergill, A.W., Sutton, D.A., Rinaldi, M.G. (2002). In Vitro Activities of Terbinafine in Combination with Fluconazole, Itraconazole, Voriconazole, and Posaconazole against Clinical Isolates of *Candida glabrata* with Decreased Susceptibility to Azoles. *Journal of clinical microbiology*, May 2002, p. 1831–1833 Vol.40, No. 5 0095-1137/02. <https://doi.org/10.1128/JCM.40.5.1831-1833.2002>.
- Rautemaa, R., Richardson, M., Pfaller, M.A., Perheentupa, J., Saxen, H. (2008). Activity of amphotericin B, anidulafungin, caspofungin, micafungin, posaconazole, and voriconazole against *Candida albicans* with decreased susceptibility to fluconazole from APECED patients on long-term azole treatment of chronic mucocutaneous candidiasis. *Diagnostic Microbiology and Infectious Disease* 62 (2008) 182–185. <https://doi.org/10.1016/j.diagmicrobio.2008.05.007>
- Rodríguez-Cerdeira C, Martínez-Herrera E, Carnero-Gregorio M, López-Barcenas A, Fabbrocini G, Fida M, El-Samahy M and González-Cespón JL (2020) Pathogenesis and Clinical Relevance of *Candida* Biofilms in Vulvovaginal Candidiasis. *Front. Microbiol.* 11:544480. <https://doi.org/10.3389/fmicb.2020.544480>
- Roling, E. E., Klepser, M. E., Wasson, A., Lewis, R. E., Ernst, E. J., & Pfaller, M. A. (2002). Antifungal activities of fluconazole, caspofungin (MK0991), and anidulafungin (LY 303366) alone and in combination against *Candida* spp. and *Cryptococcus neoformans* via time-kill methods. *Diagnostic Microbiology and Infectious Disease*, 43(1), 13–17. [https://doi.org/10.1016/S0732-8893\(02\)00361-9](https://doi.org/10.1016/S0732-8893(02)00361-9)
- Salehi, M., Ahmadikia, K., Mahmoudi S., Kalantari, S., Siahkali, S.J., Izadi, A., Kord, M., Manshadi, S.A.D., Seifi, A., Ghiasvand, F., Khajavirad N., Ebrahimi, S., Koohfar, A., Boekhout, T., Khodavaisy, S. (2020), Oropharyngeal candidiasis in hospitalized COVID-

19 Patients from Iran: Species identification and antifungal susceptibility pattern,
[https://doi.org/ 10.1111/MYC.13137](https://doi.org/10.1111/MYC.13137)

Santhanam, J., Yahaya, N., & Aziz, M. N. (2013). Species distribution and antifungal susceptibility patterns of candida species: Is low susceptibility to itraconazole a trend in Malaysia? *Medical Journal of Malaysia*, 68(4), 343–347.

Song, G., Liang, G., Liu, W. (2020). Fungal Co-infections associated with global COVID-19 pandemic: A clinical and diagnostic perspective from China. *Mycopathologia*. 2020 Jul 31 : 1–8, <https://doi.org/10.1007/s11046-020-00462-9>

Soni, S., Pudake, R.M., Jain, U., Chauhan, N., (2021). A systematic review on SARS-CoV-2-associated fungal coinfections. *Journal of medical virology*, <https://doi.org/10.1002/jmv.27358>

Strati, F., Di Paola, M., Stefanini, I., Albanese, D., Rizzetto, L., Lionetti, P., Calabrò, A., Jousson, O., Donati, C., Cavalieri, D., De Filippo, C. (2016) Age and Gender Affect the Composition of Fungal Population of the Human Gastrointestinal Tract. *Front. Microbiol.* 7:1227. doi: 10.3389/fmicb.2016.01227

Sugar, A. M., Hitchcock, C. A., Troke, P. F., & Picard, M. (1995). Combination therapy of murine invasive candidiasis with fluconazole and amphotericin B. *Antimicrobial Agents and Chemotherapy*, 39(3), 598–601. <https://doi.org/10.1128/AAC.39.3.59>

Sun, L., Wan, Z., Li, R., Yu, J. (2019). *In vitro* activities of six antifungal agents and their Combinations against *Chaetomium* spp. *Journal of Medical Microbiology* 2019; 68:1042–1046. <https://doi.org/10.1099/jmm.0.001004>

Tortelli, B.A., Lewis, W.G., Allsworth, J.E., Menh, N.M., Foster, L.R., Reno, H.E., Peipert, J.F., Fay, J.C., Lewis, A.L. (2020) Associations between the vaginal microbiome and *Candida* colonization in women of reproductive age. *Am J Obstet Gynecol*. 2020 May ; 222(5): 471.e1–471.e9. <https://doi.org/10.1016/j.ajog.2019.10.008>

Touil, H.F.Z., Otmani, Z.B., Boucherit, K. (2018) In vitro activity of antifungal combinations against planktonic and sessile cells of *Candida albicans* isolated from medical Devices in an

Intensive care department. Journal De Mycologie Me´ dicale (2018),
[https://doi.org/ 10.1016/j.mycmed.2018.06.008](https://doi.org/10.1016/j.mycmed.2018.06.008)

Declarations:

Funding: The research was funded by the Intramural Research Scientific Committee at Dr. B. Lal Institute of Biotechnology.

Conflicts of interests/Competing interests: The authors declare no competing interests.

Consent to participate: The authors have complete consent for the study.

Consent for publication: The authors have complete consent for publication.

Availability of data and material: The isolates were kindly provided by Microbial Culture Repository Division, Centre for Innovation, Research and Development, Dr. B. Lal Clinical Laboratory Pvt. Ltd., Jaipur.

Code availability: Not applicable.

Authors' Contribution: SA performed the experiments and wrote the manuscript; SP, BJ, SNP, SM, HP and RKP performed the experiments; RN, SKS provided the isolates; AK designed the research, planned the experiments, performed formal analysis of the results & wrote the manuscript.