

Genomic diversity and antimicrobial resistance of *Prevotella* spp. isolated from chronic lung disease airways

Kasey A. Webb^{1,2}, Olusola Olagoke^{1,2}, Timothy Baird^{2,3}, Jane Neill³, Amy Pham⁴, Timothy J. Wells⁴,
Kay A. Ramsay^{5†}, Scott C. Bell^{5,6,7}, Derek S. Sarovich^{1,2*#}, and Erin P. Price^{1,2*#}

¹GeneCology Research Centre, University of the Sunshine Coast, Sippy Downs, QLD, Australia

²Sunshine Coast Health Institute, Birtinya, QLD, Australia

³Sunshine Coast Hospital and Health Service, Sunshine Coast University Hospital, Birtinya, QLD, Australia

⁴University of Queensland Diamantina Institute, The University of Queensland, Woolloongabba, QLD, Australia

⁵QIMR Berghofer Medical Research Institute, Herston, QLD, Australia

⁶Adult Cystic Fibrosis Centre, The Prince Charles Hospital, Chermside, QLD, Australia

⁷Translational Research Institute, Woolloongabba, QLD, Australia

†Present address: Child Health Research Centre, The University of Queensland, Centre for Children's Health Research, South Brisbane, QLD, Australia

*Authors contributed equally to this work

#Corresponding authors

University of the Sunshine Coast, Locked Bag 4, Maroochydore DC, Qld, 4558, Australia

Email: dsarovich@usc.edu.au; Ph: +61 5456 3748

Email: eprice@usc.edu.au; Ph: +61 7 5456 5568

Key Words: *Prevotella*, genomics, cystic fibrosis, chronic obstructive pulmonary disease, respiratory infections, polymicrobial infections, real-time PCR, diagnostics, sputum

1 **Data summary**

2 Thirty-five *Prevotella* spp. genomes generated in this study are available in the Sequence Read

3 Archive (SRA) and GenBank databases under BioProject accession PRJNA742126.

4 **Abstract**

5 Cystic fibrosis (CF) and chronic obstructive pulmonary disease (COPD) are characterised by
6 increasingly frequent acute pulmonary exacerbations that reduce life quality and length. Human
7 airways are home to a rich polymicrobial environment, including members of the obligately anaerobic
8 genus, *Prevotella*. Despite their commonness, surprisingly little is known about the prevalence, role,
9 genomic diversity, and antimicrobial resistance (AMR) potential of *Prevotella* species/strains in
10 healthy and diseased airways. Here, we used comparative genomics to develop a real-time PCR
11 assay to permit rapid *Prevotella* spp. quantification from cultures and clinical specimens. Assay
12 specificity was validated across a panel of *Prevotella* and non-*Prevotella* species, followed by PCR
13 screening of CF and COPD respiratory-derived cultures. Next, 35 PCR-positive isolates were
14 subjected to whole-genome sequencing. Of eight identified species, *P. histicola*, *P. melaninogenica*,
15 *P. nanceiensis*, *P. salivae* and *P. denticola* overlapped between participant cohorts. Phylogenomic
16 analysis revealed considerable interhost but limited intrahost diversity, suggesting patient-specific
17 lineages in the lower airways, probably from oral cavity aspirations. Correlation of phenotypic AMR
18 profiles with AMR gene presence identified excellent correlation between *tetQ* presence and
19 decreased doxycycline susceptibility, and *ermF* presence and decreased azithromycin susceptibility
20 and clindamycin resistance. AMR rates were higher in the CF isolates, reflecting greater antibiotic use
21 in this cohort. All tested *Prevotella* isolates were tobramycin-resistant, providing a potential selection
22 method to improve *Prevotella* culture retrieval rates. Our addition of 35 airway-derived *Prevotella*
23 genomes to public databases will enhance ongoing efforts to unravel the role of this diverse and
24 enigmatic genus in both chronic respiratory diseases and healthy lungs.

25 Introduction

26 Chronic lung diseases are a leading cause of global healthcare burden and early mortality^{1,2}. Although
27 cystic fibrosis (CF) and chronic obstructive pulmonary disease (COPD) have fundamentally different
28 aetiologies, both are characterised by impaired airway mucociliary clearance, which provides a
29 favourable environment for microbial colonisation and persistence, and a challenging environment for
30 pathogen eradication. Infections are the primary contributor in CF and COPD respiratory
31 exacerbations (i.e. acute worsening of symptoms), during which inflammation and irreversible airway
32 damage can occur³. In CF, 80-95% of deaths are associated with acute exacerbations and chronic
33 bacterial infections, which eventually lead to respiratory failure⁴. In COPD, bacterial, viral, and fungal
34 respiratory infections trigger ~70-80% exacerbation events⁵. Despite their crucial role in reducing
35 quality and length of life, there remain major gaps in understanding the collective microbial drivers
36 associated with CF and COPD pathophysiology.

37 Routine culture-based diagnosis of CF and COPD exacerbations often overlooks more fastidious or
38 uncultivable members within the airway microbiome, leaving a gap in fully understanding the complex
39 composition and activity of CF and COPD microbiomes^{6,7}. Culture-independent techniques like
40 metataxonomics (e.g. 16S rRNA amplicon sequencing), metagenomics, and metatranscriptomics are
41 gaining traction as adjuncts or potentially even alternatives to culture due to their ability to identify a
42 much broader spectrum of microbes, including uncultured taxa, resulting in better diagnosis, more
43 informed treatment strategies, and improved clinical outcomes⁸⁻¹⁰. In addition to identifying well-
44 characterised microbes associated with respiratory exacerbations, molecular methods have unveiled
45 previously unidentified microbial communities in chronic lung disease airways, including a diverse
46 anaerobic microbiome¹¹.

47 The *Prevotella* genus, which comprises ≥ 51 species^{12,13}, is a common and often abundant obligate
48 anaerobe in the human body, including in CF and COPD airways^{11,14-19}. Despite its commonness, the
49 role of *Prevotella* in disease progression is incompletely understood in CF¹¹, and even less so in
50 COPD. Several studies investigating *Prevotella* spp. in airway disease, particularly CF, have yielded
51 conflicting evidence. Some studies suggest a likely pathogenic role^{18,20}, whereas others have shown
52 no role²¹, or even a benefit when *Prevotella* spp. are abundant^{22,23}. A major contributor to these
53 equivocal findings is that culture-dependent and metaxonomic methods largely fail to identify

54 microbes to the species and strain level^{7,13,24,25}. As such, only a handful of *Prevotella* studies have
55 described potential species- or strain-specific mechanisms in airway disease pathogenesis.

56 The number of *Prevotella* genomes has been steadily increasing in recent years. However, in
57 comparison to more intensely studied CF and COPD airway organisms, there is a relative paucity of
58 respiratory *Prevotella* genomic data in public databases. Most *Prevotella* species contain only a single
59 representative (and many were generated from a single metagenomic study)²⁶, leading to issues with
60 correct species assignments from metagenome-assembled genomes. Further, most genomic studies
61 have concentrated on known pathogens in oral (e.g. *P. intermedia* and *P. nigrescens*), gut (e.g. *P.*
62 *copri*), and urogenital (e.g. *P. bivia*) microbiomes²⁷⁻²⁹. There is a lack of knowledge about the
63 *Prevotella* spp. commonly found in airways, particularly in COPD. Insufficient resolution to the species
64 and strain level has limited our understanding of *Prevotella* spp. diversity, function, evolution, and
65 antimicrobial resistance (AMR) potential within CF and COPD airways during exacerbations and
66 stability^{13,24}.

67 Here, we first used a comparative genomics approach to design and optimise a novel real-time PCR
68 assay to permit the rapid, cost-effective, and specific detection of *Prevotella* spp. from both culture
69 and clinical specimens. Next, 43 CF-COPD sputa and bronchial washings were cultured to isolate
70 individual *Prevotella* strains for whole-genome sequencing (WGS) characterisation, followed by
71 genomic analyses to determine species identity, strain relatedness, and within-host evolution.
72 Cultured isolates were subject to AMR testing across 11 clinically-relevant antibiotics, and correlated
73 with AMR determinants identified by WGS. Finally, *Prevotella* morphological characteristics were
74 assessed for their diagnostic value.

75 **Methods**

76 Ethics statement. Collection and analysis of clinical samples was approved by The Prince Charles
77 Hospital (TPCH) Human Research Ethics Committee (HREC), project IDs HREC/13/QPCH/127 (CF
78 samples) and HREC/2019/QPCH/48013 (COPD samples). Site-specific approvals were obtained for
79 CF recruitment at TPCH, Brisbane, Australia, and COPD recruitment at Sunshine Coast Hospital and
80 Health Service, Sunshine Coast, Australia. All participants provided written consent.

81 Sample collection and storage. A total of 36 CF sputa were obtained from 21 expectorating adults
82 with CF presenting at TPCH Adult CF Centre between 2017 and 2019. Seven participants provided
83 multiple sequential sputa (**Table S1**). Sputa were stored non-anaerobically at -80°C in Luria-Bertani
84 broth containing 20% glycerol, and stored for 2-24 months prior to microbiological assessment. A total
85 of 32 COPD sputa ($n=21$) or bronchial washings (BW; $n=11$) were obtained from 21 current/former
86 tobacco smokers during community or in-hospital consult at Sunshine Coast Hospital and Health
87 Service in 2020 (**Table S1**). Five participants provided multiple sequential sputa (**Table S1**). BWs
88 were taken from participants with suspected lung cancer, with most collected as paired specimens
89 from both the tumour site (biopsied after BW collection) and approximately the same position in the
90 non-tumour contralateral (contra) lung. BWs were pelleted at 4°C and ~9,300 x g for 15 min, with
91 supernatant removed and pellet resuspended in 800 µL phosphate-buffered saline. COPD samples
92 were stored within 12-36 hours of collection using the same parameters as described for the CF
93 specimens, and microbiologically processed within ~2 weeks of collection. Clinical and antibiotic
94 treatment regimens were recorded (**Table S1**) to permit correlation with *Prevotella* AMR profiles.

95 Microbiological preparation and storage. Clinical samples were directly subcultured onto anaerobic
96 blood medium containing nalidixic acid and vancomycin (Thermo Fisher Scientific, Seventeen Mile
97 Rocks, QLD, Australia; cat. no. PP2065). Plates were incubated anaerobically at 37°C in an
98 AnaeroPack 2.5L jar with an AnaeroGen 2.5L gas pack (Thermo Fisher) for 2-5 days. Isolates were
99 subcultured based on different morphotypes, with a second subculture for purity onto non-selective
100 anaerobic blood medium (Thermo Fisher; cat. no. PP2039). *Prevotella* real-time PCR-positive isolates
101 were again sub-cultured onto non-selective anaerobic blood medium for purity and stored non-
102 anaerobically at -80°C in 1mL Luria-Bertani broth containing 20% glycerol. Additionally, WGS-
103 confirmed, representative *Prevotella* isolates derived from CF samples were cultured from glycerol
104 stocks onto both polyvitaminic-supplemented chocolate agar (PVCA; Edwards Group, Murrarie, QLD,

105 Australia; cat. no. 1065) and non-selective anaerobic blood medium to assess phenotypic differences
106 over a 10-day period.

107 DNA extractions. DNA of presumptive *Prevotella* spp. isolates was initially extracted using 5% chelex-
108 100³⁰ (Bio-Rad, Gladesville, NSW, Australia), heat-treated at 95°C for 20 min, and diluted to 1:50 with
109 molecular-grade H₂O prior to PCR. DNA for WGS was extracted using the Gram-positive bacteria
110 protocol of the DNeasy Blood and Tissue Kit (Qiagen, Chadstone, VIC, Australia). Qiagen extractions
111 were quality-checked and quantified using the NanoDrop 2000 spectrophotometer (Thermo Fisher).

112 Clinical specimens were extracted using 3 parts TRI Reagent LS (Sigma-Aldrich, North Ryde, NSW,
113 Australia) to 1 part specimen, 30µL 0.1M 2-mercaptoethanol, and ~ 100µL equal mixture of 0.1 and
114 0.5mm zirconia beads (Daintree Scientific, St Helens, TAS, Australia). Homogenisation comprised
115 eight rounds of 30 sec bead beating (each round followed by 30-60 sec on wet ice) using the
116 'medium' setting of the Minilys tissue homogeniser (Bertin Instruments, Montigny-le-Bretonneux,
117 France). After removal of the RNA aqueous phase, back extraction was performed on the interphase
118 and proteinaceous phase³¹ to isolate total DNA.

119 *Prevotella* spp. real-time PCR assay design. Due to high levels of genetic variability among *Prevotella*
120 spp., the highly conserved 16S-23S rRNA genes were targeted. A custom BLAST³² 2.10.2+ database
121 was created using 60 *Prevotella* spp. genomes encompassing 26 assigned and nine unassigned
122 species (**Table S2**). Discontiguous MegaBLAST was carried out against the 4.8kb *P. intermedia*
123 ATCC 25611 23S-16S rRNA locus (GenBank accession CP019300.1, coordinates 63001-67800)
124 using the custom BLAST database. BLAST .xml outputs were aligned and visualised using Geneious
125 Prime vR10. A highly conserved area within the *Prevotella* spp. 16S rRNA gene was assessed further
126 to identify potential PCR oligos, with conserved regions possessing several single nucleotide
127 polymorphisms (SNPs) in other microbes exploited during probe and primer design. Primers and
128 probes were initially assessed using Primer Express v3.0 (Applied Biosystems) to test melting
129 temperature (T_m) suitability in Black Hole Quencher format (primer $T_m=60^\circ\text{C}$; probe $T_m=70^\circ\text{C}$). All
130 candidate primers and probes were assessed for self- and hetero-dimer formation using Beacon
131 Designer (<http://www.premierbiosoft.com/qpcr/>), with oligo sequences requiring a ΔG value of >-4
132 kcal/mol. Candidate oligos were subsequently subjected to NCBI Microbial Nucleotide BLAST and
133 Nucleotide BLAST searches to confirm specificity for *Prevotella* spp.. As the 16S region is highly
134 conserved in all bacteria, the forward primer incorporated a penultimate mismatch to prevent non-

135 specific binding to closely related non-*Prevotella* taxa. Additionally, a BHQplus probe (CAL Fluor Gold
136 540-pdCApdUApdUpdCGApdCGGGGpgUGG-BHQ1; Biosearch Technologies, Petaluma, California,
137 USA) was included to enhance specificity and to permit assay use on clinical specimens. Forward (5'-
138 TTCTCCAGtCCAGGATGTGtC-3') and reverse (5'-CGGGGATAACAGGCTGATCC-3') primers were
139 manufactured by Macrogen Inc. (Geumcheon-gu, Seoul, South Korea), with lowercase nucleotides
140 representing intentional mismatches.

141 Real-time PCRs were carried out on a Bio-Rad CFX96 thermocycler using 0.35µM primers and probe,
142 1X Sso Advanced Universal mastermix (Bio-Rad), molecular-grade H₂O, and 1µL template, to a 5µL
143 final volume. Thermocycling parameters were: 95°C for 2 min, followed by 45 cycles of 95°C for 5 sec
144 and 60°C for 20 sec. DNA integrity for all clinical samples was assessed via amplification towards β-
145 globin³³ (human) and universal 16S rRNA³⁴ (bacteria); the universal 16S rRNA assay was also used
146 to verify bacterial culture DNA integrity, and a panfungal assay (O. Olagoke and E. Price,
147 unpublished) was used to verify *Candida* spp. DNA integrity.

148 Real-time PCR assay optimisation and specificity testing. The final optimised real-time PCR assay
149 was assessed for accuracy by running against a diversity panel of six *Prevotella* spp. (one each of *P.*
150 *copri*, *P. denticola*, *P. histicola*, *P. melaninogenica*, *P. nigrescens*, and *P. salivae*), 1 human DNA
151 sample, and 40 non-*Prevotella* spp., with a focus on common respiratory tract microbes ($n=1$ unless
152 otherwise stated): *Achromobacter xylosoxidans*, *Bordetella bronchiseptica*, *Burkholderia cepacia*,
153 *Burkholderia territorii*, *Burkholderia thailandensis*, *Candida albicans*, *Candida dubliniensis*,
154 *Cupriavidus metallidurans*, *Enterobacter aerogenes*, *Enterobacter cloacae* ($n=3$), *Enterococcus*
155 *raffinosis*, *Klebsiella oxytoca*, *Klebsiella pneumoniae* ($n=2$), *Lactocaseibacillus paracasei* ($n=2$),
156 *Pseudomonas aeruginosa* ($n=12$), *Staphylococcus aureus* ($n=3$), *Staphylococcus haemolyticus*,
157 *Stenotrophomonas maltophilia*, *Veillonella atypica* ($n=3$), *Veillonella parvula*, and *Veillonella dispar*. All
158 DNA was normalised spectrophotometrically to 2ng/µL prior to PCR.

159 Limits of detection (LoD) and quantification (LoQ) for the optimised assay were determined using *P.*
160 *melaninogenica* LMG 28911 DNA, using serial dilutions of 4ng/µL to 4×10^{-6} ng/µL across 8 replicates
161 per dilution. The upper and lower LoD/LoQ limits were determined as described elsewhere³⁵. Genome
162 equivalence was determined based on an average *Prevotella* genome size of 3.29Mbp and a single
163 copy of the 16S rRNA gene.

164 16S rRNA gene diversity profiling (metataxonomics). Metataxonomics was performed by the
165 Australian Genome Research Facility (AGRF; Melbourne, VIC, Australia) for total CF DNA and ID
166 Genomics (Seattle, WA, USA) for total COPD DNA using standard protocols for V3-V4 (i.e. 341F and
167 806R) primers.

168 Antimicrobial resistance (AMR) profiling. Twenty-eight glycerol-stocked *Prevotella* cultures were
169 subcultured onto non-selective anaerobic blood medium, or PVCA where no growth was obtained on
170 the anaerobic medium ($n=2$), and incubated at 37°C under anaerobic conditions for 2-3 days. Cultures
171 were then resuspended into phosphate-buffered saline to $OD_{600}=0.75$ (Biochrom, Cambridge, UK).
172 Six supplemented chocolate plates per isolate were lawn-inoculated with the OD-normalised cells as
173 previously described³⁶, and antibiotic discs (Edwards Group) towards 11 antibiotics (amoxicillin-
174 clavulanate [AMC] 30µg; azithromycin [AZM] 15ug; ceftazidime [CAZ] 30µg; chloramphenicol [CHL]
175 30µg; clindamycin [CLI] 2µg; doxycycline [DOX] 30µg; imipenem [IPM] 30µg; meropenem [MEM]
176 10µg; metronidazole [MZ] 5µg; piperacillin-tazobactam [TZP] P:100µg, TZ:10µg; tobramycin [TOB]
177 10µg) were placed onto inoculated plates. Plates were incubated at 37°C under anaerobic conditions
178 for 48h prior to measurement. As no disc diffusion reference ranges exist for *Prevotella* spp., growth
179 up to the disc (i.e. 6mm diameter) was denoted as AMR, which underestimates the true rate of AMR
180 but provides a clear cut-off for unambiguous interpretation. Diameters ≤ 30 mm for any antibiotic were
181 denoted as reduced susceptibility.

182 Whole-Genome Sequencing (WGS). PCR-confirmed *Prevotella* isolates were sequenced using the
183 Illumina HiSeq 2500 platform with 150bp seqWell plexWell paired-end read chemistry at AGRF.

184 Genome assemblies. *Prevotella* genomes were *de novo* assembled using default Microbial Genome
185 Assembly Pipeline v1.1 parameters ([https://github.com/dsarov/MGAP---Microbial-Genome-](https://github.com/dsarov/MGAP---Microbial-Genome-Assembler-Pipeline)
186 [Assembler-Pipeline](#)) or SPAdes³⁷.

187 Speciation and mixture analysis. *Prevotella* spp. assemblies were initially assessed for species
188 identification and mixtures using the Ribosomal MLST³⁸ tool. Isolates containing mixtures of
189 *Prevotella* and non-*Prevotella* species ($n=8$), or multiple *Prevotella* species ($n=1$) (**Table S3**), were
190 excluded from further investigation.

191 Phylogenetic analysis. A custom BLAST database of *Prevotella* genomes ($n=234$) comprising taxa of
192 known ($n=56$) and unassigned ($n=40$) species, and including non-mixed isolate genomes sequenced

193 in this study ($n=35$ genomes), was created using BLAST 2.10.2+. BLAST analysis was performed
194 against the full-length 1,534bp *P. melaninogenica* 16S rRNA gene (RefSeq ID: NC_014371.1; bases
195 962,784-964,317). Hits were filtered to remove redundancies (final $n=199$), and reads aligned using
196 ClustalX2 v2.1³⁹. A dendrogram was constructed using the neighbour-joining method and the Tamura-
197 Nei model and viewed in FigTree v1.4.0 (<http://tree.bio.ed.ac.uk/software/figtree/>) using midpoint
198 rooting.

199 Phylogenomics. Variant identification of our CF-COPD genomes ('SCHI' prefix) was performed using
200 SPANDx v4.0⁴⁰. Reference genomes for *P. denticola*, *P. histicola*, *P. melaninogenica*, *P. nanceiensis*,
201 and *P. salivae* were downloaded from GenBank (IDs GCA_000193395.1, GCA_000234055.1,
202 GCA_000144405.1, GCA_000163055.2, and GCA_000477535.1, respectively) and used for read
203 mapping. Synthetic reads were generated from GenBank genome assemblies for *P. denticola*
204 (GCA_000191765.2, GCA_000759205.1, GCA_000421205.1, GCA_003515045.1, and
205 GCA_900454835.1), *P. histicola* (GCA_000613925.1), *P. melaninogenica* (GCA_000163035.1,
206 GCA_000759305.1, GCA_002208725.2, GCA_003609775.1, and GCF_000517825.1), *P.*
207 *nanceiensis* (GCA_000517825.1 and GCA_000613985.1), and *P. salivae* (GCA_000185845.1 and
208 GCA_902374235.1) using ART v2.3.7⁴¹.

209 Illumina reads for *P. histicola* T05-04T (SRR1518629) and *P. nanceiensis* ADL-403 (SRR755359)
210 were downloaded from the Sequence Read Archive database and quality filtered using Trimmomatic
211 v0.39⁴² parameters described elsewhere⁴³. The resulting biallelic, orthologous SNP matrix generated
212 by SPANDx was phylogenetically reconstructed using the maximum parsimony heuristic function of
213 PAUP* v4.0a (build 168). Phylogenies were visualised in FigTree; all trees were midpoint-rooted.

214 AMR determinant analysis. The Resistance Gene Identifier v5.1.1, which employs the Comprehensive
215 Antibiotic Resistance Database (CARD) v3.1.0⁴⁴, was used to identify putative AMR determinants.

216 Results and Discussion

217 Molecular typing approaches have been instrumental in unveiling previously untapped microbial
218 diversity in both healthy and diseased lungs. Using these techniques, *Prevotella* spp. have
219 consistently been identified as one of the most prevalent taxa in CF and COPD airways^{10,14,19}.
220 However, most studies to date have employed 16S metataxonomics (usually targeting the V3-V4
221 gene region), which only characterises *Prevotella* to the genus level, despite species and strain
222 resolution being fundamental to unravelling the role of these anaerobes in chronic lung disease. To
223 address this knowledge gap, our study used a combination of culture-dependent and -independent
224 methods to examine the genomic and phenotypic diversity, and prevalence, of *Prevotella* spp. present
225 in CF and COPD airways.

226 We first used a comparative genomics-guided approach to develop an accurate real-time PCR assay
227 to enable the rapid detection of *Prevotella* spp., to the exclusion of all other organisms, both from
228 cultures and clinical specimens. Our PCR assay was reasonably sensitive, with LoD and LoQ both
229 being 400fg/μL, or 111 genome equivalents (**Figure 1**). When tested against a diverse panel of 47
230 microbial and human DNA, the PCR demonstrated 100% specificity, amplifying all six tested
231 *Prevotella* species, but none of the non-*Prevotella* spp. DNA and 10 no-template controls. On clinical
232 specimens, the PCR identified *Prevotella* in 81% CF and 71% COPD participants, and in 81% CF and
233 66% COPD specimens (**Table 1**). This difference in detection rates between diseases was expected
234 given the generally lower total bacterial load in COPD airways¹. Metataxonomics had higher
235 *Prevotella* sensitivity than PCR, identifying *Prevotella* in six PCR-negative samples, although there
236 was one false-negative (SCHI0049.C.3, which was PCR- and culture-positive); there was otherwise
237 near-perfect correlation between PCR and metataxonomics (**Table S3**). In the six PCR-negative
238 samples, *Prevotella* relative abundance was very low (0.004-0.3%; median=0.05%), indicating that
239 DNA levels were below the PCR LoD threshold. Thus, culture-independent methods are highly
240 suitable for accurate *Prevotella* spp. detection from polymicrobial specimens, particularly real-time
241 PCR, which is often performed upon clinical sample receipt, thereby permitting same-day detection of
242 *Prevotella* in respiratory samples.

243 Culture of sputa and BWs onto three different agars (anaerobic blood medium containing nalidixic
244 acid and vancomycin, non-selective anaerobic blood medium, and PVCA) yielded a much lower
245 *Prevotella* positivity rate compared with PCR and metataxonomics. Only 44% CF and 28% COPD

246 clinical specimens, respectively, were *Prevotella*-positive via culture, compared with 81% and 66%
247 using PCR, and 84% and 91% using metataxonomics (**Table 1**). The reduced retrieval rate in COPD
248 vs. CF can be explained by lower relative *Prevotella* abundance according to metataxonomics (0.3-
249 74.3% [median=9.6%] for CF vs. 0.002%-36.4% [median=0.6%] for COPD). The lower prevalence of
250 *Prevotella* using culture is likely due to multiple factors, such as an inability of culture-independent
251 methods to distinguish viable from non-viable cells, nutritional fastidiousness, cells being in a viable
252 but non-culturable state, and outcompetition from faster-growing taxa^{9,19,22}. A prior study found that
253 four different culture media were required to recover 42 *Prevotella* isolates from 26 samples, and only
254 20 isolates were recoverable on more than one medium¹⁹. Moreover, all four media were required to
255 recover *P. melaninogenica* from all sputum samples¹⁹, suggesting that growth requirements may be
256 species- and strain-specific. In contrast to this prior work, we used aerobic collection and storage
257 conditions, which likely precluded recovery of *Prevotella* taxa with poor/no aerotolerance⁴⁵. Consistent
258 with their fastidiousness, one *P. histicola* and five *P. melaninogenica* initially isolated in our study
259 were unable to be resuscitated from glycerol stocks upon repeated attempts, despite previously being
260 culturable. Taken together, it is probable that several *Prevotella* species or strains were not recovered
261 by culture in our study due to multiple factors, thereby underestimating species and strain diversity
262 within our cohorts.

263 To gain greater insight into *Prevotella* residing in CF and COPD airways, we performed WGS and
264 phylogenetic analysis on cultured isolates to determine species identity and strain relatedness. From
265 36 CF sputa, 27 PCR-positive *Prevotella* colonies were retrieved, of which 18 were *Prevotella* spp.;
266 the remaining nine contained a mixture of *Prevotella* and other taxa, or a mixture of multiple
267 *Prevotella* spp., due to insufficient subculturing for purity prior to WGS (**Table S3**). To avoid known
268 bioinformatic analysis issues associated with variant calling from mixtures⁴⁶, these mixed data were
269 excluded from phylogenetic analysis. Among the 18 isolates, WGS identified seven *Prevotella* spp.: *P.*
270 *histicola* ($n=5$), *P. melaninogenica* ($n=5$), *P. denticola* ($n=3$), *P. nanceiensis* ($n=2$), *P. jejuni* ($n=1$), *P.*
271 *nigrescens* ($n=1$), and *P. salivae* ($n=1$). Of the 17 COPD-derived isolates, none were mixed due to a
272 greater number of passages carried out to obtain purity. WGS identified six *Prevotella* spp.: *P.*
273 *melaninogenica* ($n=8$), *P. histicola* ($n=3$), *P. salivae* ($n=3$), *P. buccae* ($n=1$), *P. denticola* ($n=1$), and *P.*
274 *nanceiensis* ($n=1$) (**Table S3**). Despite being fundamentally different diseases, there was little
275 difference in *Prevotella* species found in CF and COPD, with only *P. jejuni* and *P. nigrescens* being

276 unique to CF, and *P. buccae* being unique to COPD. One explanation for this overlap is that the oral
277 cavity and oropharynx are common habitats for all retrieved species, except *P. jejuni*⁴⁷; it is thus
278 possible that some strains we isolated were upper airway residents. Whilst oral cavity contamination
279 is unavoidable during respiratory secretion collection, especially for sputum, microbes can also enter
280 lower airways via small-volume oral cavity aspirations; indeed, the risk of microbial colonisation and
281 persistence is greatly increased in mucociliary-impaired CF and COPD airways^{24,48-52}. In support of
282 lower airway origin, we identified *Prevotella* spp. in both sputa and BWs. Unlike sputa, BWs are
283 collected via bronchoscopy and thus far less prone to oral/oropharynx contamination, providing
284 greater confidence that many of our retrieved *Prevotella* isolates originated from the lower airways.

285 The origin of *P. jejuni* in one CF participant is somewhat perplexing. This species was first
286 documented in the small intestine of a child with coeliac disease in 2012⁵³, and little is currently
287 known about the distribution of this organism in healthy and diseased niches. One possibility is that *P.*
288 *jejuni* entered the CF airways via inhalation of gastroesophageal aspirations. Alternatively, microbial
289 inter-compartment cross-talk between the lungs and gut (the 'Gut-Lung axis') via the mesenteric
290 lymphatic system may explain its presence in the lungs⁵⁴. As a relatively new taxon, little is known
291 about possible mechanisms of *P. jejuni* pathogenesis, with more work needed to determine the
292 prevalence and virulence potential of this bacterium in both healthy and diseased airways.

293 The most frequently isolated species in our study – *P. melaninogenica* (37%), *P. histicola* (23%), *P.*
294 *salivae* (11%), *P. denticola* (11%), and *P. nanceiensis* (9%) – are common in CF^{14,15,19} and COPD²⁵
295 airways. However, their precise role in airway disease is poorly understood due to conflicting reports
296 about their beneficial vs. pathogenic potential. For instance, *P. melaninogenica*, *P. salivae*, and *P.*
297 *nanceiensis* may inhibit non-typeable *Haemophilus influenzae*-induced pro-inflammatory cytokine
298 production by lung dendritic cells⁵², increased *P. melaninogenica* prevalence in CF airways has been
299 associated with improved lung function¹⁵, and *P. histicola* can mute pro-inflammatory pathways
300 triggered by *P. aeruginosa* in CF airways⁵⁵. In contrast, *P. melaninogenica* produced the greatest
301 variety of short-chain fatty acids (associated with inflammation) amongst five tested anaerobes¹⁸, and
302 *P. denticola* shares similarities in its lipid A moieties to *P. intermedia* (a known pathogenic species),
303 pointing towards pro-inflammatory traits⁵⁶. Finally, certain strains of the periodontal disease-
304 associated species, *P. nigrescens*, a close relative of *P. intermedia*, are thought to encode an
305 enzymatic cell hydrolysis mechanism that destroys tissues. Given the reported conflicting roles of

306 *Prevotella* spp. in chronic lung disease, these collective results suggest that virulence mechanisms
307 vary among *Prevotella* strains, which requires further exploration^{57,58}. Our genomic data will assist
308 these future efforts.

309 In our experience, metagenomic analysis tools can struggle with *Prevotella* species-level identification
310 from respiratory specimens due to a lack of accurate representative species in public databases.
311 Exemplifying this problem, few publicly available genomic data are available for *P. nanceiensis* – only
312 three were available at the time this study was undertaken, one of which is misclassified as *P.*
313 *melaninogenica*, and another as *Prevotella* sp. (**Figure 3**). Thus, our addition of three *P. nanceiensis*
314 genomes doubles the available *P. nanceiensis* data. Similarly, there are currently only a handful of
315 nonredundant *P. jejuni* genomes in public databases, and none are from lower airway specimens; our
316 addition *P. jejuni* SCHI0011.S.13 genome is therefore valuable for future respiratory and
317 gastroenterological studies. Taken together, our *P. nanceiensis* and *P. jejuni* genomes will help public
318 database curation efforts, and in turn, improve species identification using metagenomics.

319 To determine strain relatedness within and between participant airways, we undertook within-species
320 analyses of our *P. denticola*, *P. histicola*, *P. melaninogenica*, *P. nanceiensis* and *P. salivae* genomes
321 (**Figure 3**). Whole-genome SNP analysis revealed high levels of strain and interhost diversity in all
322 examined *Prevotella* species. For example, genetic variation was as high as ~72k SNPs among *P.*
323 *histicola* strains, an impressive feat for an organism encoding a 3Mbp genome, and *P. nanceiensis*
324 strains SCHI0010.S.3 and SCHI0011.S.12 were more closely related to strains isolated from France
325 and the US, respectively, than to other strains retrieved from other Australian participants. In contrast,
326 intrahost diversity was relatively limited (0-297 SNPs), with two instances of genetically
327 indistinguishable strains: *P. histicola* SCHI0034.S.5 and SCHI0034.S.6, and *P. melaninogenica*
328 SCHI0034.S.7 and SCHI0034.S.9 (**Figure 3**); the latter pair were retrieved from a BW and sputum
329 collected on the same day (**Table S1**; **Table S3**). The only exception was *P. melaninogenica* from
330 SCHI0027, where two genetically distinct lineages separated by >20k SNPs were retrieved from this
331 participant. There was no evidence of genetically-related strains between any of the Australian
332 participants for any *Prevotella* spp. (**Figure 3**). These findings indicate that interhost diversity is very
333 high, whereas within-host *Prevotella* diversity is limited, possibly due to frequent microaspiration of
334 *Prevotella* from upper to lower airways (or via the gut-lung axis) rather than chronic infection;
335 however, more in-depth sampling is required to investigate *Prevotella* persistence.

336 Antibiotics are routinely used in the maintenance and treatment of acute respiratory infections in CF
337 and COPD^{15,59}. Given its uncertain pathogenic role, *Prevotella* spp. are not targeted by these
338 treatment regimens⁶⁰. Despite this, AMR rates in *Prevotella* are trending upwards⁵⁹, possibly due to
339 bystander selection. To examine this phenomenon, we determined AMR profiles for all culturable
340 *Prevotella* strains ($n=27$) using disc diffusion against 11 antibiotics commonly used to treat lung
341 infections^{15,59}, or which have known activity against anaerobic taxa⁴⁷. AMR (AZM, CAZ, CLI, MZ,
342 TOB) or reduced susceptibility (AMC, AZM, CAZ, DOX, MEM) was observed in at least one strain,
343 whereas all were susceptible towards CHL, TZP, and IPM, an observation supported by previous
344 studies^{47,59,61}. Reflecting much greater lifetime antimicrobial use in the CF cohort⁶², the 18 tested CF
345 strains had much higher AMR incidence (57% vs. 8%) and AMR gene presence (83% vs. 35%)
346 compared with COPD strains, and this rate increased to 100% (69% for COPD) when including
347 strains with reduced susceptibility towards one or more antibiotics (**Table 2**). In addition, almost all CF
348 participants were undergoing antimicrobial treatment with at least two different antibiotic classes at
349 the time of sample collection, vs. almost no antibiotic use in the COPD participants (**Table S1**). One
350 strain, CF isolate *P. histicola* SCHI0009.S.6, could be classed as multidrug-resistant due to exhibiting
351 AMR towards three antibiotic classes⁶³ – β -lactams, lincosamides, and imidazoles – along with
352 reduced susceptibility towards the tetracycline-class antibiotic, DOX (**Table 2**). Our findings confirm
353 bystander AMR selection in off-target *Prevotella* as a direct result of heavy antimicrobial use in CF
354 (and to a much lesser extent, COPD), which may have ramifications for *Prevotella* persistence as a
355 potential driver of disease pathogenesis.

356 TOB was the only antibiotic tested that showed AMR in all tested isolates, including the type strain, *P.*
357 *melaninogenica* LMG 28911 (**Table 2**). This finding that concurs with prior work reporting 100% TOB
358 resistance among 157 *Prevotella* isolates⁵⁹. A CF microbiome study also found that *Prevotella*
359 abundance was largely unchanged upon TOB treatment⁶⁴. These collective findings indicate that all
360 respiratory *Prevotella* species are intrinsically resistant to TOB. Notably, we observed that the median
361 relative *Prevotella* abundance according to metataxonomics was quite different between CF (9.6%)
362 vs. COPD (0.6%) specimens (**Table S3**). Although the basis of this higher relative *Prevotella*
363 abundance in CF is unknown, one possibility is that most of our CF participants were receiving TOB
364 at the time of sample collection (**Table S1**; **Table 2**), whereas no COPD participant was receiving this
365 antibiotic. The predominance of *Prevotella* spp. in the CF airways might thus be attributed to much

366 more frequent TOB use in this cohort⁶⁵⁻⁶⁷. Although not assessed in this study, adding TOB to
367 selective media may improve *Prevotella* recovery rates from respiratory specimens by suppressing
368 growth of other taxa. After TOB, CLI resistance was most common (6/14 CF isolates), followed by
369 AZM (4/14 CF isolates), MZ (1/13 COPD and 3/14 CF isolates), and CAZ (2/14 CF isolates).
370 Decreased susceptibility towards AMC, CAZ, and DOX was common in both CF and COPD isolates;
371 however, only CF isolates exhibited decreased AZM susceptibility (6/14 isolates). These results
372 provide further evidence of bystander selection in *Prevotella* spp., with this effect especially noticeable
373 in CF-derived isolates.

374 AMR genes represent a major concern in infection control as these genes can rapidly transfer AMR
375 among different genera and species. To determine AMR gene potential, CARD analysis was
376 performed on the 35 CF-COPD *Prevotella* genomes and used to correlate horizontally acquired AMR-
377 conferring genes with AMR/decreased susceptibility phenotypes. Consistent with their higher AMR
378 rates, CF isolates demonstrated greater prevalence of AMR-conferring genes compared with COPD
379 (**Table 2**). Strikingly, 67% CF strains encoded *ermF*, a horizontally-acquired gene that confers
380 resistance towards macrolide, lincosamide, and streptogramin-class antibiotics such as AZM and
381 CLI^{47,61,68}. In contrast, *ermF* was absent in all COPD strains, a somewhat unexpected finding given
382 that COPD participants are frequently given long-term macrolides (e.g. azithromycin, erythromycin) as
383 prophylaxis to reduce exacerbation frequency⁶⁹. None of the CF or COPD participants were receiving
384 these antibiotics at the time of sample collection, suggesting that cross-resistance or prior CF
385 antibiotic treatment may be driving *ermF* acquisition and maintenance in *Prevotella*. *ermF* presence
386 correlated well with AZM and CLI AMR/decreased susceptibility (87% and 75%, respectively). *ermF*
387 rates in our Australian isolates exceed those previously reported (23-68% in UK, USA, and Italian
388 isolates from both healthy and diseased participants)^{68,70}. This discrepancy is likely due to only
389 respiratory disease-associated isolates being tested in our study, but may also be due to differences
390 in AMR cut-offs between studies, *in vivo* antibiotic exposure levels, and potentially species or strain
391 composition, noting that one study only identified most isolates to the genus level⁶⁸.

392 *tetQ*, which confers resistance to tetracycline-class antibiotics (e.g. DOX)^{68,70}, was present in 54% of
393 our strains, and more common in CF-derived strains (67% vs. 41%). This rate is much higher than
394 *tetQ* prevalence reported in UK CF (21%)⁶⁸ and human-derived Dutch (30%)⁶¹ strains. . Our *tetQ*-
395 harbouring strains consistently showed much smaller DOX disc diameters (12-30mm; median 22mm)

396 compared with *tetQ*-negative strains (40-64mm; median 54mm) with 100% correlation between *tetQ*
397 presence and decreased DOX susceptibility (**Table 2**). A prior study reported that 83% of *tetQ*-
398 positive isolates demonstrated intermediate or full resistance towards tetracycline⁶⁸, suggesting that
399 *tetQ* is a reliable marker of reduced susceptibility towards tetracycline-class antibiotics. Taken
400 together, these results confirm that *tetQ* presence robustly confers decreased DOX susceptibility in
401 *Prevotella* spp. Although our dataset is small, we propose *Prevotella* spp. DOX disc diameters of
402 ≥ 40 mm to denote strains lacking *tetQ*, and ≤ 30 mm to denote strains that may be harbouring *tetQ*, with
403 the caveat that other enigmatic determinants conferring reduced DOX susceptibility (e.g.
404 chromosomal mutations) may be present in lieu of *tetQ*. These criteria also differentiate *Prevotella*
405 spp. exhibiting decreased DOX susceptibility from DOX-sensitive strains.

406 The *cfxA*-type β -lactamase gene is the most clinically important AMR mechanism in *Prevotella* spp.⁷¹
407 as it confers AMR towards cephamycins⁶¹ and some other β -lactam antibiotics⁶⁸, which are commonly
408 used in respiratory infection treatment⁵⁹. Concerningly, *cfxA* is often encoded on mobile elements,
409 meaning that AMR can potentially be transmitted from *Prevotella* spp. to known pathogenic taxa in the
410 respiratory microbiome⁷². We found *cfxA* alleles 2, 3, 4, and/or 5 in 54% strains (72% CF and 35%
411 COPD). *cfxA3* and *cfxA2* were most common, being present in 37% and 14% strains, respectively. In
412 comparison, a study of UK and US isolates reported much higher *cfxA* carriage rates (86%), with 29%
413 and 52% strains encoding *cfxA3* and *cfxA2*, respectively. Their study also found that *cfxA3*-encoding
414 isolates exhibited significantly higher CAZ resistance levels⁶⁸, which we also observed in our *cfxA3*-
415 harbouring strains (median disc diameter=12mm vs. 32mm in non-*cfxA3* strains) (**Table 2**). In *cfxA3*-
416 encoding strains displaying CAZ sensitivity, reduced *cfxA3* expression⁷³ may explain this phenotype,
417 although this was not explored in our study. In addition, we did not test *Prevotella* susceptibility
418 towards cephamycins so were unable to determine whether *cfxA* variants correlated with these β -
419 lactam antibiotics.

420 MZ resistance was evident in 4/28 tested strains (3 CF; 1 COPD), despite none of the participants
421 receiving nitroimidazoles at the time of sample collection. Other than TOB, MZ was the only antibiotic
422 that exhibited AMR in any of the COPD strains. The *nim* genes, which encode for nitroimidazole
423 reductase enzymes and have previously been associated with MZ resistance in *P. baroniae*⁷⁴ and *P.*
424 *bivia*⁷⁵, were not detected in any isolate. Therefore, the basis of MZ resistance in our isolates remains
425 unknown.

426 Of the eight species identified in our study, four are conventionally considered dark-pigmented – *P.*
427 *denticola*, *P. histicola*, *P. melaninogenica*, and *P. nigrescens*. Pigmented *Prevotella* reportedly
428 harbour a greater cache of virulence factors and are more commonly associated with infection⁴⁷.
429 However, we found limited phenotypic differences within and between species on non-selective
430 anaerobic blood medium at Day 3 (**Figure 4**), with most presenting as convex, shiny, white colonies;
431 only *P. nigrescens* demonstrated tan pigmentation in the primary streak at this time point (**Figure 4F**).
432 In contrast, a dark brown to black pigment was produced by *P. nigrescens* on PVCA by Day 3 (**Figure**
433 **5D**), but not on selective or non-selective anaerobic media, even by Day 10, with only medium-brown
434 colonies present (**Figure 5B and 5C**). *P. histicola* demonstrated tan-coloured pigmentation on both
435 non-selective anaerobic medium and PVCA, but only after five days (**Figure 6**), and unlike *P.*
436 *nigrescens*, did not develop black pigment on PVCA at Days 5 or 10. *P. melaninogenica* reportedly
437 produces a characteristic dark pigment that is commonly associated with the species^{76,77}; yet, no
438 pigmentation was observed in the six *P. melaninogenica* isolates on any medium by Day 10. A likely
439 explanation for this phenomenon is that different strains require different media for pigment
440 production⁷⁸. Collectively, the limited pigmentation observed among *Prevotella* spp. suggests that
441 phenotypic characteristics alone should not be used for *Prevotella* genus or species identification.

442 We acknowledge several study limitations. First, small sample size (43 enrolled participants; 69
443 samples) and inclusion of only COPD and CF samples makes it difficult to generalise our results
444 across a larger cohorts. Nevertheless, the broad agreement of our findings with previous
445 literature^{10,14,19} demonstrates a reasonable estimation of species diversity in these cohorts. Second,
446 due to non-anaerobic sample handling and storage, non-aerotolerant *Prevotella* species may have
447 been rendered non-viable and thus not recoverable⁴⁵. Future establishment of disc diffusion
448 guidelines in *Prevotella* will enable more accurate assessment of AMR phenotypes in this genus.

449 Third, due to our use of a strict AMR cut-off (i.e. 6mm), AMR rates in our *Prevotella* are almost
450 certainly underestimated. Fourth, we did not assess healthy airway microbiota due to difficulties
451 associated with obtaining respiratory secretions from healthy participants. Future work should
452 continue to seek strain-level resolution of *Prevotella* strains in CF and COPD airways, including the
453 design of species-specific assays towards commonly isolated and known pathogenic species,
454 assessment of *Prevotella* from healthy airways, and incorporation of higher-resolution molecular
455 technologies such as metagenomics and metatranscriptomics to gain a clearer understanding of

456 *Prevotella* function within complex microbiomes. Co-culture experiments between *Prevotella* species
457 and known respiratory pathogens, such as *P. aeruginosa*, would be beneficial for elucidating the role
458 of *Prevotella* in potentiating or abrogating pathogen virulence. Finally, phylogeographic analysis of
459 *Prevotella* genomes may permit a deeper understanding of *Prevotella* spp. distribution and strain
460 diversity in chronic lung disease globally, and population genomic approaches will yield a better
461 understanding of *Prevotella* origin and capacity for airway-to-airway transmission.

462 **Acknowledgements**

463 We thank Tamiaka Fraser (University of the Sunshine Coast) for laboratory assistance, Peter Timms
464 (University of the Sunshine Coast) and Laura Sherrard (Queen's University Belfast) for insightful
465 feedback on this manuscript, Tania Duarte (University of Queensland) for helpful discussions about
466 the challenges of *Prevotella* identification using current metagenomic pipelines, and the Belgian Co-
467 ordinated Collection of Micro-organisms (BCCM) for providing type strains. This work was funded by
468 Advance Queensland (awards AQR13016-17RD2 and AQIRF0362018), the Wishlist Sunshine
469 Coast Hospital Foundation (award 2019-24), and the University of the Sunshine Coast. The authors
470 declare no conflicts of interest.

471 **Figure legends**

472

473 **Figure 1.** Limits of detection (LoD) and quantification (LoQ) for the *Prevotella* real-time PCR assay.

474 The LoQ and LoD were both 400fg/μL according to previously defined parameters³⁵, or 111 genome
475 equivalents.

476 **Figure 2.** Full-length 16S ribosomal RNA gene phylogenetic analysis of the 35 *Prevotella* strains

477 retrieved in this study (identified by 'SCHI' prefix) against 199 non-redundant public *Prevotella*

478 genomes comprising 56 taxa of known species and 40 taxa of unassigned species. Species clades

479 containing isolates identified from our cystic fibrosis (CF) and chronic obstructive pulmonary disease

480 (COPD) specimens are coloured.

481 **Figure 3. Maximum parsimony within-species phylogenomic reconstruction of *P. denticola*, *P.***

482 ***histicola*, *P. melaninogenica*, *P. nanceiensis* and *P. salivae*.** Strains identified from COPD and CF

483 specimens from this study are labelled with the 'SCHI' prefix; the remaining strains are public

484 genomes. The number of SNPs separating each strain is labelled on branches; where two or more

485 strains were retrieved from a single participant, coloured branch labels represent the number of SNPs

486 separating these strains. CI, consistency index. Incorrectly speciated public genomes are denoted by

487 an asterisk.

488 **Figure 4.** Three-day growth of *Prevotella* spp. on non-selective anaerobic blood medium. (A) *P.*

489 *melaninogenica*; (B) *P. histicola*; (C) *P. denticola*; (D) *P. nanceiensis*; (E) *P. jejuni*; (F) *P. nigrescens*;

490 (G) *P. salivae*; and (H) *P. buccae*.

491 **Figure 5.** Phenotype comparison of *Prevotella nigrescens* on non-selective anaerobic blood medium

492 (top) and polyvitaminic-supplemented chocolate agar (bottom) at (A and D) 3 days; (B and E) 5 days;

493 and (C and F) 10 days.

494 **Figure 6.** Phenotype comparison of *Prevotella histicola* on non-selective anaerobic blood medium

495 (top) and polyvitaminic-supplemented chocolate agar (bottom) at (A and C) 3 days and (B and D) 5

496 days.

497 **Tables**

498 **Table 1.** *Prevotella* spp. prevalence in cystic fibrosis (CF) and chronic obstructive pulmonary disease
499 (COPD) according to microbiological culture, real-time PCR, and 16S rRNA gene metataxonomics.

<i>Prevotella</i> +ve		CF	COPD
Participants	Culture	11/21 (52%)	6/21 (29%)
	PCR	17/21 (81%)	15/21 (71%)
	Metataxonomics	15/17 (88%)	16/18 (89%)
Specimens	Culture	16/36 (44%)	9/32 (28%)
	PCR	29/36 (81%)	21/32 (66%)
	Metataxonomics	26/31 (84%)	20/22 (91%)

500

501 **Table 2.** Disc diffusion and antimicrobial resistance gene results for genome-sequenced *Prevotella* isolates from cystic fibrosis (CF) or chronic obstructive
 502 pulmonary disease (COPD) respiratory secretions, and antibiotic treatment at time of isolate collection.

Strain ID	<i>Prevotella</i> sp. [‡]	Antibiotic disc diffusion diameter (mm) by antibiotic class											<i>cfxA</i> allele	Antibiotic treatment [†]
		Macrolide-lincosamides		Tetra-cyclines	Other			β-lactams						
		AZM	CLI	DOX	CHL	MZ	TOB	AMC	CAZ	TZP	IPM	MEM		
<i>CF-derived isolates</i>														
SCHI0006.S.13	<i>P. histicola</i>	50	60	24*	42	50	6	70	52	64	60	58	Neg	Nil
SCHI0009.S.5	<i>P. melaninogenica</i>	6 [†]	6 [†]	22*	34	38	6	30	30	50	60	46	Neg	FOF, TOB
SCHI0009.S.6	<i>P. histicola</i>	6 [†]	6 [†]	16*	32	6	6	50	40	48	60	44	Neg	FOF, TOB
SCHI0010.S.3	<i>P. nanceiensis</i>	nt [†]	nt [†]	nt*	nt	nt	nt	nt	nt	nt	nt	nt	<i>cfxA3</i>	CAZ, TOB
SCHI0011.S.12	<i>P. nanceiensis</i>	32	40	14*	34	6	6	20	6	44	56	46	<i>cfxA3</i>	CAZ, TOB
SCHI0011.S.13	<i>P. jejuni</i>	46	48	20*	34	46	6	34	32	52	62	40	Neg	CAZ, TOB
SCHI0018.S.9	<i>P. salivae</i>	nt [†]	nt [†]	nt*	nt	nt	nt	nt	nt	nt	nt	nt	<i>cfxA3</i>	CAZ, TZP, TOB
SCHI0021.S.9	<i>P. denticola</i>	6 [†]	6 [†]	24*	34	58	6	24	10	46	54	44	<i>cfxA4</i>	CAZ, TOB
SCHI0027.S.6	<i>P. melaninogenica</i>	26	52	44	32	42	6	24	14	42	54	46	Neg	CAZ, TOB
SCHI0027.S.7	<i>P. histicola</i>	6 [†]	6 [†]	50	34	40	6	14	10	48	50	46	<i>cfxA3</i>	CAZ, TOB
SCHI0027.S.9	<i>P. melaninogenica</i>	42 [†]	34 [†]	40	44	6	6	48	40	52	64	50	<i>cfxA3</i>	CAZ, TOB
SCHI0027.S.11	<i>P. melaninogenica</i>	nt [†]	nt [†]	nt	nt	nt	nt	nt	nt	nt	nt	nt	<i>cfxA3</i>	CAZ, TOB
SCHI0027.S.12	<i>P. denticola</i>	8 [†]	6 [†]	20*	34	44	6	10	6	38	46	38	<i>cfxA3</i>	CAZ, TOB
SCHI0027.S.13	<i>P. melaninogenica</i>	nt [†]	nt [†]	nt	nt	nt	nt	nt	nt	nt	nt	nt	<i>cfxA3</i>	CAZ, TOB
SCHI0027.S.14	<i>P. denticola</i>	14 [†]	6 [†]	56	42	50	6	14	8	48	48	40	<i>cfxA3</i>	CAZ, TOB
SCHI0028.S.1	<i>P. histicola</i>	18	54	14*	38	40	6	50	32	44	60	26	<i>cfxA2</i>	MEM, TOB
SCHI0028.S.4	<i>P. histicola</i>	20	64	24*	48	44	6	26	34	56	62	40	<i>cfxA2</i>	MEM, TOB
SCHI0028.S.5	<i>P. nigrescens</i>	10 [†]	50 [†]	30*	50	60	6	36	24	50	56	50	<i>cfxA2</i>	MEM, TOB
<i>COPD-derived isolates</i>														
SCHI0034.S.5	<i>P. histicola</i>	52	70	64	50	60	6	66	58	66	60	50	Neg	Nil
SCHI0034.S.6	<i>P. histicola</i>	44	60	58	42	50	6	58	50	58	58	50	Neg	Nil
SCHI0034.S.7	<i>P. melaninogenica</i>	40	48	12*	34	38	6	48	20	46	52	54	<i>cfxA3</i>	Nil
SCHI0034.S.8	<i>P. salivae</i>	38	54	20*	36	46	6	50	20	50	54	48	Neg	Nil
SCHI0034.S.9	<i>P. melaninogenica</i>	nt	nt	nt	nt	nt	nt	nt	nt	nt	nt	nt	<i>cfxA3</i>	Nil
SCHI0034.S.10	<i>P. histicola</i>	nt	nt	nt	nt	nt	nt	nt	nt	nt	nt	nt	Neg	Nil
SCHI0034.S.11	<i>P. salivae</i>	46	50	20*	36	44	6	48	26	48	52	52	Neg	Nil
SCHI0042.S.4	<i>P. denticola</i>	38	46	24*	36	46	6	18	14	44	50	42	<i>cfxA2</i>	AMX

													<i>cfxA5</i>	
SCHI0042.S.5	<i>P. nanceiensis</i>	30	36	26*	34	6	6	14	12	36	52	52	<i>cfxA3</i>	AMX
SCHI0043.S.1	<i>P. melaninogenica</i>	nt	nt	nt	nt	nt	nt	nt	nt	nt	nt	nt	Neg	Nil
SCHI0043.S.2	<i>P. melaninogenica</i>	nt	nt	nt	nt	nt	nt	nt	nt	nt	nt	nt	Neg	Nil
SCHI0043.S.3	<i>P. melaninogenica</i>	36	44	54	36	48	6	50	34	50	58	50	Neg	Nil
SCHI0044.S.1	<i>P. melaninogenica</i>	34	56	60	42	48	6	30	24	56	58	52	Neg	Nil
SCHI0047.S.2	<i>P. melaninogenica</i>	40	48	24*	32	48	6	18	12	50	50	46	<i>cfxA2</i>	Nil
SCHI0047.S.3	<i>P. salivae</i>	40	48	24*	32	48	6	18	12	50	50	46	Neg	Nil
SCHI0047.S.4	<i>P. buccae</i>	46	58	54	42	52	6	52	38	58	56	50	Neg	Nil
SCHI0049.S.1	<i>P. melaninogenica</i>	44	58	58	44	50	6	24	20	58	60	52	<i>cfxA3</i>	Nil
LMG 28911 (type strain)	<i>P. melaninogenica</i>	40	54	50	36	46	6	50	50	54	52	38	Unknown	Unknown

503 Abbreviations: AMC, amoxicillin-clavulanate; AMX, amoxicillin; AZM, azithromycin; CAZ, ceftazidime; CHL, chloramphenicol; CLI, clindamycin; DOX,
 504 doxycycline; FOF, fosfomicin; IPM, imipenem; MEM, meropenem; MZ, metronidazole; Neg, negative; nt, not tested for antimicrobial sensitivity; TZP,
 505 piperacillin-tazobactam; TOB, tobramycin
 506 Dark grey-shaded cells represent definitive antimicrobial resistance (i.e. growth right up to the disc), light grey-shaded cells reflect reduced susceptibility
 507 (≤ 30 mm diameter), and unshaded cells represent probable sensitivity (> 30 mm diameter)
 508 †Encodes *ermF*, which confers resistance towards erythromycin⁷⁰
 509 ‡At time of clinical specimen collection from which the isolate was derived
 510 *Encodes *tetQ*, which is associated with decreased susceptibility/resistance towards tetracycline-class antibiotics^{68,70} such as DOX
 511 †As determined from whole-genome sequence analysis

512 References

- 513 1. Sze MA, Hogg JC, Sin DD. Bacterial microbiome of lungs in COPD. *Int J Chron Obstruct Pulmon Dis*
514 2014; **9**: 229-38.
- 515 2. Fenker DE, McDaniel CT, Panmanee W, et al. A comparison between two pathophysiologically different
516 yet microbiologically similar lung diseases: cystic fibrosis and chronic obstructive pulmonary disease. *Int J Respir*
517 *Pulm Med* 2018; **5**(2).
- 518 3. Wedzicha JA, Seemungal TA. COPD exacerbations: defining their cause and prevention. *Lancet* 2007;
519 **370**(9589): 786-96.
- 520 4. Lyczak JB, Cannon CL, Pier GB. Lung infections associated with cystic fibrosis. *Clin Microbiol Rev*
521 2002; **15**(2): 194-222.
- 522 5. Jacobs DM, Pandit U, Sethi S. Acute exacerbations in chronic obstructive pulmonary disease: should
523 we use antibiotics and if so, which ones? *Curr Opin Infect Dis* 2019; **32**(2): 143-51.
- 524 6. Larsen JM. The immune response to *Prevotella* bacteria in chronic inflammatory disease. *Immunology*
525 2017; **151**(4): 363-74.
- 526 7. Gilpin DF, Nixon KA, Bull M, et al. Evidence of persistence of *Prevotella* spp. in the cystic fibrosis lung. *J*
527 *Med Microbiol* 2017; **66**(6): 825-32.
- 528 8. Ditz B, Christenson S, Rossen J, et al. Sputum microbiome profiling in COPD: beyond singular
529 pathogen detection. *Thorax* 2020; **75**(4): 338-44.
- 530 9. Pattison SH, Rogers GB, Crockard M, Elborn JS, Tunney MM. Molecular detection of CF lung
531 pathogens: current status and future potential. *J Cyst Fibros* 2013; **12**(3): 194-205.
- 532 10. Lee SW, Kuan CS, Wu LS, Weng JT. Metagenome and metatranscriptome profiling of moderate and
533 severe COPD sputum in Taiwanese Han males. *PLoS One* 2016; **11**(7): e0159066.
- 534 11. Muhlebach MS, Hatch JE, Einarsson GG, et al. Anaerobic bacteria cultured from cystic fibrosis airways
535 correlate to milder disease: a multisite study. *Eur Respir J* 2018; **52**(1).
- 536 12. Amat S, Lantz H, Munyaka PM, Willing BP. *Prevotella* in pigs: the positive and negative associations
537 with production and health. *Microorganisms* 2020; **8**(10).
- 538 13. Wybo I, Soetens O, De Bel A, et al. Species identification of clinical *Prevotella* isolates by matrix-
539 assisted laser desorption ionization-time of flight mass spectrometry. *J Clin Microbiol* 2012; **50**(4): 1415-8.
- 540 14. Tunney MM, Field TR, Moriarty TF, et al. Detection of anaerobic bacteria in high numbers in sputum
541 from patients with cystic fibrosis. *Am J Respir Crit Care Med* 2008; **177**(9): 995-1001.
- 542 15. Cuthbertson L, Walker AW, Oliver AE, et al. Lung function and microbiota diversity in cystic fibrosis.
543 *Microbiome* 2020; **8**(1): 45.
- 544 16. Han MK, Huang YJ, Lipuma JJ, et al. Significance of the microbiome in obstructive lung disease. *Thorax*
545 2012; **67**(5): 456-63.
- 546 17. Wang Z, Maschera B, Lea S, et al. Airway host-microbiome interactions in chronic obstructive
547 pulmonary disease. *Respir Res* 2019; **20**(1): 113.
- 548 18. Mirkovic B, Murray MA, Lavelle GM, et al. The role of short-chain fatty acids, produced by anaerobic
549 bacteria, in the cystic fibrosis airway. *Am J Respir Crit Care Med* 2015; **192**(11): 1314-24.
- 550 19. Field TR, Sibley CD, Parkins MD, Rabin HR, Surette MG. The genus *Prevotella* in cystic fibrosis
551 airways. *Anaerobe* 2010; **16**(4): 337-44.
- 552 20. Ulrich M, Beer I, Braitmaier P, et al. Relative contribution of *Prevotella intermedia* and *Pseudomonas*
553 *aeruginosa* to lung pathology in airways of patients with cystic fibrosis. *Thorax* 2010; **65**(11): 978-84.
- 554 21. Jorth P, Ehsan Z, Rezayat A, et al. Direct lung sampling indicates that established pathogens dominate
555 early infections in children with cystic fibrosis. *Cell Rep* 2019; **27**(4): 1190-204.
- 556 22. Zemanick ET, Wagner BD, Sagel SD, Stevens MJ, Accurso FJ, Harris JK. Reliability of quantitative real-
557 time PCR for bacterial detection in cystic fibrosis airway specimens. *PLoS One* 2010; **5**(11): e15101.
- 558 23. O'Neill K, Bradley JM, Johnston E, et al. Reduced bacterial colony count of anaerobic bacteria is
559 associated with a worsening in lung clearance index and inflammation in cystic fibrosis. *PLoS One* 2015; **10**(5):
560 e0126980.
- 561 24. Einarsson GG, Zhao J, LiPuma JJ, Downey DG, Tunney MM, Elborn JS. Community analysis and co-
562 occurrence patterns in airway microbial communities during health and disease. *ERJ Open Res* 2019; **5**(3).
- 563 25. Wang Z, Liu H, Wang F, et al. A refined view of airway microbiome in chronic obstructive pulmonary
564 disease at species and strain-levels. *Front Microbiol* 2020; **11**: 1758.
- 565 26. Human Microbiome Jumpstart Reference Strains Consortium. A catalog of reference genomes from the
566 human microbiome. *Science* 2010; **328**(5981): 994-9.
- 567 27. Gupta VK, Chaudhari NM, Iskepalli S, Dutta C. Divergences in gene repertoire among the reference
568 *Prevotella* genomes derived from distinct body sites of human. *BMC Genomics* 2015; **16**: 153.
- 569 28. Zhang Y, Zhen M, Zhan Y, Song Y, Zhang Q, Wang J. Population-genomic insights into variation in
570 *Prevotella intermedia* and *Prevotella nigrescens* isolates and its association with periodontal disease. *Front Cell*
571 *Infect Microbiol* 2017; **7**: 409.
- 572 29. Tett A, Huang KD, Asnicar F, et al. The *Prevotella copri* complex comprises four distinct clades
573 underrepresented in Westernized populations. *Cell Host Microbe* 2019; **26**(5): 666-79.
- 574 30. de Lamballerie X, Zandotti C, Vignoli C, Bollet C, de Micco P. A one-step microbial DNA extraction
575 method using "Chelex 100" suitable for gene amplification. *Res Microbiol* 1992; **143**(8): 785-90.

- 576 31. Triant DA, Whitehead A. Simultaneous extraction of high-quality RNA and DNA from small tissue
577 samples. *J Hered* 2009; **100**(2): 246-50.
- 578 32. Altschul SF, Gish W, Miller W, Myers EW, Lipman DJ. Basic local alignment search tool. *J Mol Biol*
579 1990; **215**(3): 403-10.
- 580 33. Klaassen CH, Jeunink MA, Prinsen CF, et al. Quantification of human DNA in feces as a diagnostic test
581 for the presence of colorectal cancer. *Clin Chem* 2003; **49**(7): 1185-7.
- 582 34. Nadkarni MA, Martin FE, Jacques NA, Hunter N. Determination of bacterial load by real-time PCR using
583 a broad-range (universal) probe and primers set. *Microbiology (Reading)* 2002; **148**(Pt 1): 257-66.
- 584 35. Price EP, Dale JL, Cook JM, et al. Development and validation of *Burkholderia pseudomallei*-specific
585 real-time PCR assays for clinical, environmental or forensic detection applications. *PLoS One* 2012; **7**(5):
586 e37723.
- 587 36. Hudzicki J. Kirby-Bauer Disk Diffusion Susceptibility Test Protocol. 2016.
588 <https://asm.org/Protocols/Kirby-Bauer-Disk-Diffusion-Susceptibility-Test-Pro> (accessed 11Dec20).
- 589 37. Bankevich A, Nurk S, Antipov D, et al. SPAdes: a new genome assembly algorithm and its applications
590 to single-cell sequencing. *J Comput Biol* 2012; **19**(5): 455-77.
- 591 38. Jolley KA, Bliss CM, Bennett JS, et al. Ribosomal multilocus sequence typing: universal characterization
592 of bacteria from domain to strain. *Microbiology (Reading)* 2012; **158**(Pt 4): 1005-15.
- 593 39. Larkin MA, Blackshields G, Brown NP, et al. Clustal W and Clustal X version 2.0. *Bioinformatics* 2007;
594 **23**(21): 2947-8.
- 595 40. Sarovich DS, Price EP. SPANDx: a genomics pipeline for comparative analysis of large haploid whole
596 genome re-sequencing datasets. *BMC Res Notes* 2014; **7**: 618.
- 597 41. Huang W, Li L, Myers JR, Marth GT. ART: a next-generation sequencing read simulator. *Bioinformatics*
598 2012; **28**(4): 593-4.
- 599 42. Bolger AM, Lohse M, Usadel B. Trimmomatic: a flexible trimmer for Illumina sequence data.
600 *Bioinformatics* 2014; **30**(15): 2114-20.
- 601 43. Price EP, Viberg LT, Kidd TJ, Bell SC, Currie BJ, Sarovich DS. Transcriptomic analysis of longitudinal
602 *Burkholderia pseudomallei* infecting the cystic fibrosis lung. *Microb Genom* 2018; **4**(8).
- 603 44. Alcock BP, Raphenya AR, Lau TTY, et al. CARD 2020: antibiotic resistance surveillance with the
604 comprehensive antibiotic resistance database. *Nucleic Acids Res* 2020; **48**(D1): D517-D25.
- 605 45. Silva VL, Carvalho MA, Nicoli JR, Farias LM. Aerotolerance of human clinical isolates of *Prevotella* spp.
606 *J Appl Microbiol* 2003; **94**(4): 701-7.
- 607 46. Aziz A, Currie BJ, Mayo M, Sarovich DS, Price EP. Comparative genomics confirms a rare melioidosis
608 human-to-human transmission event and reveals incorrect phylogenomic reconstruction due to polyclonality.
609 *Microb Genom* 2020; **6**(2).
- 610 47. Xie Y, Chen J, He J, et al. Antimicrobial resistance and prevalence of resistance genes of obligate
611 anaerobes isolated from periodontal abscesses. *J Periodontol* 2014; **85**(2): 327-34.
- 612 48. Goddard AF, Staudinger BJ, Dowd SE, et al. Direct sampling of cystic fibrosis lungs indicates that DNA-
613 based analyses of upper-airway specimens can misrepresent lung microbiota. *Proc Natl Acad Sci U S A* 2012;
614 **109**(34): 13769-74.
- 615 49. Pragman AA, Lyu T, Baller JA, et al. The lung tissue microbiota of mild and moderate chronic
616 obstructive pulmonary disease. *Microbiome* 2018; **6**(1): 7.
- 617 50. Dickson RP, Erb-Downward JR, Freeman CM, et al. Bacterial topography of the healthy human lower
618 respiratory tract. *mBio* 2017; **8**(1).
- 619 51. Bassis CM, Erb-Downward JR, Dickson RP, et al. Analysis of the upper respiratory tract microbiotas as
620 the source of the lung and gastric microbiotas in healthy individuals. *mBio* 2015; **6**(2): e00037.
- 621 52. Larsen JM, Steen-Jensen DB, Laursen JM, et al. Divergent pro-inflammatory profile of human dendritic
622 cells in response to commensal and pathogenic bacteria associated with the airway microbiota. *PLoS One* 2012;
623 **7**(2): e31976.
- 624 53. Hedberg ME, Israelsson A, Moore ERB, et al. *Prevotella jejuni* sp. nov., isolated from the small intestine
625 of a child with coeliac disease. *Int J Syst Evol Microbiol* 2013; **63**(Pt 11): 4218-23.
- 626 54. Enaud R, Prevel R, Ciarlo E, et al. The gut-lung axis in health and respiratory diseases: a place for inter-
627 organ and inter-kingdom crosstalks. *Front Cell Infect Microbiol* 2020; **10**: 9.
- 628 55. Bertelsen A, Elborn SJ, Schock BC. Toll like Receptor signalling by *Prevotella histicola* activates
629 alternative NF-kappaB signalling in cystic fibrosis bronchial epithelial cells compared to *P. aeruginosa*. *PLoS One*
630 2020; **15**(10): e0235803.
- 631 56. Di Lorenzo F, Silipo A, Matier T, et al. *Prevotella denticola* lipopolysaccharide from a cystic fibrosis
632 isolate possesses a unique chemical structure. *European J Org Chem* 2016; **9**: 1732-8.
- 633 57. Yanagisawa M, Kuriyama T, Williams DW, Nakagawa K, Karasawa T. Proteinase activity of *Prevotella*
634 species associated with oral purulent infection. *Curr Microbiol* 2006; **52**(5): 375-8.
- 635 58. Alauzet C, Marchandin H, Lozniewski A. New insights into *Prevotella* diversity and medical microbiology.
636 *Future Microbiol* 2010; **5**(11): 1695-718.
- 637 59. Sherrard LJ, Graham KA, McGrath SJ, et al. Antibiotic resistance in *Prevotella* species isolated from
638 patients with cystic fibrosis. *J Antimicrob Chemother* 2013; **68**(10): 2369-74.
- 639 60. Brill SE, Law M, El-Emir E, et al. Effects of different antibiotic classes on airway bacteria in stable COPD
640 using culture and molecular techniques: a randomised controlled trial. *Thorax* 2015; **70**(10): 930-8.
- 641 61. Veloo ACM, Baas WH, Haan FJ, Coco J, Rossen JW. Prevalence of antimicrobial resistance genes in
642 *Bacteroides* spp. and *Prevotella* spp. Dutch clinical isolates. *Clin Microbiol Infect* 2019; **25**(9): 1156 e9- e13.

- 643 62. Sherrard LJ, Tunney MM, Elborn JS. Antimicrobial resistance in the respiratory microbiota of people with
644 cystic fibrosis. *Lancet* 2014; **384**(9944): 703-13.
- 645 63. Hahn A, Burrell A, Fanous H, et al. Antibiotic multidrug resistance in the cystic fibrosis airway
646 microbiome is associated with decreased diversity. *Heliyon* 2018; **4**(9): e00795.
- 647 64. Nelson MT, Wolter DJ, Eng A, et al. Maintenance tobramycin primarily affects untargeted bacteria in the
648 CF sputum microbiome. *Thorax* 2020; **75**(9): 780-90.
- 649 65. Bittar F, Richet H, Dubus JC, et al. Molecular detection of multiple emerging pathogens in sputa from
650 cystic fibrosis patients. *PLoS One* 2008; **3**(8): e2908.
- 651 66. Shakil S, Khan R, Zarrilli R, Khan AU. Aminoglycosides versus bacteria--a description of the action,
652 resistance mechanism, and nosocomial battleground. *J Biomed Sci* 2008; **15**(1): 5-14.
- 653 67. Thornton CS, Surette MG. Potential contributions of anaerobes in cystic fibrosis airways. *J Clin Microbiol*
654 2021; **59**(3).
- 655 68. Sherrard LJ, Schaible B, Graham KA, et al. Mechanisms of reduced susceptibility and genotypic
656 prediction of antibiotic resistance in *Prevotella* isolated from cystic fibrosis (CF) and non-CF patients. *J*
657 *Antimicrob Chemother* 2014; **69**(10): 2690-8.
- 658 69. Parameswaran GI, Sethi S. Long-term macrolide therapy in chronic obstructive pulmonary disease.
659 *CMAJ* 2014; **186**(15): 1148-52.
- 660 70. Arzese AR, Tomasetig L, Botta GA. Detection of *tetQ* and *ermF* antibiotic resistance genes in *Prevotella*
661 and *Porphyromonas* isolates from clinical specimens and resident microbiota of humans. *J Antimicrob*
662 *Chemother* 2000; **45**(5): 577-82.
- 663 71. Fernández-Canigia L, Cejas D, Gutkind G, Radice M. Detection and genetic characterization of beta-
664 lactamases in *Prevotella intermedia* and *Prevotella nigrescens* isolated from oral cavity infections and
665 peritonsillar abscesses. *Anaerobe* 2015; **33**: 8-13.
- 666 72. Sherrard LJ, McGrath SJ, McIlreavey L, et al. Production of extended-spectrum β -lactamases and the
667 potential indirect pathogenic role of *Prevotella* isolates from the cystic fibrosis respiratory microbiota. *Int J*
668 *Antimicrob Agents* 2016; **47**(2): 140-5.
- 669 73. Jolivet-Gougeon A, Tamanai-Shacoori Z, Desbordes L, Burggraeve N, Cormier M, Bonnaure-Mallet M.
670 Genetic analysis of an ambler class A extended-spectrum beta-lactamase from *Capnocytophaga ochracea*. *J*
671 *Clin Microbiol* 2004; **42**(2): 888-90.
- 672 74. Alauzet C, Mory F, Teyssier C, et al. Metronidazole resistance in *Prevotella* spp. and description of a
673 new *nim* gene in *Prevotella baroniae*. *Antimicrob Agents Chemother* 2010; **54**(1): 60-4.
- 674 75. Veloo ACM, Chlebowicz M, Winter HLJ, Bathoorn D, Rossen JWA. Three metronidazole-resistant
675 *Prevotella bivia* strains harbour a mobile element, encoding a novel *nim* gene, *nimK*, and an efflux small MDR
676 transporter. *J Antimicrob Chemother* 2018; **73**(10): 2687-90.
- 677 76. Allison HE, Hillman JD. Cloning and characterization of a *Prevotella melaninogenica* hemolysin. *Infect*
678 *Immun* 1997; **65**(7): 2765-71.
- 679 77. Zhou X, Li Y. Subgingival microbes: from healthy microflora to disease. *Atlas of Oral Microbiology*:
680 Elsevier; 2015.
- 681 78. Finegold SM. Anaerobic Gram-negative bacilli (Chapter 20). In: Baron S, ed. *Medical Microbiology* (4th
682 edition). Galveston, TX: University of Texas Medical Branch at Galveston; 1996.

Amplification

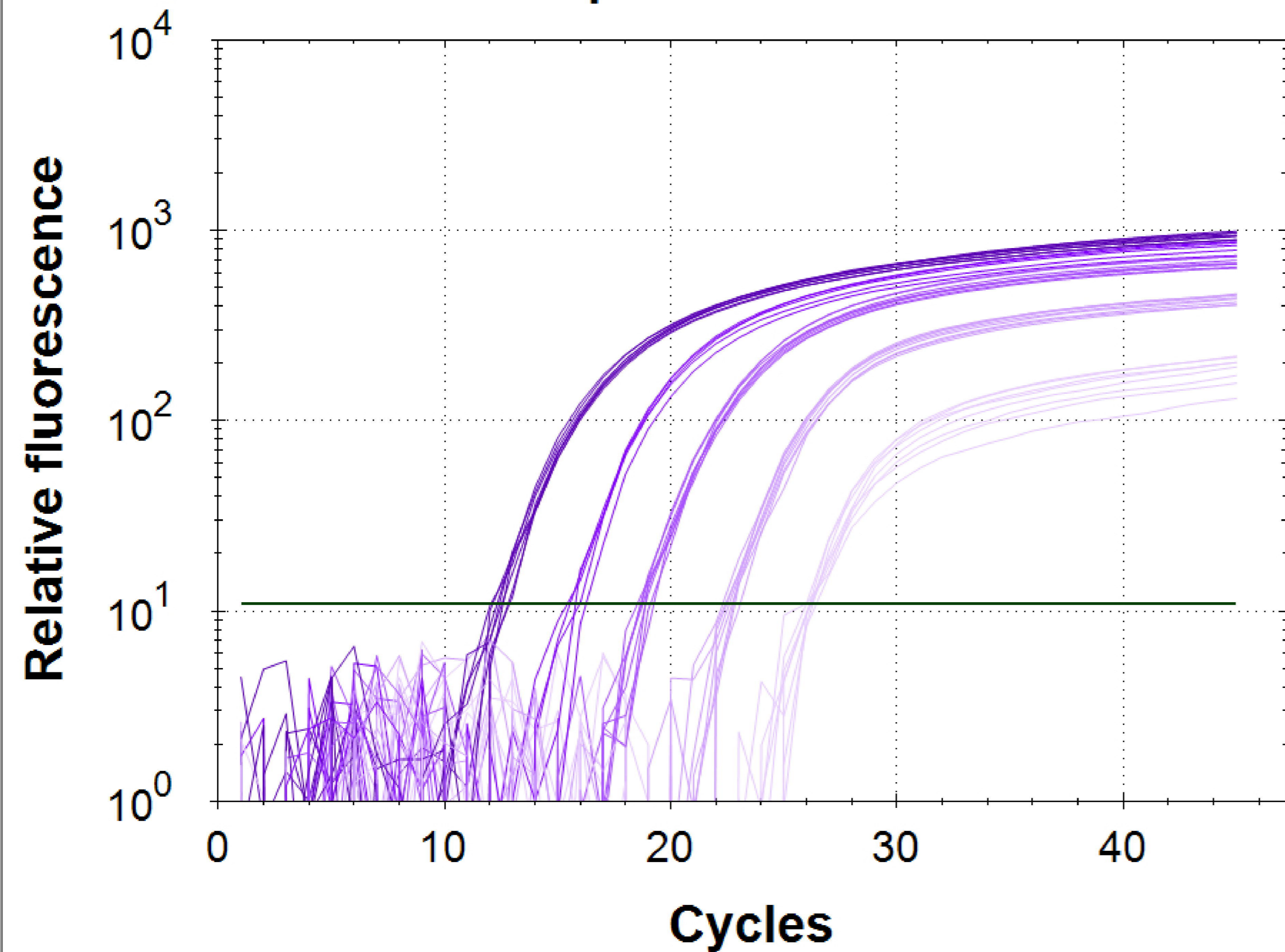

Standard Curve

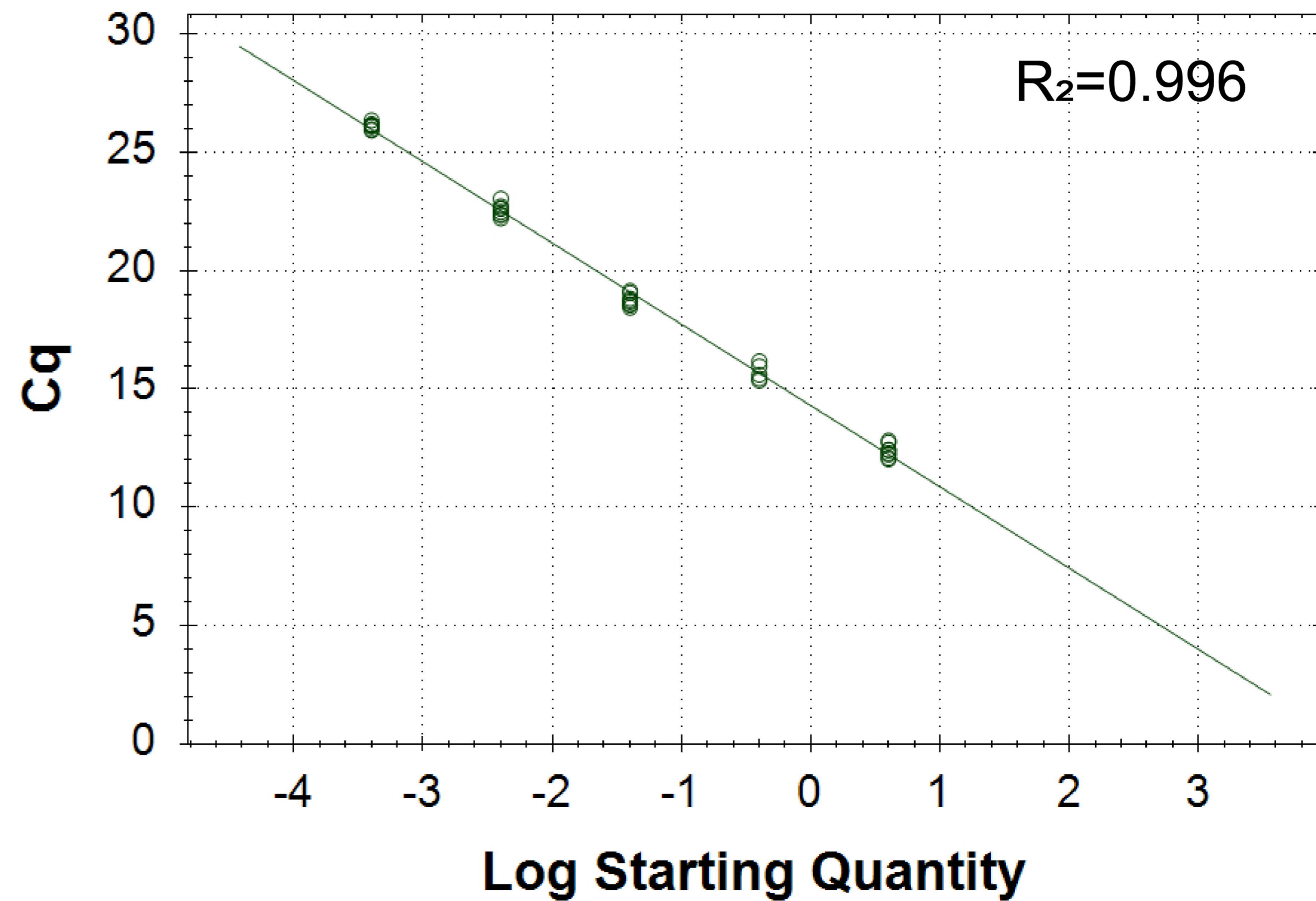

Prevotella denticola

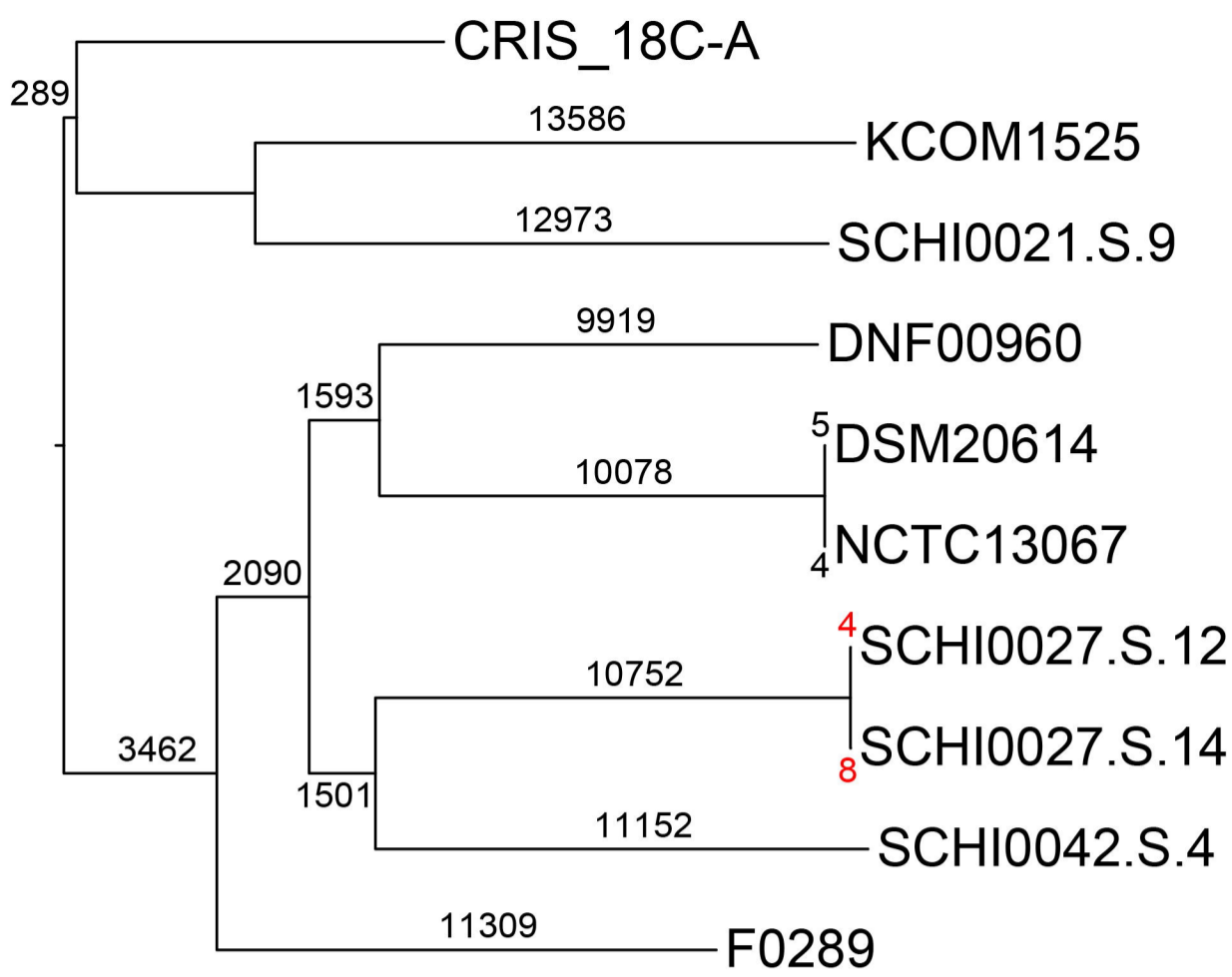

CI=0.66

3000 SNPs

Prevotella histicola

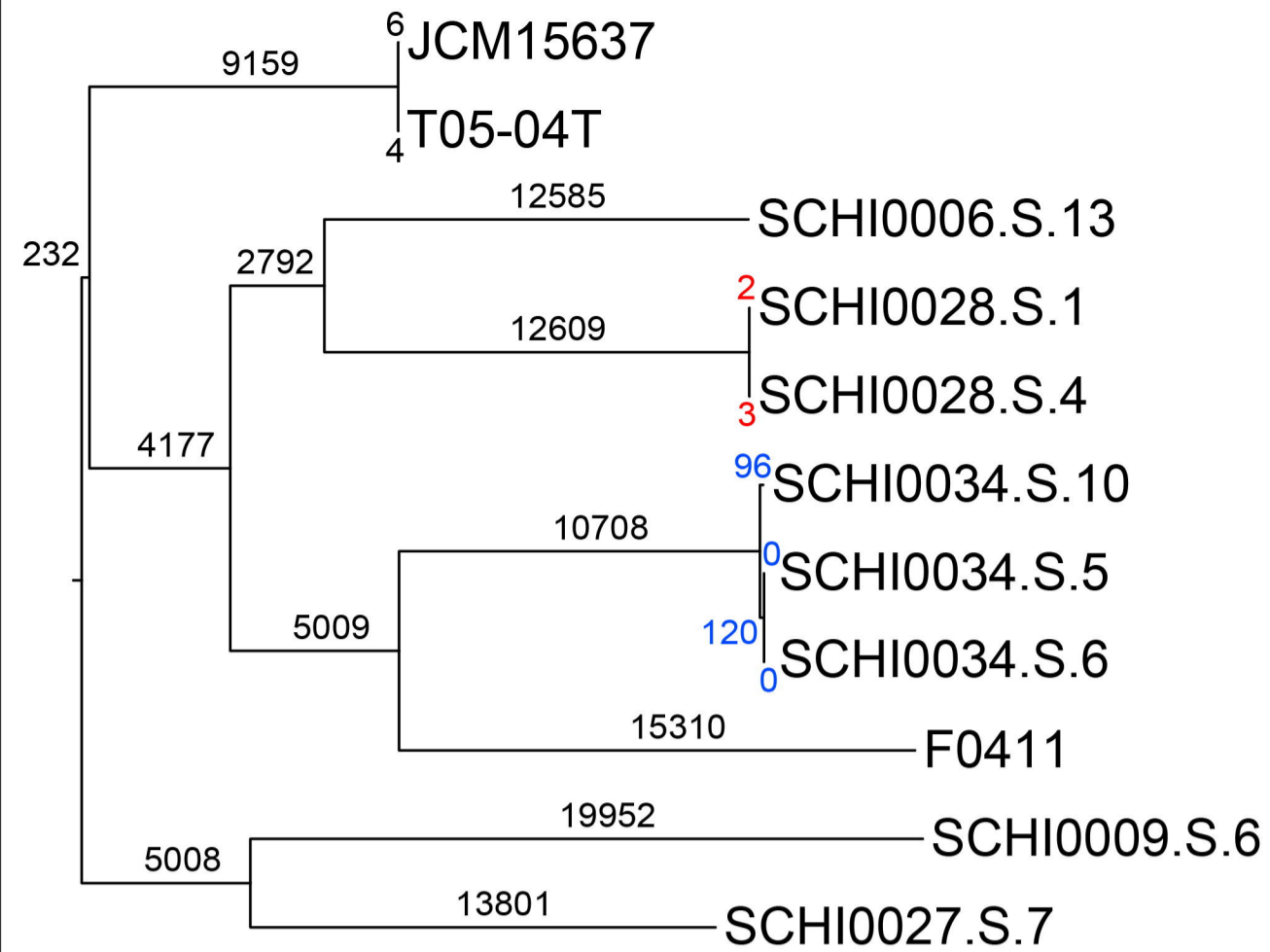

CI=0.66

5000 SNPs

Prevotella nanceiensis

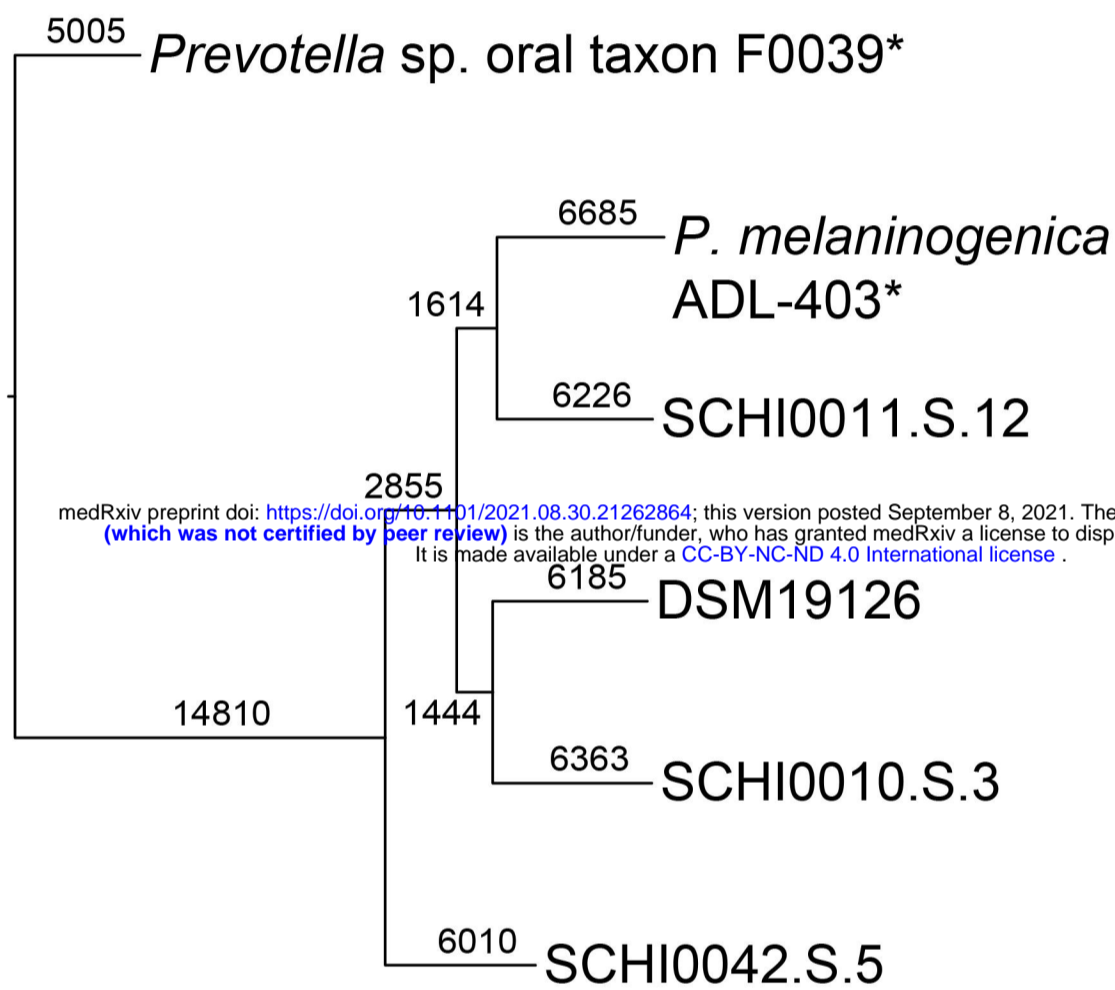

CI=0.81

3000 SNPs

Prevotella salivae

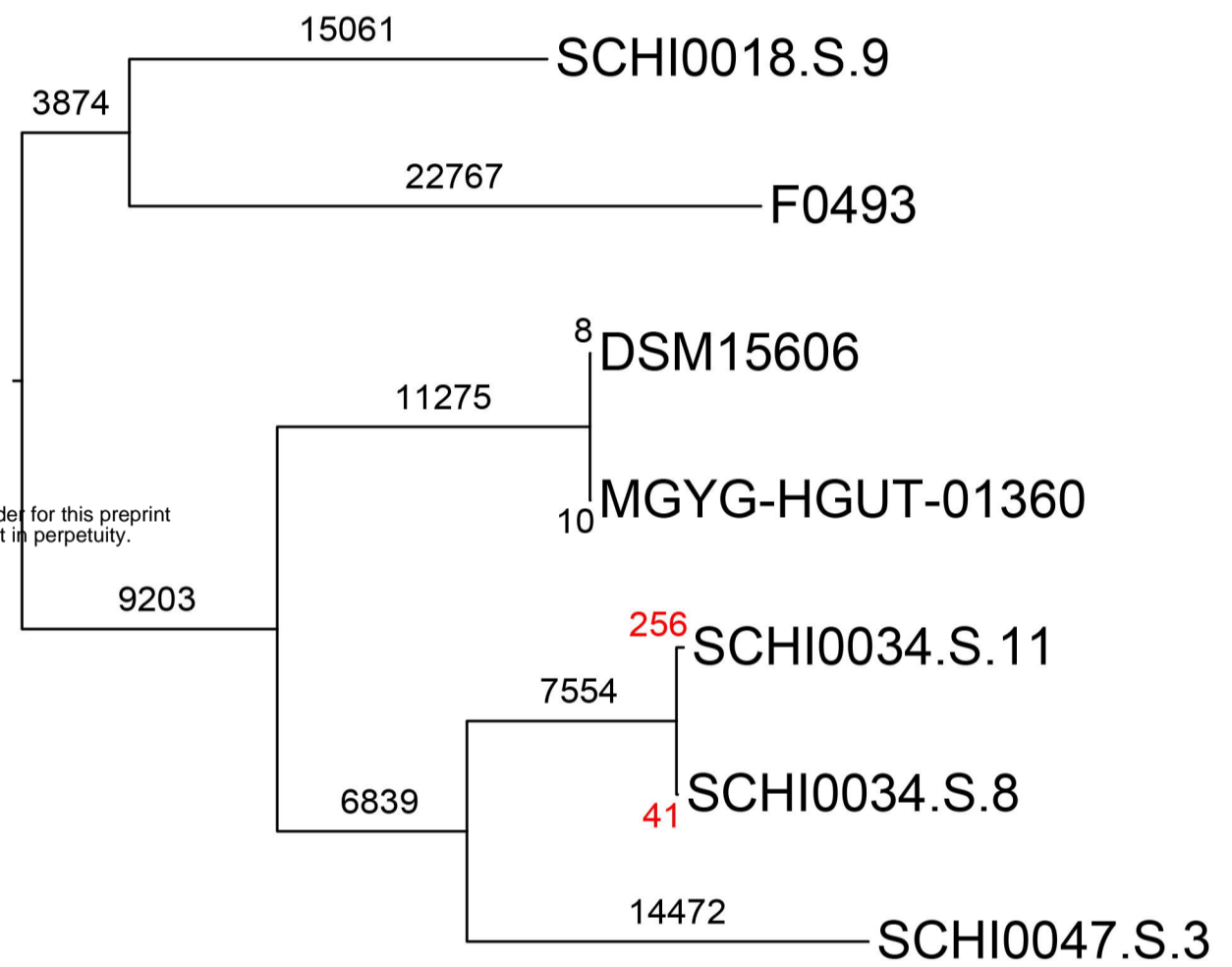

CI=0.82

4000 SNPs

Prevotella melaninogenica

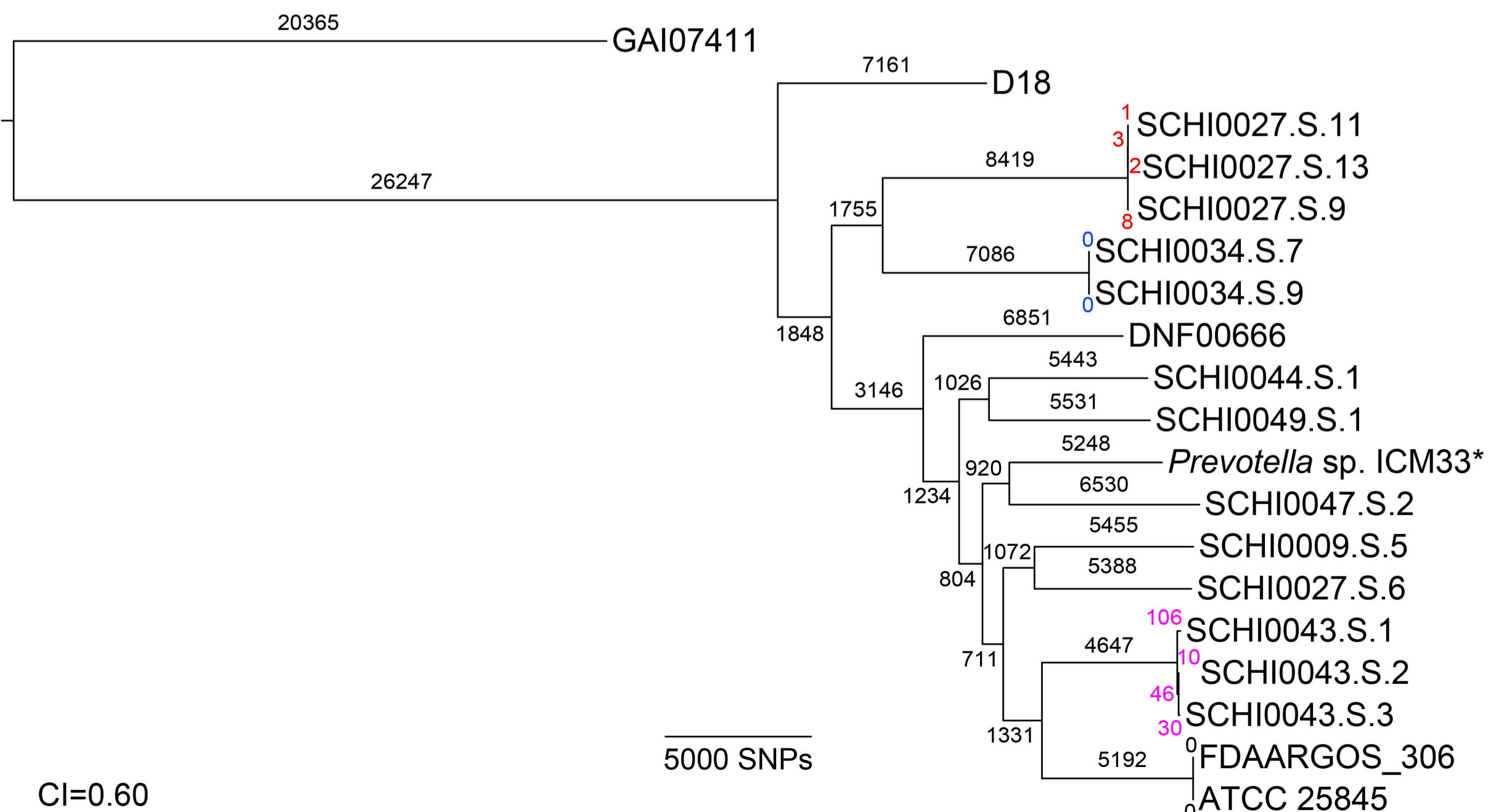

CI=0.60

5000 SNPs

