

1 **Title: Clinical Utility of a Highly Sensitive Lateral Flow Immunoassay as determined by**  
2 **Titer Analysis for the Detection of anti-SARS-CoV-2 Antibodies at the Point-of-Care**

3 **Authors:** Amanda Haymond<sup>1†</sup>, Claudius Mueller<sup>1†</sup>, Hannah Steinberg<sup>2</sup>, K. Alex Hodge<sup>1</sup>, Caitlin  
4 Lehman<sup>3</sup>, Shih-Chao Lin<sup>3</sup>, Lucia Collini<sup>4</sup>, Heather Branscome<sup>5</sup>, Tuong Vi Nguyen<sup>1</sup>, Sally  
5 Rucker<sup>1</sup>, Lauren Panny<sup>3</sup>, Rafaela Flor<sup>3</sup>, , Raouf Guirgus<sup>1</sup>, Richard Hoefler<sup>6</sup>, Giovanni Lorenzin<sup>4</sup>,  
6 Emanuel Petricoin, Fatah Kashanchi<sup>5</sup>, Kylene Kehn-Hall<sup>3</sup>, Paolo Lanzafame<sup>4</sup>, Lance Liotta<sup>1</sup>,  
7 Alessandra Luchini<sup>1</sup>

8

9 \*corresponding author, [ahaymond@gmu.edu](mailto:ahaymond@gmu.edu)

10 † Amanda Haymond and Claudius Mueller contributed equally to this work. Author order was  
11 determined based on manuscript drafting.

12

13 **Affiliations:**

14 <sup>1</sup>Center for Applied Proteomics and Molecular Medicine, George Mason University, Manassas,  
15 VA

16 <sup>2</sup>Department of Microbiology and Immunology, University of Illinois, Chicago, Chicago, IL

17 <sup>3</sup>National Center for Biodefense and Infectious Disease, George Mason University, Manassas,  
18 VA

19 <sup>4</sup>Department of Microbiology and Virology, Country Health Service, S. Chiara Hospital, Trento,  
20 IT

21 <sup>5</sup>Laboratory of Molecular Virology, George Mason University, Manassas VA

22 <sup>6</sup>Sentara Dorothy G. Hoefler Comprehensive Breast Center, Newport News, VA

23

24 **Abstract:**

25 Coronavirus disease 2019 (COVID-19), caused by the severe acute respiratory  
26 syndrome coronavirus-2 (SARS-CoV-2), became a pandemic in early 2020. Lateral flow  
27 immunoassays for antibody testing have been viewed as a cheap and rapidly deployable  
28 method for determining previous infection with SARS-CoV-2; however, these assays have  
29 shown unacceptably low sensitivity. We report on nine lateral flow immunoassays currently  
30 available and compare their titer sensitivity in serum to a best-practice enzyme-linked  
31 immunosorbent assay (ELISA) and viral neutralization assay. For a small group of PCR-  
32 positive, we found two lateral flow immunoassay devices with titer sensitivity roughly equal to  
33 the ELISA; these devices were positive for all PCR-positive patients harboring SARS-CoV-2  
34 neutralizing antibodies. One of these devices was deployed in Northern Italy to test its sensitivity  
35 and specificity in a real-world clinical setting. Using the device with fingerstick blood on a cohort  
36 of 27 hospitalized PCR-positive patients and seven hospitalized controls, ROC curve analysis

37 gave AUC values of 0.7646 for IgG. For comparison, this assay was also tested with saliva from  
38 the same patient population and showed reduced discrimination between cases and controls  
39 with AUC values of 0.6841 for IgG. Furthermore, during viral neutralization testing, one patient  
40 was discovered to harbor autoantibodies to ACE2, with implications for how immune responses  
41 are profiled. We show here through a proof-of-concept study that these lateral flow devices can  
42 be as analytically sensitive as ELISAs and adopted into hospital protocols; however, additional  
43 improvements to these devices remain necessary before their clinical deployment.

44 **Introduction**

45 In March of 2020, the novel coronavirus disease 2019 (COVID-19) joined the ranks of  
46 other infectious diseases such as influenza and plague to be categorized as a pandemic. As of  
47 July 13, 2020, roughly 13 million people worldwide have been confirmed to have contracted  
48 COVID-19, leading to over 500,000 fatalities so far (1). While vaccine and therapeutic  
49 interventions are under investigation by almost every qualified scientific body worldwide, there  
50 remain significant challenges associated with reducing spread prior to effective therapeutic  
51 strategies. One hurdle to reducing spread of the disease is the difficulty in the identification of  
52 both actively infected individuals as well as those who have recovered. Active infections,  
53 typically diagnosed by real time reverse transcription polymerase chain reaction (RT-PCR),  
54 have been plagued with false negative issues as well as availability issues in some countries,  
55 including the United States (2–4). Time since infection has proven to be an important source of  
56 variability in real time RT-PCR results due to difficulties in detecting SARS-CoV-2 RNA in  
57 patients prior to development of symptoms, or more than 5 days post-development of symptoms  
58 (5).

59 Rather than using real time RT-PCR to constantly test for active cases, serologic  
60 antibody testing has been proposed as an important tool to determine the prevalence and  
61 spread of SARS-CoV-2 in a community. Positivity rates for the detection of anti-SARS-CoV-2  
62 IgG or IgM in patient serum have been shown to rise above 90% after an average of 11-13 days  
63 from symptom onset, though seroconversion timeframes for IgG as it relates to IgM are not  
64 necessarily comparable between patients (6). Because antibody testing can be quite variable,  
65 there have been concerted efforts to standardize testing. A best-practice ELISA protocol from  
66 the Krammer group at Mt. Sinai has been given EUA approval from the FDA, and reagents from  
67 this lab have been widely distributed through BEI Resources (7, 8). Additionally, the National  
68 Institutes of Health (NIH) has released a broadly similar optimized ELISA protocol that is being  
69 adopted for serostudies conducted through the NIH (9). Other groups have reported using

70 similar ELISA protocols with the recombinant HEK293-produced spike receptor binding domain  
71 (RBD) protein as the antigen for detection (10). Despite the complications of inter-patient  
72 variability and assay timing, ELISA antibody tests have been able to successfully detect robust  
73 IgG responses in the vast majority of SARS-CoV-2 infected individuals regardless of clinical  
74 severity (6, 7, 11–14). For this reason, serology testing remains a promising lead for  
75 understanding the incidence and spread of COVID-19, difficulties notwithstanding.

76 One approach to overcoming some of the challenges associated with serologic antibody  
77 testing is the introduction of lateral flow immunoassays (LFIs): cheap devices that can be rapidly  
78 produced and given/interpreted by medical professionals without the need for a laboratory (15).  
79 Because of the low cost and high availability, LFIs have the potential to be widely deployed.  
80 There have been several studies comparing different commercially-available LFI tests to a best-  
81 practice ELISA to determine appropriate candidates for more widespread deployment; one  
82 commonly encountered problem is unacceptably low sensitivity (16–18). A recent systematic  
83 review and meta-analysis of 40 such studies found that LFIs for COVID-19 had a pooled  
84 sensitivity of only 66%, well behind pooled ELISA sensitivity at 84% (19). Moreover, most  
85 studies included in the review analyzed LFIs in the laboratory, instead of at the point-of-care  
86 (19).

87 A reason for the overall reduced sensitivity of LFIs versus ELISA assays could be  
88 reduced analytical sensitivity of LFIs (20, 21). There are currently no studies directly comparing  
89 the analytical sensitivity of multiple LFIs against a best-practice ELISA. Therefore, we proposed  
90 to answer two questions: first, are any currently available LFIs as analytically sensitive as an  
91 ELISA? Second, if a suitably sensitive test can be identified, is it sufficiently simple to use and to  
92 interpret such that it could be deployed clinically? To answer these questions, we report herein  
93 on the evaluation of the analytical sensitivity of nine commercially available LFI devices,  
94 including two currently under FDA EUA approval, as compared to a best-practice ELISA.  
95 Furthermore, we conducted a pilot-scale study of the clinical utility of the most analytically

96 sensitive LFI device at the Santa Chiara Hospital in Trento, Italy and report on the sensitivity  
97 and specificity of the device at the point-of-care. This work can be used to inform future studies  
98 both on the promise of LFI devices for detection of previous infection with SARS-CoV-2, as well  
99 as the hurdles to using these devices clinically.

## 100 **Materials and Methods**

101  
102 *George Mason University Patient Cohort*  
103 Patients were recruited from the Northern Virginia area and consented under an IRB-approved  
104 protocol (Liotta PI, 1592168-1); inclusion criteria for the research study included confirmed or  
105 suspected infection with SARS-CoV-2 based on symptoms, contacts, or travel history. A total of  
106 seven PCR-positive or clinically-diagnosed patients donated serum samples that were used in  
107 this study; four patients donated samples at two different time points. On the day of donation,  
108 each patient was consented and donated at least two tubes of blood, one collected in a gel  
109 serum separator tube (SST, gold top 5 mL, BD Vacutainer cat# 368013) and one collected in a  
110 clot-activator serum tube (RT, red top 5 mL, BD Vacutainer cat# 367814). Blood was allowed to  
111 clot for 45-60 minutes at room temperature, and serum was separated via centrifugation (2250 x  
112 g, 15 minutes). Serum was aliquoted and stored at -80°C until analysis.

113  
114 *ELISA*  
115 All patient samples were analyzed by ELISA using a protocol modified from (7), with all changes  
116 noted below. Patient serum samples were heat inactivated for 30 min at 56°C prior to analysis  
117 to ensure samples were non-infectious. ELISA plates (Immulon 1B, ThermoFisher cat# 3355)  
118 were coated overnight at 4°C with 2 µg/mL SARS-CoV-2 spike RBD-mFc tag (Sino Biological  
119 cat# 40592-V05H) produced in HEK293 cells. Serum samples were incubated on antigen  
120 coated plates at 10-fold dilutions ranging from 1:2 to 1:20,000 for 2 hr at room temp. Binding  
121 was detected using 1:5,000 goat anti-human IgG-HRP conjugated secondary (Jackson  
122 Immunoresearch cat# 109-035-098) with TMB substrate (Fisher cat# 34028) for 12 minutes,

123 with the reaction halted via 2 M sulfuric acid. OD450 values were measured on a plate reader.  
124 To correct for intra-plate differences, four calibrator samples consisting of three pre-diluted  
125 positive control sera and a negative control were added to every plate. Samples were  
126 normalized to the geometric mean of the calibrator values. A total of 12 negative serum samples  
127 were used to determine assay background; samples were collected prior to 2019 as healthy  
128 controls for an unrelated breast cancer study. Average of the negative samples plus three  
129 standard deviations at each dilution was used as the background value. Samples were  
130 considered above background if the mean value minus average standard deviation for the  
131 sample was greater than the background value at a given serum dilution; differences less than  
132 0.05 abs units were considered insignificant.

133  
134 *Lateral Flow Immunoassay Titer Analysis*

135 Combined anti-SARS-CoV-2 IgG/IgM lateral flow immunoassays were obtained from the  
136 following manufacturers: Pinnacle Biolabs SARS CoV-2 IgG/IgM One Step Rapid Test Device  
137 (Pinnacle); Wuhan EasyDiagnosis Biomedicine Co., Ltd COVID-19 (SARS-CoV-2) IgM/IgG  
138 Antibody Test Kit, reference SA-2-D (EDiagnostics); SafeCare Bio-Tech COVID-19 IgG/IgM  
139 Rapid Test Device (WB/S/P) ref NCO-4022 (SafeCare), AcroBiotech 2019-nCoV IgG/IgM Rapid  
140 Test Cassette reference INCP-402 (AcroBiotech); LumiQuick Diagnostics Quick Profile 2019  
141 nCoV IgG/IgM Test Card ref 71108B (LumiQuick); Cellex qSARS-COV-2 IgG/IgM Rapid Test  
142 (Cellex); CALTH Care Health AllCheck COVID-19 IgG/IgM reference CHR09E (AllCheck); and  
143 Healgen COVID-19 IgG/IgM (Whole Blood/Serum/Plasma) Rapid Test Device reference  
144 GCCOV-402a (Healgen). Separate anti-SARS-CoV-2 IgG and IgM tests were obtained from  
145 RayBiotech: Coronavirus (SARS-CoV-2) IgG Test Kit ref CG-COV-IgG (RayBiotech IgG), and  
146 Coronavirus (SARS-CoV-2) IgM Test Kit ref CG-CoV-IgM-FP (RayBiotech IgM). Tests were  
147 conducted as recommended by the manufacturers, with a few modifications. Inactivated serum  
148 (20  $\mu$ L for Pinnacle, EDiagnostics, SafeCare, AcroBiotech, and RayBiotech; 10  $\mu$ L for Cellex  
149 and AllCheck, 5  $\mu$ L for Healgen, and 2  $\mu$ L for LumiQuick as recommended in each instruction

150 manual) were pipetted directly on the absorbent sample pad of each test. Immediately following  
151 sample deposition, 2-3 drops of buffer included in each kit were added to the sample pad to  
152 start the flow of the sample up the lateral flow strip. Results were scored between 10-20 minutes  
153 following sample deposition for every test by three independent scorers using a 3-point scale.  
154 Absence of a line, or a negative result, was scored as 0; clear presence of a line, or a positive  
155 result, was scored as a 2; and a faint line that neared the limit of detection for the scorer or was  
156 difficult to see was scored as a 1. All scores were averaged, and the score for a given test was  
157 considered positive if the average of the three scores was greater than 1. Titers were  
158 determined for each test as the highest dilution of serum that scored greater than 1 for a given  
159 patient. Agreement between readers for LFI data was determined via Fleiss' kappa statistic,  
160 Krippendorff's alpha statistic, and percent agreement as calculated by STATA 13 (StataCorp.  
161 2013. *Stata Statistical Software: Release 13*. College Station, TX: StataCorp LP) for three  
162 readers with three variable assignments. For Fleiss' kappa,  $0.4 < \kappa < 0.75$  indicated mild to  
163 moderate agreement, and  $\kappa > 0.75$  indicated strong agreement as recommended in (22).

#### 164 *Viral Neutralization Assay*

165  
166  
167 Viral neutralization assays were conducted under BSL-3 conditions at George Mason  
168 University's Biomedical Research Laboratory using standard methods. Briefly, SARS-CoV-2  
169 USA-WA1/2020 isolate (BEI Resources, Cat # NR-52281) was added to twofold serially diluted  
170 sera at a concentration of 94 pfu/well. Vero cells were infected using the diluted sera and virus  
171 mixture and were incubated for 1h at 37°C. Following infection, a 1-mL overlay of a 1:1 solution  
172 of 0.6% agarose in diH<sub>2</sub>O and 2x EMEM supplemented with 5% FBS, 1% L-glutamine, 1%  
173 penicillin/streptomycin, 1% non-essential amino acids, and 1% sodium pyruvate was added to  
174 the cells. The cells were incubated at 37°C and 5% CO<sub>2</sub> for 48 hours. After 48 hours, the cells  
175 were fixed using 10% formaldehyde for 1 hour at room temperature. Following fixation, the  
176 formaldehyde and agar plugs were discarded. The cell monolayers were stained with a solution

177 of 2% crystal violet and 20% ethanol to visualize plaques. Percent neutralization was calculated  
178 as: [(number of SARS-CoV-2 plaques per well without anti-SARS-CoV-2 serum) – (number of  
179 SARS-CoV-2 plaques per well of diluted anti-SARS-CoV-2 serum) / (number of SARS-CoV-2  
180 plaques per well without anti-SARS-CoV-2 serum) x 100]. Neutralizing titers were expressed as  
181 the reciprocal of the highest dilution of serum that neutralized 90% of SARS-CoV-2. Samples  
182 with PRNT<sub>90</sub>> 1:160 were considered positive, as recommended for convalescent plasma  
183 donation by the FDA (23).

#### 184 *Western Blot Analysis*

185 Serum samples from patients 1F, 8F, 10F, and an uninfected negative control individual were  
186 examined for the presence of anti-ACE2 or anti-S antibodies. All samples for this analysis were  
187 provided from the first donations of each patient collected in gel serum separator tubes (SST).  
188 Whole cell extracts from A549 and Vero E6 were analyzed via BCA assay per the  
189 manufacturer's recommendations (Thermo Fisher Scientific). For western blot, equal amounts  
190 of protein were mixed with NuPAGE LDS sample buffer and NuPAGE sample reducing agent,  
191 heated at 70°C, and separated on a NuPAGE 4-12% Bis-Tris protein gel (Thermo Fisher  
192 Scientific). Proteins were transferred to a Nitrocellulose membrane using the iBlot 2 gel transfer  
193 device. Membranes were blocked with 5% milk in TBS with 0.1% Tween 20. Appropriate  
194 antibodies or patient samples were added for overnight incubation at 4°C. Membranes were  
195 washed, incubated with the appropriate secondary antibodies at 4°C, and developed with either  
196 Clarity or Clarity Max Western ECL Substrate (Bio-Rad). Chemiluminescence imaging was  
197 performed using either the Azure cSeries imaging system (Azure Biosystems) or the ChemiDoc  
198 Touch Imaging System (Bio-Rad). Antibodies used for these experiments included  $\alpha$ -Actin  
199 (Abcam # ab-49900).

#### 200 *Clinical Analysis of Lateral Flow Immunoassay*

201 Lateral flow immunoassays from two manufacturers (RayBiotech and SafeCare) were sent to  
202 the Santa Chiara Hospital in Trento, Italy for analysis in the clinical setting. PCR-positive



203 patients who had been in the hospital greater than 10 days (n = 27) were consented under IRB  
204 compliance. Each patient provided a saliva sample by depositing the sample in a  
205 microcentrifuge tube. Saliva samples were centrifuged to separate cellular/food debris from the  
206 supernatant. Saliva supernatant was aspirated into the kit-provided plastic droppers to the fill  
207 point recommended by the LFI manufacturer and deposited on the absorbent sample pad of the  
208 LFI test. Fingerstick blood samples were obtained by piercing the skin with a sterile lancet, and  
209 a single drop of blood was expressed and spotted onto the absorbent sample pad of the LFI  
210 test. Following deposition of either the saliva or the fingerstick blood sample, 2-3 drops of  
211 included sample buffer was added directly to the sample pad to start the flow of sample up the  
212 lateral flow strip. Test strips were read at 20 minutes post sample deposition and were scored  
213 upon visual inspection by with agreement from at least two nurses. Seven PCR-negative  
214 hospitalized patients provided saliva and blood samples as the negative controls. To determine  
215 sensitivity and specificity of LFI tests in the healthcare setting for saliva and fingerstick blood,  
216 receiver-operator characteristic (ROC) curves were generated with GraphPad Prism version  
217 8.4.3. Two by two tables used to determine positive predictive value (PPV), negative predictive  
218 value (NPV), sensitivity, and specificity were generated using Microsoft Excel.

219 **Results**

220

221 *Lateral flow immunoassay analysis of PCR-positive patient serum indicates some lateral flow*  
222 *kits can reach ELISA sensitivity levels*

223 A total of five RT-PCR positive patients (1F, 8F, 10F, 20M, and 27F), as well as two  
224 patients with a clinical COVID-19 diagnosis (7F and 19F), donated serum towards our analytical  
225 sensitivity study comparing a best-practice ELISA assay versus nine commercially available LFI  
226 devices. While Patient 7F and Patient 19F were both clinically diagnosed based on symptoms,  
227 Patient 19F additionally shared a household with a RT-PCR positive patient 20M. Patients 1F,  
228 7F, 19F, and 20F provided two samples for a total of 11 unique samples for analysis. Table 1  
229 reports the clinical details for each included patient. The first serum donations collected from the  
230 first six donors (1F, 7F, 8F, 10F, 19F, 20M) were used to screen all nine lateral flow devices;  
231 devices that performed well were brought forward to a secondary screen, which included the  
232 remaining five serum samples. We adopted a similar ELISA protocol to that of the Krammer  
233 group and the NIH (8, 9) with minimal modifications. Primarily, we conducted a single-tiered  
234 screening protocol using the spike receptor binding domain (RBD, Sino Biological) rather than a  
235 two-tiered screening protocol using first the RBD, then the full-length spike (S) protein. It has  
236 been shown that convalescent patients possessing S-reactive antibodies also possess RBD-  
237 reactive antibodies (7).

238 As shown in Figure 1, five of the six patients were determined to have anti-SARS-CoV-2  
239 RBD-reactive IgG antibodies at levels above assay background (dotted line in Figure 1) via  
240 ELISA. Patient 7F did not have detectable antibodies above background via ELISA at any  
241 dilution, and thus could not be included in the analytical sensitivity analysis. ELISA titers  
242 detected in patients 1F, 8F, 10F, 19F, and 20M range between 1:200 to 1:20,000 dilution of  
243 serum. The lowest dilution of serum which was positive above background via ELISA provided  
244 the “benchmark” for the titers for a patient; this benchmark is noted with a gold line in Figure 1.  
245 LFIs were then evaluated for their analytical sensitivity and compared to this ELISA benchmark.

246 For most patients, an IgG LFI device from RayBiotech (Figure 1, in blue) proved the  
247 most sensitive of the LFIs tested, hitting the ELISA benchmark shown in gold for two of the five  
248 tested patients in the first screen. Additionally, patients 1F (Figure 1A), 10F (Figure 1C), and  
249 19F (Figure 1D) showed values in the ELISA above background only by a very small margin,  
250 suggesting that even in patients 8F and 19F, the RayBiotech device was very sensitive. An LFI  
251 device from EDiagnostics (Figure 1, in orange) also performed well, with titers equaling that of  
252 the ELISA in one of the five patients. Each LFI was tested with dilutions of serum ranging from  
253 1:2 to 1:20,000 as well as undiluted serum. Device scoring was conducted using a 3-point scale  
254 in which 0 represented a negative result (absence of a test line), 2 represented a positive result  
255 (presence of a test line), and 1 represented an indeterminate result (line at the reader's visual  
256 limit of detection). Three readers independently scored each kit, and the average of the three  
257 scores was used to report LFI results (Figure 1 and Supplementary Figure 1). Raw data is  
258 reported in Supplementary Table 1. For a particular serum dilution to be considered positive via  
259 LFI, the average score from all three readers for that test had to be greater than 1. Because the  
260 LFI titer sensitivity is the average of three scores, it should be kept in mind that the titer  
261 sensitivity value reported does have intrinsic error, the quantification of which is further  
262 discussed in Table 2.

263 IgG responses have been reported to be more reliable via lateral flow than IgM  
264 responses. This is attributed to the low affinity of IgM antibodies and the narrow window in  
265 which IgM antibody concentrations are high (24). While all IgG LFIs were positive with undiluted  
266 serum for all patients, there was a marked reduction in agreement between LFI devices for the  
267 presence of anti-SARS-CoV-2 IgM antibodies, even with undiluted serum. As shown in Table  
268 S1, some devices showed higher scores at lower dilutions (i.e. 1:20 versus undiluted),  
269 complicating analytical sensitivity analysis. The strict time dependence for detection of IgM  
270 antibodies and known reduced sensitivity of IgM versus IgG LFIs for the detection of previous

271 SARS-CoV-2 infection (16) led us to focus on IgG results as the more clinically relevant  
272 antibody isotype, with IgM results presented in the supplementary Table S1 and Figure S1.

273         Based on the results of the first screen, a secondary screen with the remaining five  
274 samples was conducted with the highest sensitivity LFIs, EDiagnostics and RayBiotech, along  
275 with a representative from the lower sensitivity LFI group, SafeCare, which reports using the  
276 same antigen as the RayBiotech test. For the secondary screen, one new patient was tested  
277 (27F), as well as repeat donations from 1F, 7F, 19F, and 20M, marked as “D2” for second  
278 donation. As shown in Figure 2, the EDiagnostics and RayBiotech test kits were again found to  
279 be more analytically sensitive than the SafeCare test. Patient 7F again tested negative via all  
280 LFIs and ELISA. For LFI+ patients who donated two samples (1F, 19F, 20M), no significant  
281 difference in titer level was detected between donation dates, which were three weeks apart for  
282 these three patients. The EDiagnostics test was as analytically sensitive as the ELISA in three  
283 patients’ samples (1F:D2, 20M:D2, and 27F), while the RayBiotech test was as analytically  
284 sensitive as the ELISA in one patient’s samples (1F:D2).

285         Only four of the nine manufacturers have directly reported the antigens used as bait for  
286 the patient IgG and IgM. Both SafeCare and RayBiotech report using solely the N protein,  
287 Healgen reports using the S protein, and Cellex reports using both N and S. This is of particular  
288 interest as the RayBiotech test showed roughly equivalent titer sensitivity to the in-house ELISA,  
289 despite using a different antigen (N vs S RBD). Previous reports comparing SARS-CoV-2  
290 antibody ELISAs utilizing S RBD protein versus N protein have shown increased sensitivity and  
291 specificity when using the S protein (10).

292         When comparing the nine tests, it becomes clear that there can be a trade-off between  
293 sensitivity and line intensity. Table 2 reports the Fleiss’ kappa, Krippendorff’s alpha, and percent  
294 agreement values for each test, including combined results for both IgG and IgM for all LFIs  
295 tested in the first and second screens (IgG and IgM values are reported separately in Table S2  
296 and S3). These metrics describe the relative agreement in scores given by each of the three

297 readers. Focusing on the kappa value as an example, all tests kits had kappa values greater  
298 than 0.4, outside of the RayBiotech test which scored a 0.399, which indicates mild to moderate  
299 agreement. Three tests had kappa values greater than 0.75, indicated strong agreement as  
300 recommended by (22). While test kits from RayBiotech and EDiagnostics were the most  
301 sensitive kits tested (Figure 1), they also displayed the lowest Fleiss' kappa values (Table 2).  
302 Conversely, the test kit with the lowest sensitivity, available from LumiQuick, displayed the  
303 highest Fleiss' kappa value. We can report qualitatively that those test kits with higher Fleiss  
304 kappa scores, such as LumiQuick, Pinnacle, and AcroBiotech, had test lines that were more  
305 intense and more easily distinguished from background over kits with higher kappa values,  
306 leading to improved agreement in scoring. We propose that while the RayBiotech and  
307 EDiagnostics kits were the most analytically sensitive, much of that sensitivity is garnered by  
308 weak positive results at high dilution, which were inconsistently scored between readers. It is  
309 worth considering that while sensitivity has been reported as a key weakness of lateral flow  
310 immunoassay devices, simple increases in sensitivity may not directly translate to clinical  
311 performance due to issues in consistent scoring between readers.

312 *Viral neutralization confirms protection in all ELISA-positive patients, but some infected patients*  
313 *may develop anti-host versus anti-viral antibodies, complicating interpretation*

314  
315         Based on the results of the ELISA titer analysis and LFI titer analysis on a small group of  
316 five PCR-positive patients and two clinically-diagnosed patients, we determined that one  
317 clinically-diagnosed patient 7F did not possess significant anti-S RBD antibodies (ELISA) or  
318 anti-N antibodies (RayBiotech, SafeCare LFIs) in serum above background. Current preprint  
319 literature suggests that some patients who are infected produce robust memory T-cell  
320 responses even in the absence of seroconversion (25) indicating that lack of an ELISA or LFI  
321 response in patient 7F does not indicate lack of SARS-CoV-2 infection. Given the absence of  
322 PCR testing in this patient, it is unknown if the patient was truly infected with SARS-CoV-2. To  
323 determine if patient 7F mounted an antibody response but failed to make significant anti-S or

324 anti-N antibodies within ELISA or LFI detection limits, we sought additional information by  
325 utilizing plaque reduction neutralization tests (PRNT). All other patients were included in the  
326 analysis for comparison.

327 As shown in Figure 3A, all patients with detectable antibodies via ELISA and LFI  
328 demonstrated viral neutralization at levels considered suitable for convalescent plasma donation  
329 (PRNT<sub>90</sub> > 160) in both gel serum separator tubes (SST) and clot activator serum tubes (RT)  
330 (23). Patient 7F however had no neutralizing antibodies detected in either sample. Given this  
331 patient's clinical diagnosis based on distinctive symptoms (loss of taste and smell), we decided  
332 to probe 7F's sample for presence for additional factors that indicates infection. There have  
333 been reports that some viral neutralization assays conducted with serum from patients in the  
334 context of SARS showed interference due to autoantibodies (26), but there have not been  
335 reports of this phenomenon yet with SARS-CoV-2 patients. Given this possibility, we conducted  
336 Western blot analysis with the serum of patient 7F compared to PCR-positive 1F, 8F, and 10F  
337 to determine if patient 7F could be making autoantibodies against receptors for SARS-CoV-2,  
338 which could be protective but may not be neutralizing based on the conditions of the PRNT  
339 assay. We specifically considered angiotensin converting enzyme-2 (ACE2), the most well-  
340 known receptor for SARS-CoV-2 (27). As shown in Figure 3B, patient 7F's serum reacted  
341 strongly with the ACE2+ cellular lysates, with significantly higher intensity observed for ACE2  
342 bands with this patient than any other patient examined. Patient 1F and 8F had lower reactivity  
343 to ACE2, while 10F had no detectable reactivity to ACE2. A negative patient without SARS-  
344 COV-2 infection also showed no reactivity to ACE2. Conversely, patients 1F and 8F showed  
345 anti-S antibodies, confirming the ELISA results from Figure 1, while patient 7F was again  
346 negative for S antibodies, as shown in Figure 3C. Interestingly, patient 10F did not have  
347 detectable anti-S antibodies in this assay. Based on this data, where known positive patients  
348 mounted limited anti-ACE2 antibodies (1F and 8F), we conclude that some patients may  
349 produce anti-host antibodies as well to protect against disease. It is possible this was the

350 primary response for patient 7F, explaining why other measures of response were negative. We  
351 conclude that if patient 7F was truly infected likely with SARS-CoV-2, as distinctive symptoms  
352 would suggest, they did not mount significant antibody response against the virus itself that we  
353 could detect, but potentially produced some anti-host antibodies instead. These anti-host  
354 antibodies did not appear neutralizing in this assay. Because of the uncertainty of infection in  
355 patients who did not receive a positive RT-PCR test but only a clinical diagnosis, we did not  
356 include any clinically diagnosed patients as potential positive cases for COVID-19 disease for  
357 our point-of-care analysis.

358 *Highly sensitive lateral flow immunoassay devices used at the point-of-care can distinguish*  
359 *cases from controls but require additional improvements before widespread clinical deployment*  
360 Analytical sensitivity of the RayBiotech and EDiagnosics LFI tests were shown to be  
361 similar to that of the best-practice ELISA in a total of six patients. To determine if this sensitivity  
362 could translate to clinical utility, we tested the RayBiotech LFI devices on 27 PCR-confirmed,  
363 hospitalized patients in Trento, Italy. Due to the results reported in Figure 3, only PCR-  
364 confirmed patients were considered as true positive cases for this clinical study. Each patient  
365 was tested with three lateral flow devices: RayBiotech's IgG test kit, RayBiotech IgM test kit,  
366 and SafeCare's IgG/IgM test kit as a comparison to a less sensitive test. RayBiotech and  
367 SafeCare's tests both use the N protein for detection, allowing for direct comparison between  
368 the two LFI devices. Each patient was tested using fingerstick blood, which both manufacturers  
369 recommend, as well as saliva, which is expected to be lower sensitivity and which no  
370 manufacturer recommended. As shown in Figure 4B, the IgG LFI from RayBiotech was  
371 successfully used in the clinic and could distinguish between cases (N=27) and controls (N=7)  
372 better than chance using fingerstick blood. All 2 by 2 tables are reported in Supplementary  
373 Figure 2. As expected, saliva was a poorer discriminator between cases and controls than was  
374 fingerstick blood using the RayBiotech test; however, it was a better discriminator using the  
375 SafeCare test. This improved AUC value in saliva was driven by the 100% specificity,  
376 determined by no false positive detection in the small sample (N=7) of negative saliva. Thus, it

377 remains to be seen if this test could be used in saliva clinically. The corresponding sensitivity  
378 was particularly poor (48%). Larger studies of saliva will be needed to determine if this biofluid is  
379 a promising source of anti-SARS-CoV-2 antibodies for serostudy detection. Based on this pilot  
380 scale point-of-care study, the RayBiotech test was superior to the SafeCare test in the accuracy  
381 of anti-SARS-CoV-2 IgG detection using fingerstick blood.

## 382 **Discussion**

383 We set out to answer two primary questions in our investigation: first, are there LFI tests  
384 that are as analytically sensitive as the best practice ELISA? Secondly, if such a test were to be  
385 found, could it show improved point-of-care performance over other reported LFI tests? To  
386 answer the first question, we first examined a group of patients (N=7) from the community that  
387 were either PCR-positive or clinically diagnosed to investigate the analytical sensitivity of nine  
388 different LFI devices, including two devices with FDA EUA approval (Cellex and Healgen), using  
389 an ELISA assay as a comparator. To our knowledge, no one has reported a screen of the  
390 analytical sensitivity of multiple LFI devices, and several of the LFI devices in our selection,  
391 including both the RayBiotech and EDiagnostics LFIs, have not been reported in other  
392 publications. We found that the two most analytically sensitive LFIs for this cohort, from  
393 RayBiotech and EDiagnostics, showed similar analytical sensitivity to the ELISA. This potentially  
394 justifies their use in the clinic, which until now has reported poor sensitivity with LFI devices.

395 Based on the analytical sensitivity analysis, it may be useful to consider the role these  
396 tests could have in screening convalescent plasma for donation. In this scenario, specificity  
397 concerns are minimized by only testing PCR-positive patients, while sensitivity concerns are  
398 amplified as one wants to identify all potential convalescent plasma donors. Our small patient  
399 group utilized in the analytical sensitivity study consisted of exclusively non-hospitalized  
400 patients. It may be worth considering using these lateral flow devices as additional tools for  
401 identifying potential convalescent plasma donors, as this is much less time intensive and  
402 expensive than performing viral neutralization assays on potential donors instead.



403 To evaluate how much increased sensitivity could improve the accuracy of LFI tests at  
404 the point-of-care, we performed a pilot-scale clinical evaluation of the sensitive RayBiotech test  
405 against the less sensitive SafeCare test. Both tests report using the N protein as the capture  
406 antigen; this ensures an appropriate comparison between the tests. We found that when  
407 examining fingerstick blood, the RayBiotech test was more sensitive than the SafeCare test, as  
408 hypothesized based on the sensitivity observed in our analytical sensitivity evaluation, but not  
409 by as great a margin as expected (81% versus 78%, respectively, Figure S2). Instead, the  
410 difference in AUC values was driven more by the increased specificity of the RayBiotech test  
411 (71% versus 57%, respectively). Furthermore, it is unclear how significantly the results of such a  
412 screen may be complicated by irreproducible scoring; we found that both the EDiagnostics test  
413 and the RayBiotech test showed only mild correlation when scored by multiple independent  
414 readers in the laboratory. Going forward, the correct balance between sensitivity and consistent  
415 readability will be critical for useful clinical adoption.

416 Both tests, when used on patient saliva, showed reductions in sensitivity as compared to  
417 fingerstick blood, as would be expected. While the SafeCare test showed an improved AUC with  
418 saliva over fingerstick blood, this was driven by the 100% specificity value on a very small  
419 cohort of negative patients (N=7), and it is unclear if saliva would be a suitable biofluid for  
420 analysis with this LFI. Larger trials are ongoing to determine if saliva, either raw or processed to  
421 concentrate antibodies, can be substituted for serum when using lateral flow devices. Given the  
422 noted sensitivity problems even with serum for lateral flow devices, and the fact that saliva  
423 contains a greatly reduced concentration of antibodies as compared to serum (28), it is likely  
424 that some additional processing steps will be required. There have been reports on the use of  
425 saliva for detection of anti-SARS-CoV-2 antibodies (29); to our knowledge, there have not yet  
426 been any reports adapting saliva for use in the context of LFI devices for antibody detection.  
427 This could represent a large improvement in patient acceptability and ease-of-use for

428 serostudies, however, as we show in our point-of-care analysis, saliva remains unsuitable for  
429 this use without further improvements in methodology or devices.

430 In a surprising turn, during the process of evaluating the viral neutralization potential of  
431 patient serum in the analytical sensitivity portion of the study, we did find a noteworthy presence  
432 of anti-ACE2 autoantibodies in the serum of patient 7F, as well as limited anti-ACE2 antibodies  
433 in patient 1F and 8F's samples as well. Patient 7F, with the highest concentration of anti-ACE2  
434 antibodies, reported having hypothyroidism, an autoimmune condition. We speculate that  
435 autoimmune conditions, such as hypothyroidism, may occur in patients with "overactive"  
436 immune systems that are subsequently more likely to harbor autoantibodies such as those  
437 detected against ACE2 over other healthy patients such as 1F and 8F. Further research is  
438 needed to determine if hypothyroidism, or other autoimmune conditions, could impact the  
439 antibody repertoire produced by the host in response to SARS-CoV-2 infection. Furthermore,  
440 our rationale for testing against cellular proteins such as ACE2 was that there were either low to  
441 no antibodies against S antigen and that viral infections usually cause either partial cell damage  
442 or complete cell death (i.e., apoptosis, pyroptosis, etc), where cellular antigens that are normally  
443 hidden/protected from the immune system would now become a source of viable antigens for  
444 the immune system to recognize (i.e., autoantigens). This is also in line with recognition of the  
445 conserved molecular structures expressed by invading microbes named pathogen-associated  
446 molecular patterns (PAMPs), and the uncontrolled inflammation in chronic diseases which  
447 leads to tissue damage generating endogenous danger-associated molecular patterns (DAMPs)  
448 including stress signals such as damaged or apoptotic cells recognized by PRRs (30).  
449 Although these signals promote cellular immunity in acute settings (i.e., NLR, RLR, and TLRs),  
450 we believe that they could also pose as potential source of antigens in chronic cases of  
451 diseases such as COVID-19, where survivors are battling long-term effects (~20% of all  
452 patients). In this case, there are many reports of prolonged symptoms, from chest pain and  
453 gastrointestinal issues to cognitive problems and debilitating fatigue that resemble autoantibody

454 related pathologies including Kawasaki disease (KD), the leading cause of acquired heart  
455 disease in children; rheumatoid arthritis; inflammatory diseases; and a host of other pathologies  
456 including encephalitic syndrome and anosmia (31–34). Future experiments will better define the  
457 role of cellular DAMPs (including other receptor/co-receptors such as Tmprss2, Cathpsin L,  
458 CD147, and Neuropilin-1) in COVID-19 infections and whether a robust and aggressive immune  
459 response present in these patients is against the pathogen only, or a mixture of DAMPs (i.e.,  
460 ACE2 antibodies that also block viral entry into cells) that promote immunogenicity and efficacy  
461 by enhancing innate and cellular immune responses.

462 In summary, the poor sensitivity of LFIs in the context of SARS-CoV-2 antibody  
463 diagnostics has been documented. Here we demonstrate that this is a resolvable challenge, as  
464 several manufacturers have produced very analytically sensitive tests. However, the transition  
465 from the laboratory to the clinic reveals additional problems in specificity and ease of use that  
466 mandate addressing. Furthermore, as others have reported, not all patients make significant  
467 anti-S or anti-N antibodies (35), but may have alternative immune responses to SARS-CoV-2  
468 that are protective. When using antibody tests, one must consider how many truly infected  
469 patients could be missed in the analysis due to alternative immune responses, and one may  
470 want to consider a suite of multiple viral and host proteins to truly understand a patient's  
471 antibody response. We look forward to additional improvements in these antibody tests to allow  
472 them to meet the diagnostic needs of the present moment.

#### 473 **Acknowledgements**

474 We gratefully acknowledge Dr. Aarthi Narayanan for confirming the reported heat sensitivity of  
475 SARS-CoV-2. We thank Dr. Ali Andalibi for his advocacy for our project and support at George  
476 Mason's College of Science. Furthermore, we profusely thank the patients who donated their  
477 serum and their time to answer critical questions for the health of others.

478 **Funding Information and Conflicts of Interest**

479 This work was supported in part by NIAID, National Institutes of Health, Grant R21AI138135 to  
480 AL and Grant R01AI136722 subcontract to AL; NICHD, National Institutes of Health, Grant  
481 R21HD097472 to LL; and funding from the George Mason University Provost's Office. The  
482 funding agencies had no role in experimental design, data analysis, or manuscript preparation.  
483 Authors declare that they have no conflicts of interest with the contents of this article.

484

485 **Author Contributions**

486 AH: Performed LFI experiments, analyzed data, wrote paper  
487 CM: Performed the ELISA experiments, analyzed data  
488 HS: Performed the ELISA experiments, analyzed data  
489 AR: Performed the phlebotomy experiments; George Mason University study coordinator  
490 CL: Performed the viral neutralization experiments  
491 SCL: Performed viral neutralization experiments  
492 LC: Performed the clinical point-of-care experiments  
493 HB: Performed the western blots  
494 TVN: Performed the ELISA experiments  
495 SR: Performed the ELISA experiments  
496 LP: Performed viral neutralization experiments  
497 RF: Performed viral neutralization experiments  
498 RG: Provided reagents (lateral flow test kits)  
499 RH: Provided reagents (control serum samples)  
500 GL: Designed the clinical point-of-care experiments  
501 EP: Designed the patient cohort study, recruited patients  
502 FK: Designed the western blot study, performed the western blots  
503 KKH: Designed the viral neutralization study  
504 PL: Italy study coordinator  
505 LL: Designed the lateral flow immunoassay study, provided funding  
506 AL: Designed the clinical study, analyzed data, provided funding

507 **References**

- 508 1. Times TNY. Coronavirus Map: Tracking the Spread of the Outbreak. The New York Times.
- 509 2. Woloshin S, Patel N, Kesselheim AS. 2020. False Negative Tests for SARS-CoV-2  
510 Infection — Challenges and Implications. *New England Journal of Medicine* 0:null.
- 511 3. CohenFeb. 28 J, 2020, Pm 5:45. 2020. The United States badly bungled coronavirus  
512 testing—but things may soon improve. *Science | AAAS*.
- 513 4. Meyer R. 2020. There's One Big Reason the U.S. Economy Can't Reopen. *The Atlantic*.
- 514 5. Kucirka LM, Lauer SA, Laeyendecker O, Boon D, Lessler J. 2020. Variation in False-  
515 Negative Rate of Reverse Transcriptase Polymerase Chain Reaction–Based SARS-CoV-2  
516 Tests by Time Since Exposure. *Annals of Internal Medicine*.
- 517 6. Long Q-X, Liu B-Z, Deng H-J, Wu G-C, Deng K, Chen Y-K, Liao P, Qiu J-F, Lin Y, Cai X-F,  
518 Wang D-Q, Hu Y, Ren J-H, Tang N, Xu Y-Y, Yu L-H, Mo Z, Gong F, Zhang X-L, Tian W-G,  
519 Hu L, Zhang X-X, Xiang J-L, Du H-X, Liu H-W, Lang C-H, Luo X-H, Wu S-B, Cui X-P, Zhou  
520 Z, Zhu M-M, Wang J, Xue C-J, Li X-F, Wang L, Li Z-J, Wang K, Niu C-C, Yang Q-J, Tang  
521 X-J, Zhang Y, Liu X-M, Li J-J, Zhang D-C, Zhang F, Liu P, Yuan J, Li Q, Hu J-L, Chen J,  
522 Huang A-L. 2020. Antibody responses to SARS-CoV-2 in patients with COVID-19. 6.  
523 *Nature Medicine* 26:845–848.
- 524 7. Amanat F, Stadlbauer D, Strohmeier S, Nguyen THO, Chromikova V, McMahon M, Jiang  
525 K, Arunkumar GA, Jurczynszak D, Polanco J, Bermudez-Gonzalez M, Kleiner G, Aydillo T,  
526 Miorin L, Fierer DS, Lugo LA, Kojic EM, Stoeber J, Liu STH, Cunningham-Rundles C,  
527 Felgner PL, Moran T, García-Sastre A, Caplivski D, Cheng AC, Kedzierska K, Vapalahti O,  
528 Hepojoki JM, Simon V, Krammer F. 2020. A serological assay to detect SARS-CoV-2  
529 seroconversion in humans. *Nature Medicine* 1–4.

- 530 8. COVID-19 | Krammer Laboratory.
- 531 9. Klumpp-Thomas C, Kalish H, Drew M, Hunsberger S, Snead K, Fay MP, Mehalko J,  
532 Shunmugavel A, Wall V, Frank P, Denson J-P, Hong M, Gulten G, Messing S, Hicks J,  
533 Michael S, Gilette W, Hall MD, Memoli M, Esposito D, Sadtler K. 2020. Standardization of  
534 enzyme-linked immunosorbent assays for serosurveys of the SARS-CoV-2 pandemic  
535 using clinical and at-home blood sampling. medRxiv 2020.05.21.20109280.
- 536 10. Liu W, Liu L, Kou G, Zheng Y, Ding Y, Ni W, Wang Q, Tan L, Wu W, Tang S, Xiong Z,  
537 Zheng S. 2020. Evaluation of Nucleocapsid and Spike Protein-Based Enzyme-Linked  
538 Immunosorbent Assays for Detecting Antibodies against SARS-CoV-2. *Journal of Clinical*  
539 *Microbiology* 58.
- 540 11. Ni L, Ye F, Cheng M-L, Feng Y, Deng Y-Q, Zhao H, Wei P, Ge J, Gou M, Li X, Sun L, Cao  
541 T, Wang P, Zhou C, Zhang R, Liang P, Guo H, Wang X, Qin C-F, Chen F, Dong C. 2020.  
542 Detection of SARS-CoV-2-Specific Humoral and Cellular Immunity in COVID-19  
543 Convalescent Individuals. *Immunity* 52:971-977.e3.
- 544 12. Wajnberg A, Mansour M, Leven E, Bouvier NM, Patel G, Firpo A, Mendu R, Jhang J,  
545 Arinsburg S, Gitman M, Houldsworth J, Baine I, Simon V, Aberg J, Krammer F, Reich D,  
546 Cordon-Cardo C. 2020. Humoral immune response and prolonged PCR positivity in a  
547 cohort of 1343 SARS-CoV 2 patients in the New York City region. medRxiv  
548 2020.04.30.20085613.
- 549 13. SARS-CoV-2 infection induces robust, neutralizing antibody responses that are stable for  
550 at least three months | medRxiv.
- 551 14. Dynamics and significance of the antibody response to SARS-CoV-2 infection | medRxiv.

- 552 15. Abbasi J. 2020. The Promise and Peril of Antibody Testing for COVID-19. JAMA  
553 323:1881–1883.
- 554 16. Adams ER, Ainsworth M, Anand R, Andersson MI, Auckland K, Baillie JK, Barnes E, Beer  
555 S, Bell J, Berry T, Bibi S, Carroll M, Chinnakannan S, Clutterbuck E, Cornall RJ, Crook  
556 DW, Silva TD, Dejnirattisai W, Dingle KE, Dold C, Espinosa A, Eyre DW, Farmer H,  
557 Mendoza MF, Georgiou D, Hoosdally SJ, Hunter A, Jeffrey K, Klenerman P, Knight J,  
558 Knowles C, Kwok AJ, Leuschner U, Levin R, Liu C, Lopez-Camacho C, Garrido JCM,  
559 Matthews PC, McGivern H, Mentzer AJ, Milton J, Mongkolsapaya J, Moore SC, Oliveira  
560 MS, Pereira F, Lopez EP, Peto T, Ploeg RJ, Pollard A, Prince T, Roberts DJ, Rudkin JK,  
561 Sanchez V, Screaton GR, Semple MG, Skelly DT, Slon-Campos J, Smith EN, Diaz AJS,  
562 Staves J, Stuart D, Supasa P, Surik T, Thraves H, Tsang P, Turtle L, Walker AS, Wang B,  
563 Washington C, Watkins N, Whitehouse J. 2020. Antibody testing for COVID-19: A report  
564 from the National COVID Scientific Advisory Panel. medRxiv 2020.04.15.20066407.
- 565 17. Whitman JD, Hiatt J, Mowery CT, Shy BR, Yu R, Yamamoto TN, Rathore U, Goldgof GM,  
566 Whitty C, Woo JM, Gallman AE, Miller TE, Levine AG, Nguyen DN, Bapat SP, Balcerak J,  
567 Bylsma S, Lyons AM, Li S, Wong AW, Gillis-Buck EM, Steinhart ZB, Lee Y, Apathy R,  
568 Lipke MJ, Smith JA, Zheng T, Boothby IC, Isaza E, Chan J, Acenas DD, Lee J, Macrae  
569 TA, Kyaw TS, Wu D, Ng DL, Gu W, York VA, Eskandarian HA, Callaway PC, Warriar L,  
570 Moreno ME, Levan J, Torres L, Farrington L, Loudermilk R, Koshal K, Zorn KC, Garcia-  
571 Beltran WF, Yang D, Astudillo MG, Bernstein BE, Gelfand JA, Ryan ET, Charles RC,  
572 lafrate AJ, Lennerz JK, Miller S, Chiu CY, Stramer SL, Wilson MR, Manglik A, Ye CJ,  
573 Krogan NJ, Anderson MS, Cyster JG, Ernst JD, Wu AHB, Lynch KL, Bern C, Hsu PD,  
574 Marson A. 2020. Test performance evaluation of SARS-CoV-2 serological assays.  
575 medRxiv 2020.04.25.20074856.

- 576 18. Montesinos I, Gruson D, Kabamba B, Dahma H, Van den Wijngaert S, Reza S, Carbone V,  
577 Vandenberg O, Gulbis B, Wolff F, Rodriguez-Villalobos H. 2020. Evaluation of two  
578 automated and three rapid lateral flow immunoassays for the detection of anti-SARS-CoV-  
579 2 antibodies. *J Clin Virol* 128:104413.
- 580 19. Bastos ML, Tavaziva G, Abidi SK, Campbell JR, Haraoui L-P, Johnston JC, Lan Z, Law S,  
581 MacLean E, Trajman A, Menzies D, Benedetti A, Khan FA. 2020. Diagnostic accuracy of  
582 serological tests for covid-19: systematic review and meta-analysis. *BMJ* 370.
- 583 20. Bishop JD, Hsieh HV, Gasperino DJ, Weigl BH. 2019. Sensitivity enhancement in lateral  
584 flow assays: a systems perspective. *Lab Chip* 19:2486–2499.
- 585 21. Gordon J, Michel G. 2008. Analytical Sensitivity Limits for Lateral Flow Immunoassays.  
586 *Clin Chem* 54:1250–1251.
- 587 22. Fleiss J, Levin B, Cho Paik M. 2003. *Statistical Methods for Rates and Proportions*, 3rd ed.  
588 Wiley.
- 589 23. Research C for BE and. 2020. Recommendations for Investigational COVID-19  
590 Convalescent Plasma. FDA.
- 591 24. Charles A Janeway J, Travers P, Walport M, Shlomchik MJ. 2001. The distribution and  
592 functions of immunoglobulin isotypes. *Immunobiology: The Immune System in Health and*  
593 *Disease* 5th edition.
- 594 25. Sekine T, Perez-Potti A, Rivera-Ballesteros O, Strålin K, Gorin J-B, Olsson A, Llewellyn-  
595 Lacey S, Kamal H, Bogdanovic G, Muschiol S, Wullimann DJ, Kammann T, Emgård J,  
596 Parrot T, Folkesson E, Rooyackers O, Eriksson LI, Sönnernborg A, Allander T, Albert J,  
597 Nielsen M, Klingström J, Gredmark-Russ S, Björkström NK, Sandberg JK, Price DA,



- 598 Ljunggren H-G, Aleman S, Buggert M, Group KC-19 S. 2020. Robust T cell immunity in  
599 convalescent individuals with asymptomatic or mild COVID-19. bioRxiv  
600 2020.06.29.174888.
- 601 26. Wang Y, Sun S, Shen H, Jiang L, Zhang M, Xiao D, Liu Y, Ma X, Zhang Y, Guo N, Jia T.  
602 2004. Cross-reaction of SARS-CoV antigen with autoantibodies in autoimmune diseases.  
603 *Cell Mol Immunol* 1:304–307.
- 604 27. Gheblawi M, Wang K, Viveiros A, Nguyen Q, Zhong J-C, Turner AJ, Raizada MK, Grant  
605 MB, Oudit GY. 2020. Angiotensin-Converting Enzyme 2: SARS-CoV-2 Receptor and  
606 Regulator of the Renin-Angiotensin System. *Circ Res* 126.
- 607 28. Hettegger P, Huber J, Paßecker K, Soldo R, Kegler U, Nöhhammer C, Weinhäusel A. 2019.  
608 High similarity of IgG antibody profiles in blood and saliva opens opportunities for saliva  
609 based serology. *PLoS One* 14.
- 610 29. Randad PR, Pisanic N, Kruczynski K, Manabe YC, Thomas D, Pekosz A, Klein S,  
611 Betenbaugh MJ, Clarke WA, Laeyendecker O, Caturegli PP, Larman HB, Detrick B, Fairley  
612 JK, Sherman AC, Roupheal N, Edupuganti S, Granger DA, Granger SW, Collins M,  
613 Heaney CD. 2020. COVID-19 serology at population scale: SARS-CoV-2-specific antibody  
614 responses in saliva. medRxiv 2020.05.24.20112300.
- 615 30. Villanueva-Romero R, Gutiérrez-Cañas I, Carrión M, Pérez-García S, Seoane IV, Martínez  
616 C, Gomariz RP, Juarranz Y. 2018. The Anti-Inflammatory Mediator, Vasoactive Intestinal  
617 Peptide, Modulates the Differentiation and Function of Th Subsets in Rheumatoid Arthritis.  
618 *J Immunol Res* 2018.
- 619 31. Lindquist ME, Hicar MD. 2019. B Cells and Antibodies in Kawasaki Disease. *Int J Mol Sci*  
620 20.

- 621 32. Pougá L. 2020. Encephalitic syndrome and anosmia in COVID-19: do these clinical  
622 presentations really reflect SARS-CoV-2 neurotropism? A theory based on the review of 25  
623 COVID-19 cases. *J Med Virol*.
- 624 33. Hayashi T, Momota M, Kuroda E, Kusakabe T, Kobari S, Makisaka K, Ohno Y, Suzuki Y,  
625 Nakagawa F, Lee MSJ, Coban C, Onodera R, Higashi T, Motoyama K, Ishii KJ, Arima H.  
626 2018. DAMP-Inducing Adjuvant and PAMP Adjuvants Parallely Enhance Protective Type-  
627 2 and Type-1 Immune Responses to Influenza Split Vaccination. *Front Immunol* 9.
- 628 34. Fraison J-B, Sève P, Dauphin C, Mahr A, Gomard-Mennesson E, Varron L, Pugnet G,  
629 Landron C, Roblot P, Oziol E, Chalhoub G, Galempoix J-M, Humbert S, Humbert P,  
630 Sbidian E, Grange F, Bayrou O, Cathebras P, Morlat P, Epaulard O, Pavese P, Le Thi  
631 Huong D, Zoulim A, Stankovic K, Bachelez H, Smail A, Bachmeyer C, Granel B, Serratrice  
632 J, Brinchault G, Mekinian A, Costedoat-Chalumeau N, Bourgarit-Durand A, Puéchal X,  
633 Guillevin L, Píram M, Koné-Paut I, Fain O. 2016. Kawasaki disease in adults: Observations  
634 in France and literature review. *Autoimmunity Reviews* 15:242–249.
- 635 35. Grifoni A, Weiskopf D, Ramirez SI, Mateus J, Dan JM, Moderbacher CR, Rawlings SA,  
636 Sutherland A, Premkumar L, Jadi RS, Marrama D, Silva AM de, Frazier A, Carlin AF,  
637 Greenbaum JA, Peters B, Krammer F, Smith DM, Crotty S, Sette A. 2020. Targets of T  
638 Cell Responses to SARS-CoV-2 Coronavirus in Humans with COVID-19 Disease and  
639 Unexposed Individuals. *Cell* 181:1489-1501.e15.

640  
641

642 **Figures and Legends**

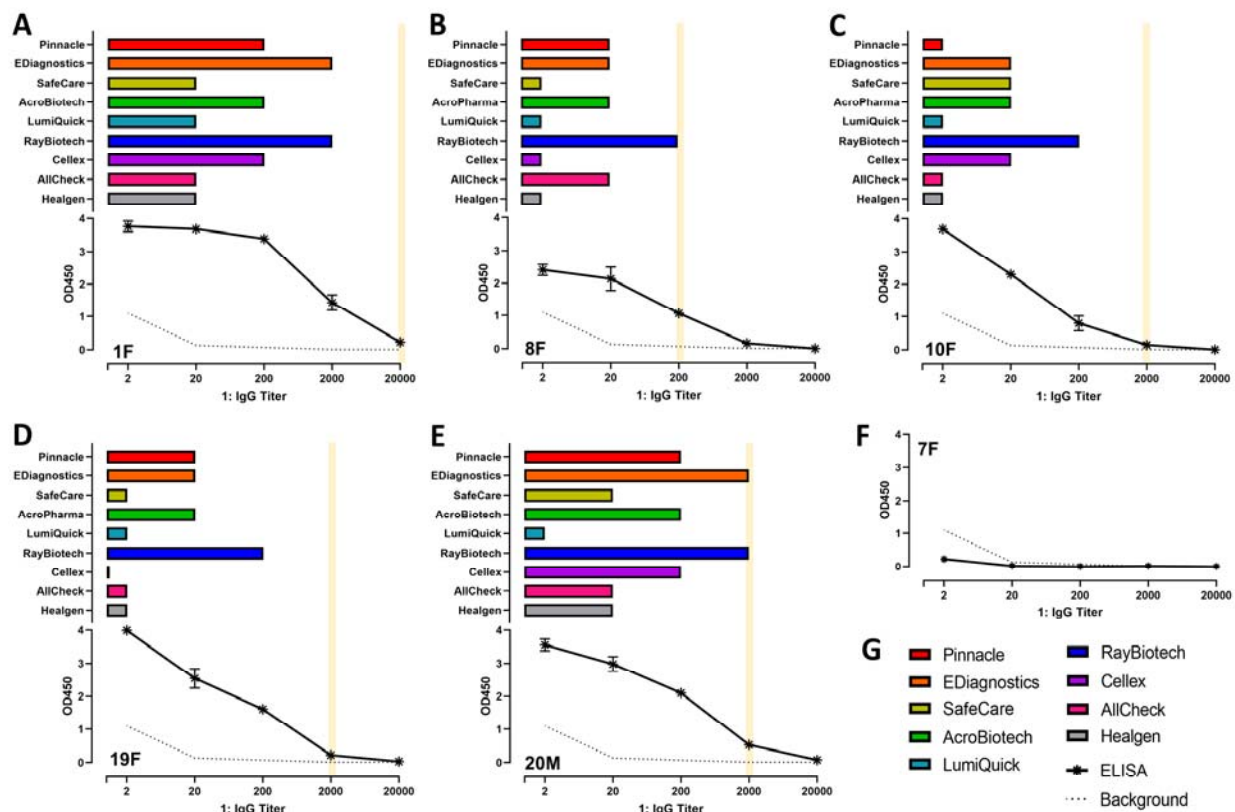

643  
 644 **Figure 1. Titer sensitivity of nine LFIs compared to a best practice ELISA reveals two**  
 645 **devices with high analytical sensitivity.** Negative control samples (N = 12) were used to  
 646 determine ELISA assay background. A) Patient 1F showed titers down to 1:20,000 above  
 647 background via ELISA. EDiagnostics LFI and RayBiotech LFI were the most sensitive for this  
 648 patient, showing positive scores to 1:2,000. B) Patient 8F showed titers down to 1:200 above  
 649 background via ELISA and RayBiotech LFI. C) Patient 10F showed titers down to 1:2,000 above  
 650 background via ELISA. RayBiotech LFI was the most sensitive for this patient, showing positive  
 651 scores to 1:200. D) Patient 19F showed titers down to 1:2,000 above background via ELISA.  
 652 RayBiotech LFI was the most sensitive for this patient, showing positive scores down to 1:200.  
 653 E) Patient 20F showed titers down to 1:2,000 above background via ELISA, EDiagnostics LFI,  
 654 and RayBiotech LFI. F) Patient 7F was negative at all dilutions. G) Legend utilized for panels A-  
 655 F.  
 656  
 657

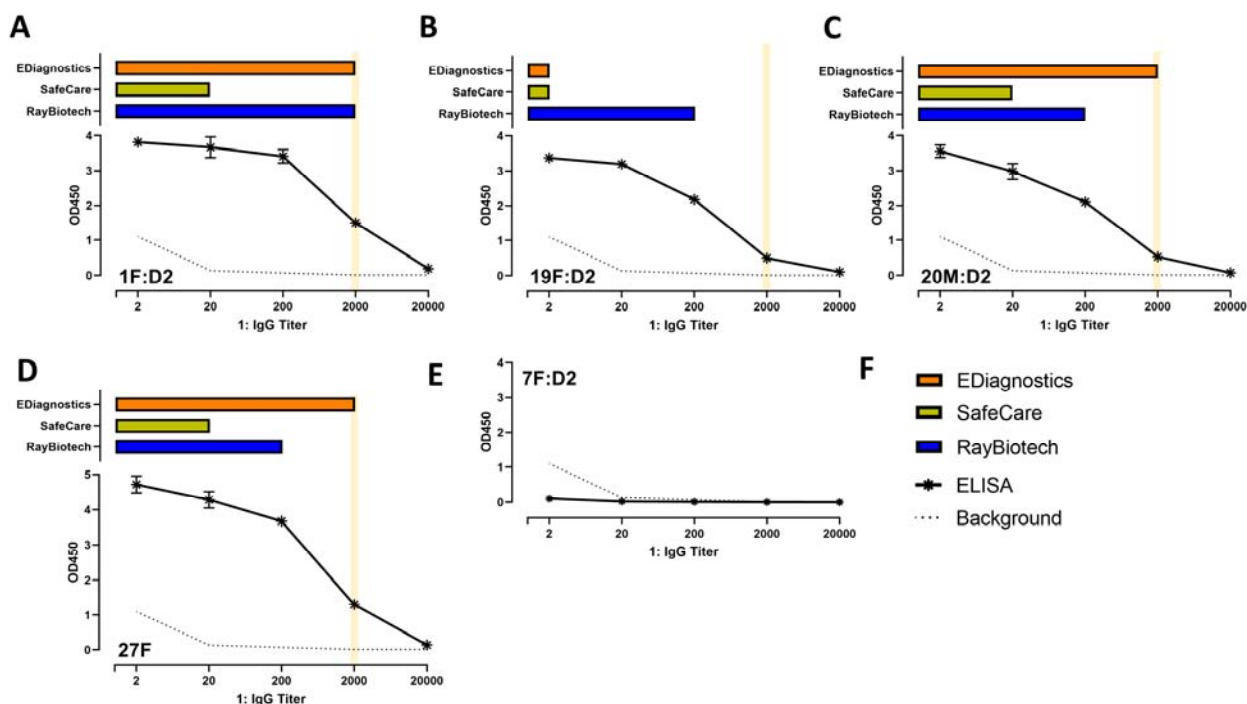

658  
 659 **Figure 2: Comparing titersensitivity of three LFIs, two high performing in the primary**  
 660 **screen and one average-performing in the primary screen, reveals continued high**  
 661 **analytical sensitivity of LFIs from EDiagnostics and RayBiotech.** Negative control samples  
 662 (N = 12) were used to determine ELISA assay background as in Figure 1. No significant  
 663 difference in titers between first and second patient's donations was observed. A) Patient 1F,  
 664 second donation sample, showed titers down to 1:2000 above background via ELISA,  
 665 EDiagnostics LFI, and RayBiotech LFI. B) Patient 19F, second donation sample, showed titers  
 666 down to 1:200 above background via ELISA and RayBiotech LFI. C) Patient 20M, second  
 667 donation sample, showed titers down to 1:2000 above background via ELISA and EDiagnostics  
 668 LFI. D) Patient 27F showed titers down to 1:2000 above background via ELISA and  
 669 EDiagnostics LFI. E) Patient 7F, second donation sample, was negative at all dilutions. F)  
 670 Legend utilized for panels A-E.  
 671  
 672

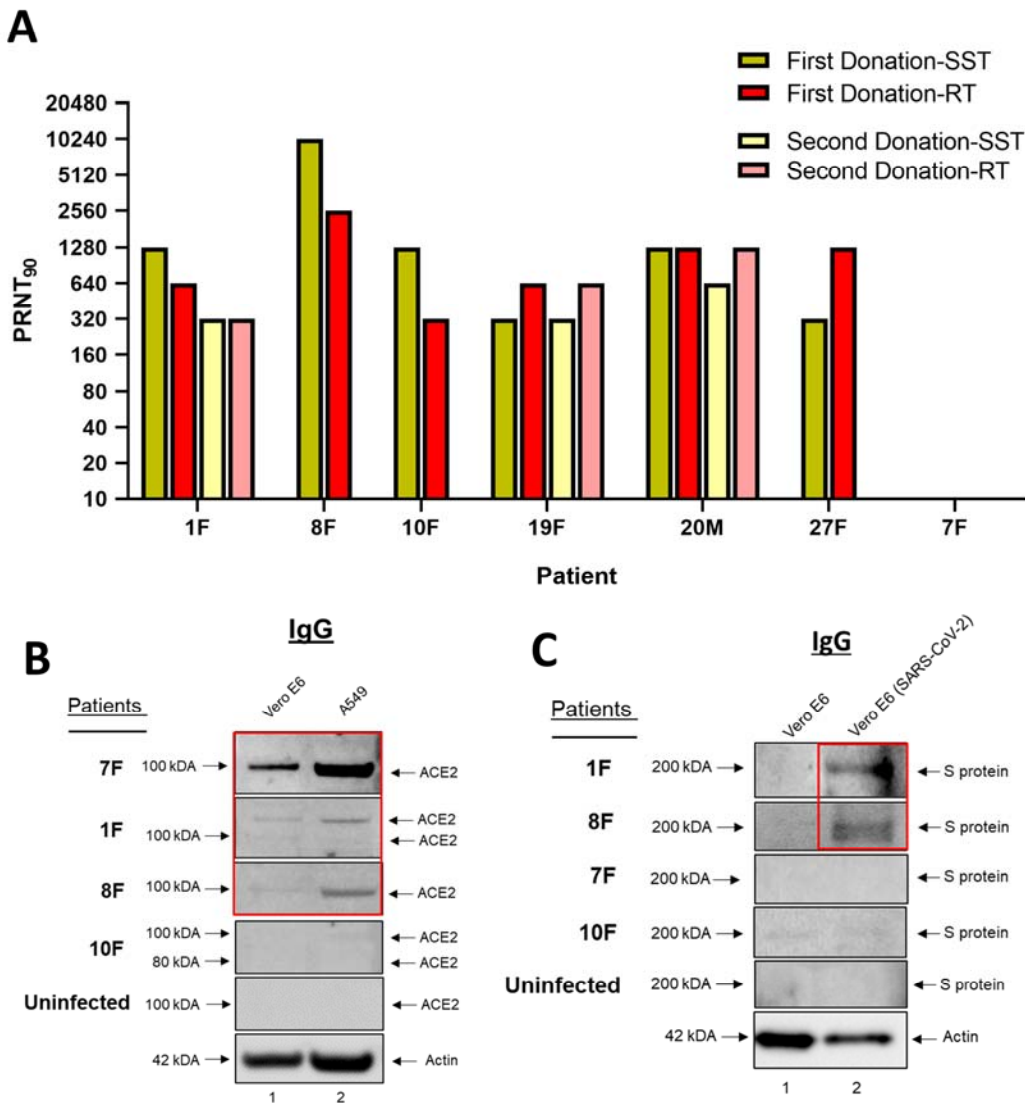

673  
674

675 **Figure 3. Viral neutralization, ELISA, and LFI negative patients may still harbor anti-**  
 676 **receptor antibodies that could affect clinical disease.** A) PRNT<sub>90</sub> values of PCR-confirmed  
 677 or clinically diagnosed COVID-19 patients shows high neutralizing titers only for patients who  
 678 also harbor anti-S or anti-N antibodies as determined via ELISA or LFI. Patient 7F did not inhibit  
 679 the virus. Both gel serum separator tubes (SST) and clot activator serum tubes (RT) showed  
 680 broadly similar titers for most patients. B) Patient 7F's first donation serum sample reacts  
 681 strongly with ACE2+ lysates, above both other infected and uninfected patients, suggesting the  
 682 presence of significant autoantibodies against ACE2. C) Patients 1F and 8F's first donation  
 683 samples show reactivity against the S protein from infected Vero cells, while 7F and the  
 684 uninfected control do not. While 10F's first donation sample showed anti-S responses via  
 685 ELISA, 10F does not show anti-S antibodies in this assay.  
 686

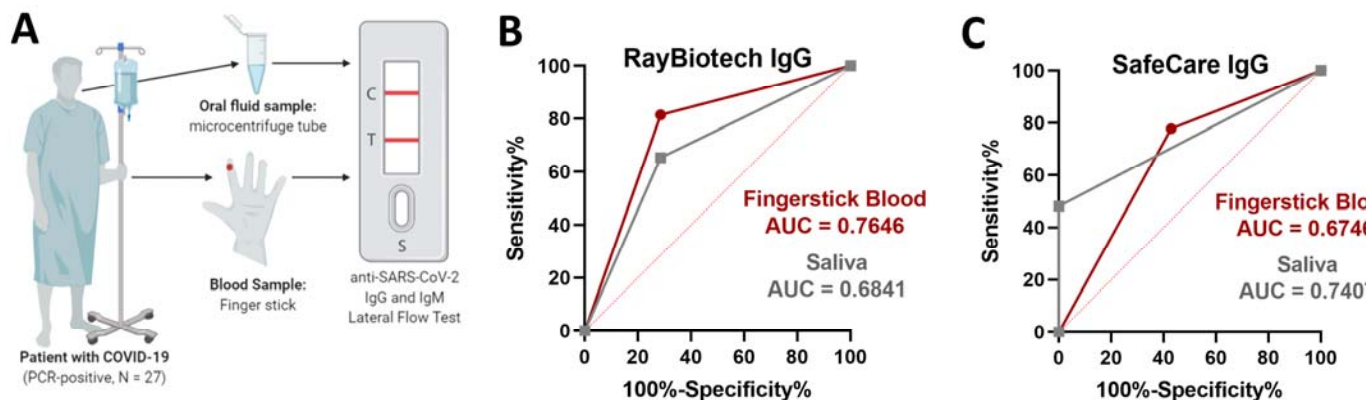

687  
688 **Figure 4. PCR-positive COVID-19 patients tested in the hospital at the point-of-care were**  
689 **correctly identified as positive more often by the RayBiotech test kit than by the**  
690 **SafeCare test kit using fingerstick blood.** A) Schematic of trial design. N=27 hospitalized  
691 COVID-19 patients greater than 10 days after start of symptoms were consented and donated a  
692 fingerstick blood sample and an oral fluid sample. Each patient's sample was tested against  
693 both the RayBiotech IgG and IgM test kits, and the SafeCare IgG/IgM test kit. B) RayBiotech  
694 correctly distinguished cases from controls (N=7 hospitalized, negative patients) with an AUC  
695 value of 0.7646 for fingerstick blood. Fingerstick blood was superior to saliva as hypothesized.  
696 C) SafeCare correctly distinguished cases from controls with an AUC of 0.6746 for fingerstick  
697 blood. Saliva was surprisingly superior to fingerstick blood, driven largely by the 100%  
698 specificity value. Sensitivity with saliva was poor (48%).  
699

700 **Tables**

701 Table 1. Patient Characteristics

702

<b>PATIENT #</b>	<b>COVID-19 DIAGNOSIS: PCR-CONFIRMED, CLINICAL, OR NONE</b>	<b>SYMPTOMS: NONE, WEAK, MODERATE</b>	<b>TIME BETWEEN FIRST AND SECOND DONATIONS</b>
<b>1F</b>	RT-PCR Confirmed	Moderate	3 weeks
<b>7F</b>	Clinical Diagnosis: Based on Symptoms	Mild	6 weeks
<b>8F</b>	RT-PCR Confirmed	Moderate	N/A
<b>10F</b>	RT-PCR Confirmed	Moderate	N/A
<b>19F</b>	Clinical Diagnosis: Based on symptoms and RT-PCR+ family members	Mild	3 weeks
<b>20M</b>	RT-PCR Confirmed	Moderate	3 weeks
<b>27F</b>	RT-PCR Confirmed	Moderate	N/A

703

704 **Table 2: Concordance between LFI readers.** Fleiss' kappa, Krippendorff's alpha, and percent  
705 agreement values describing reader agreement by test. All samples (both IgM and IgG results)  
706 are considered.

707  
708

<b>MANUFACTURER</b>	<b>FLEISS' KAPPA</b>	<b>KRIPPENDORFF'S ALPHA</b>	<b>PERCENT AGREEMENT</b>
PINNACLE	0.868	0.869	0.922
EDIAGNOSTICS	0.500	0.501	0.691
SAFECARE	0.747	0.748	0.880
ACROBIOTECH	0.801	0.802	0.900
LUMIQUICK	0.916	0.917	0.967
RAYBIOTECH	0.399	0.401	0.611
CELLEX	0.587	0.590	0.776
ALLCHECK	0.650	0.652	0.822
HEALGEN	0.648	0.650	0.800
<b>ALL TESTS</b>	<b>0.659</b>	<b>0.671</b>	<b>0.800</b>

709  
710  
711  
712



713 **Supplementary Figures**

714

715 **Supplementary Table 1:** Raw patient LFI score data. (Excel sheet of raw data will be uploaded  
716 upon submission)

717

718

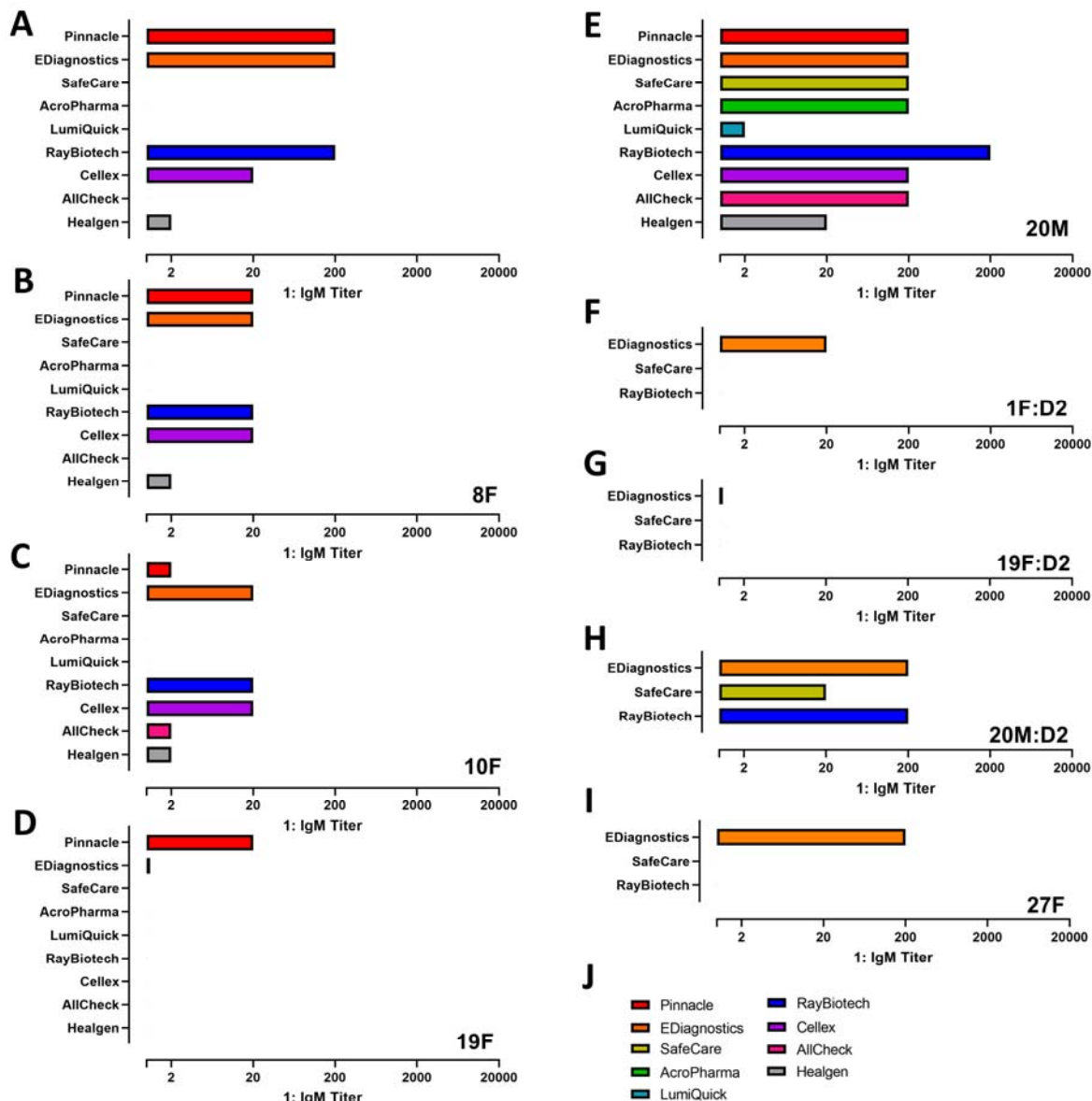

719  
 720 **Supplementary Figure 1. Analytical sensitivity analysis of lateral flow immunoassay**  
 721 **devices for IgM with 6 PCR-positive/ELISA-positive/viral neutralization positive patients,**  
 722 **including second donations from patients 1F, 19F, and 20M, reveals reduced IgM titers**  
 723 **from first donation as expected.** A) Patient 1F showed positive results out to 1:200 dilution  
 724 with three LFIs. B) Patient 8F showed positive results out to 1:20 dilution with four LFIs. C)  
 725 Patient 10F showed positive results out to 1:20 dilution with three LFIs. D) Patient 19F showed  
 726 positive results out to 1:20 dilution with one LFI. E) Patient 20M showed positive results out to  
 727 1:2000 dilution with one LFI. F) Patient 1F, second draw, showed positive results out to 1:20  
 728 with one LFI. G) Patient 19F, second draw, was only positive for IgM with neat serum using one  
 729 LFI. H) Patient 20M, second draw, showed positive results out to 1:200 with two LFIs. I) Patient  
 730 27F showed positive results out to 1:200 with one LFI. J) Legend for panels A-I

731  
 732  
 733

734 **Supplementary Table 2. Concordance between LFI readers.** Fleiss' kappa, Krippendorff's  
735 alpha, and percent agreement values describing reader agreement by test. IgG only readings  
736 are included.  
737

<b>MANUFACTURER</b>	<b>FLEISS' KAPPA</b>	<b>KRIPPENDORFF'S ALPHA</b>	<b>PERCENT AGREEMENT</b>
PINNACLE	0.886	0.888	0.933
EDIAGNOSTICS	0.428	0.431	0.679
SAFECARE	0.776	0.777	0.870
ACROBIOTECH	0.799	0.802	0.889
LUMIQUICK	0.954	0.954	0.978
RAYBIOTECH	0.278	0.282	0.586
CELLEX	0.697	0.905	0.821
ALLCHECK	0.873	0.874	0.933
HEALGEN	0.741	0.744	0.856
<b>ALL TESTS</b>	0.683	0.692	0.812

738  
739  
740  
741

742 **Supplementary Table 3. Concordance between LFI readers.** Fleiss' kappa, Krippendorff's  
743 alpha, and percent agreement values describing reader agreement by test. IgM only readings  
744 are included.  
745

<b>MANUFACTURER</b>	<b>FLEISS' KAPPA</b>	<b>KRIPPENDORFF'S ALPHA</b>	<b>PERCENT AGREEMENT</b>
PINNACLE	0.850	0.852	0.911
EDIAGNOSTICS	0.533	0.535	0.704
SAFECARE	0.560	0.563	0.889
ACROBIOTECH	0.674	0.678	0.911
LUMIQUICK	0.815	0.817	0.956
RAYBIOTECH	0.376	0.380	0.636
CELLEX	0.3942	0.402	0.731
ALLCHECK	0.323	0.330	0.711
HEALGEN	0.553	0.558	0.744
<b>ALL TESTS</b>	0.600	0.6003	0.798

746

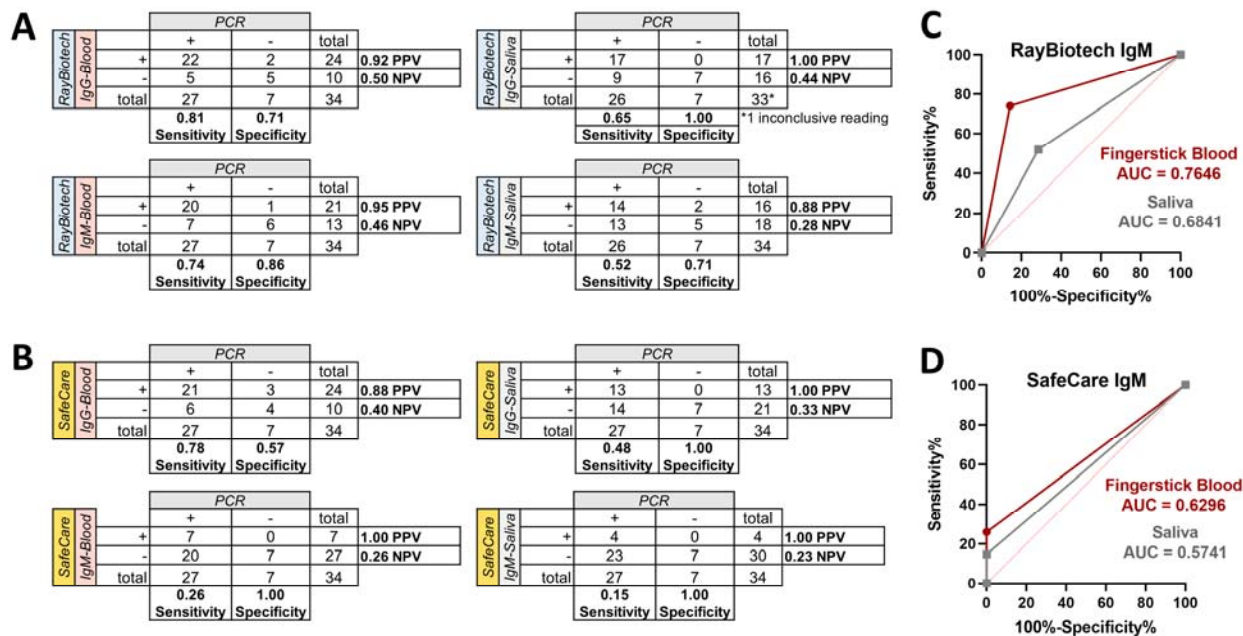

747  
 748 **Supplementary Figure 2.** Sensitivity, specificity, PPV and NPV for clinical analysis of  
 749 RayBiotech and SafeCare LFI devices. A) 2 X 2 tables for RayBiotech IgG and IgM lateral flow  
 750 devices when tested on fingerstick blood and saliva. B) 2 x 2 tables for SafeCare IgG and IgM  
 751 lateral flow devices when tested on fingerstick blood and saliva. C) ROC curve analysis for  
 752 RayBiotech IgM device. D) ROC curve analysis for SafeCare IgM device.

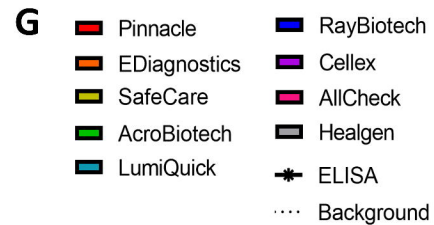
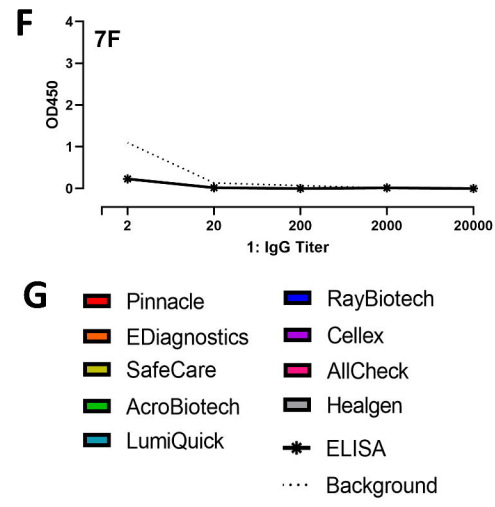
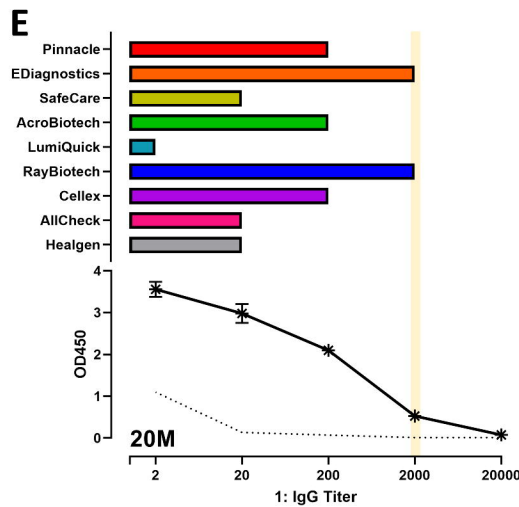
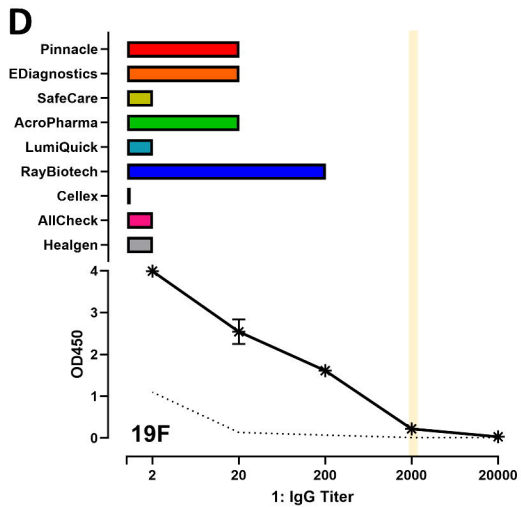
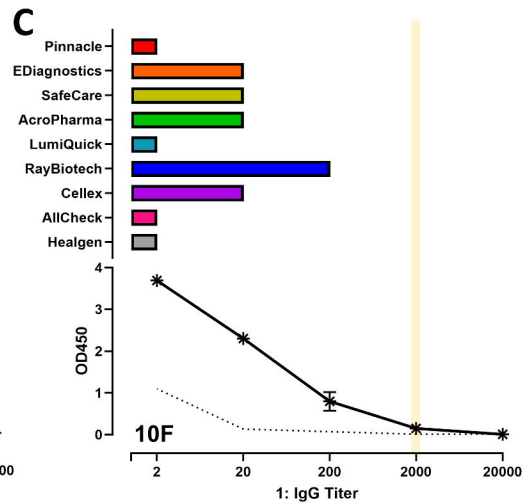
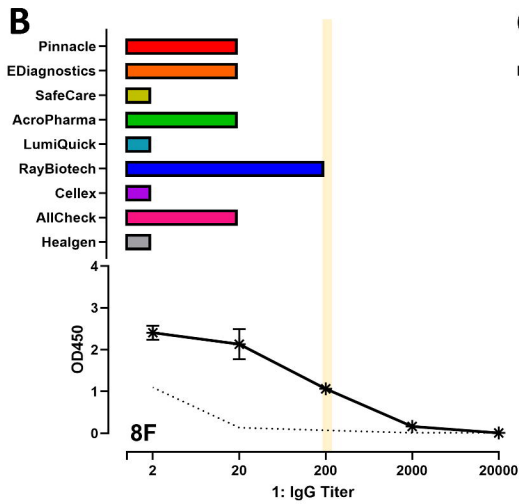
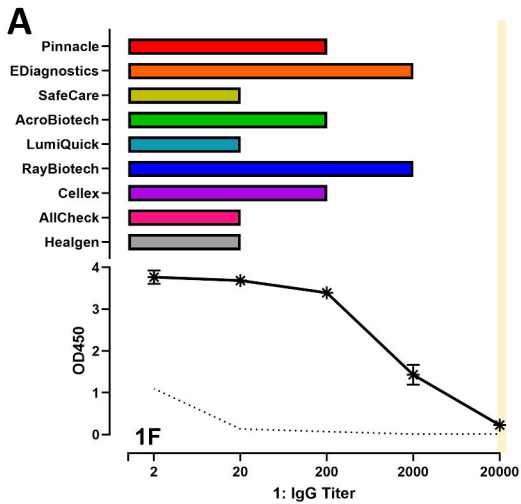

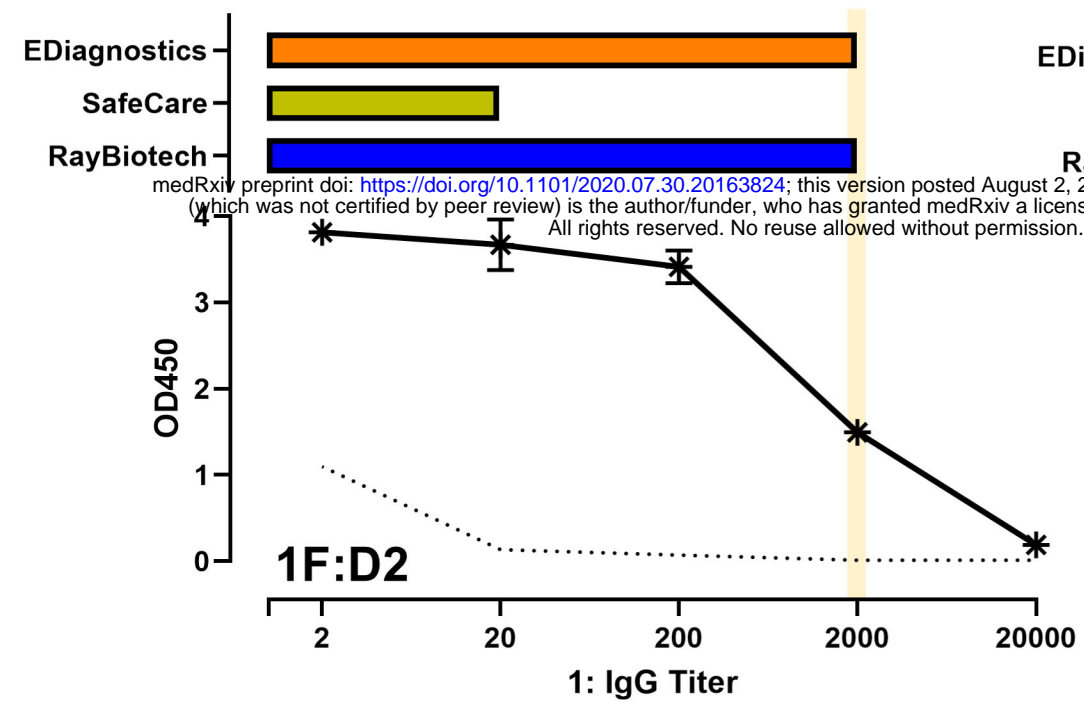
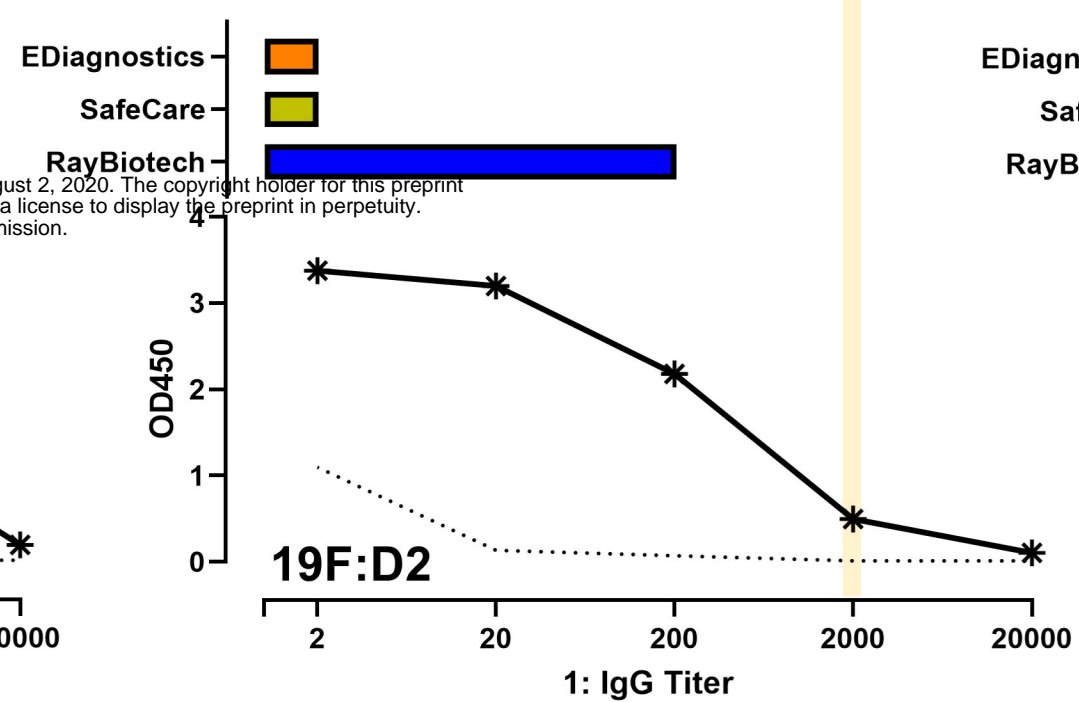
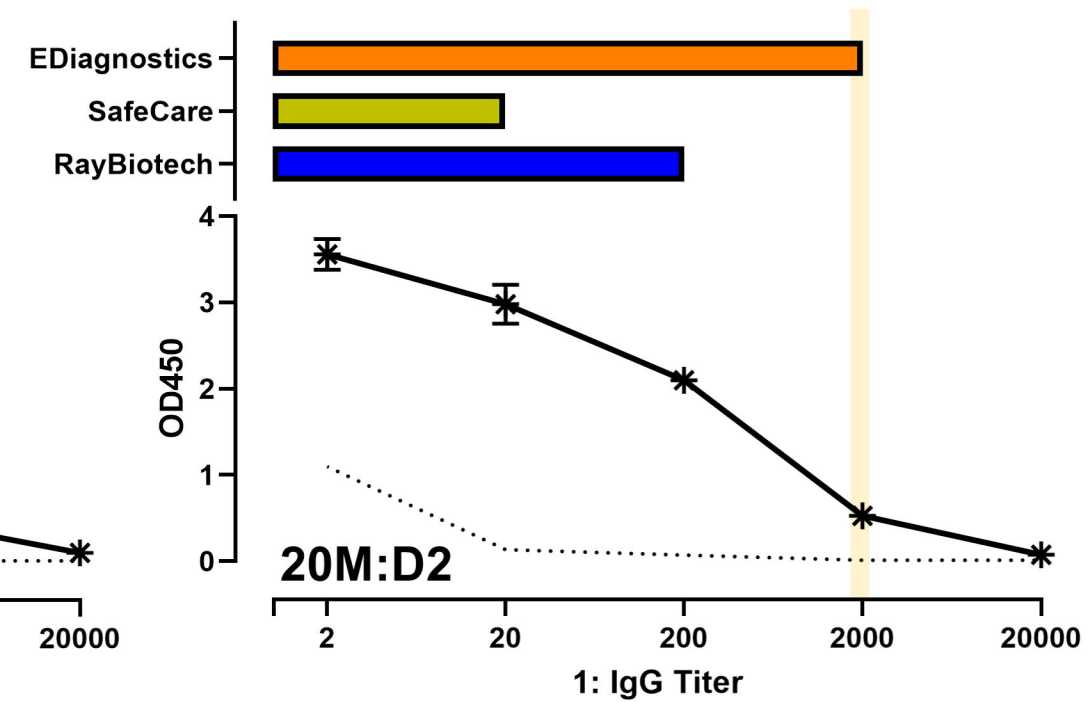
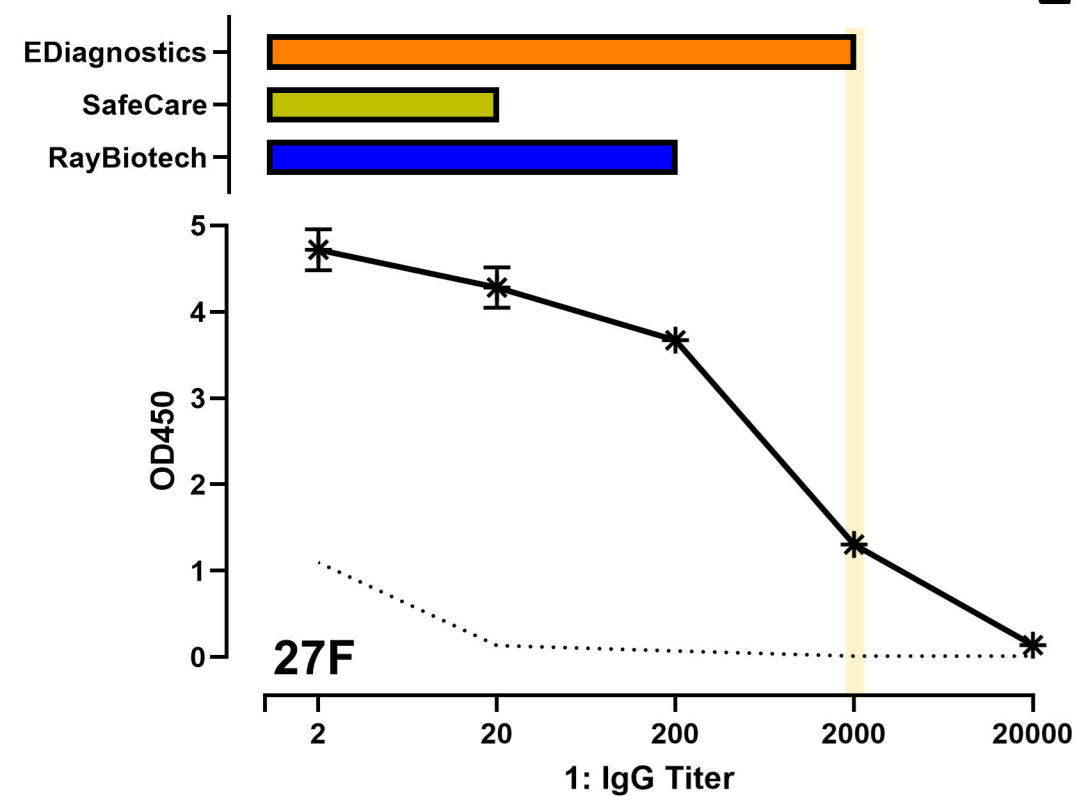
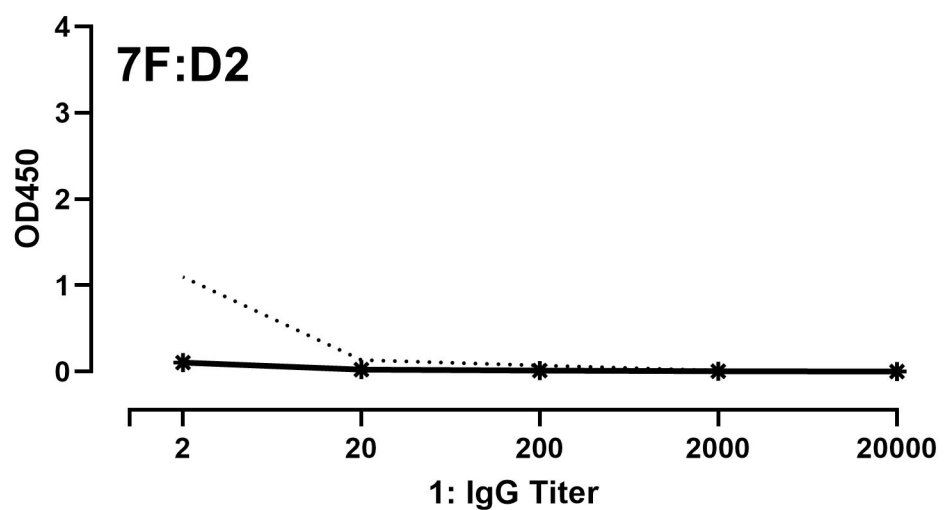
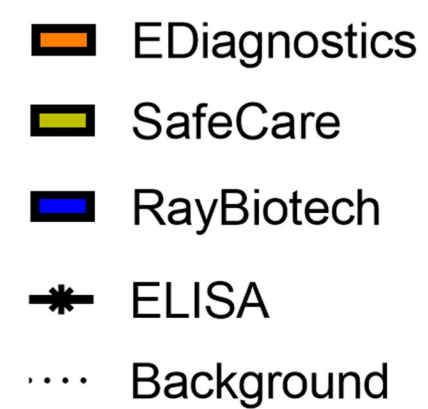
**A****B****C****D****E****F**

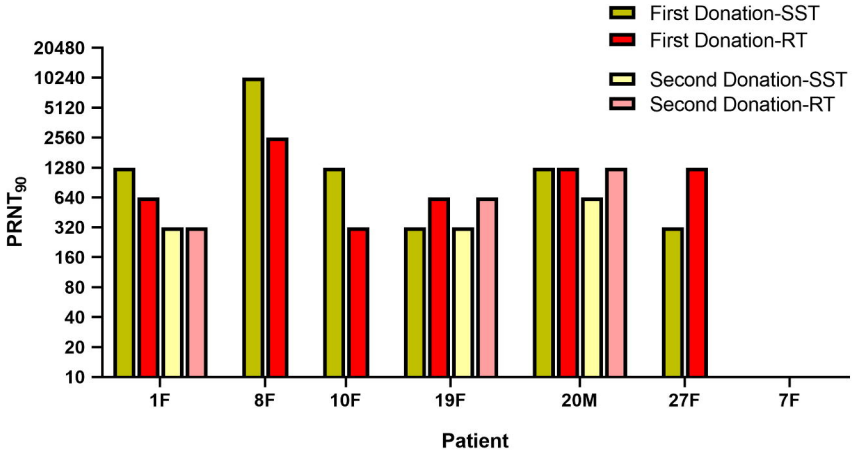
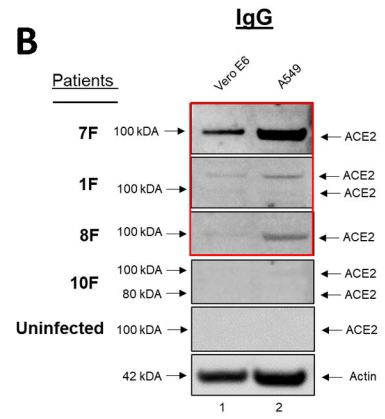
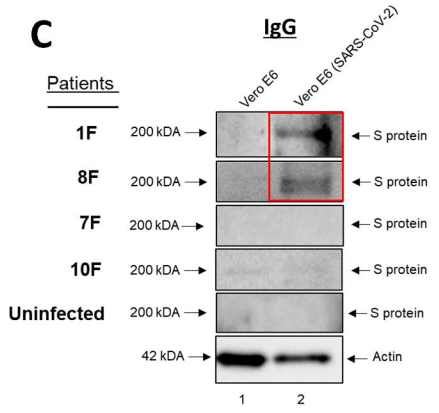
**A****B****C**



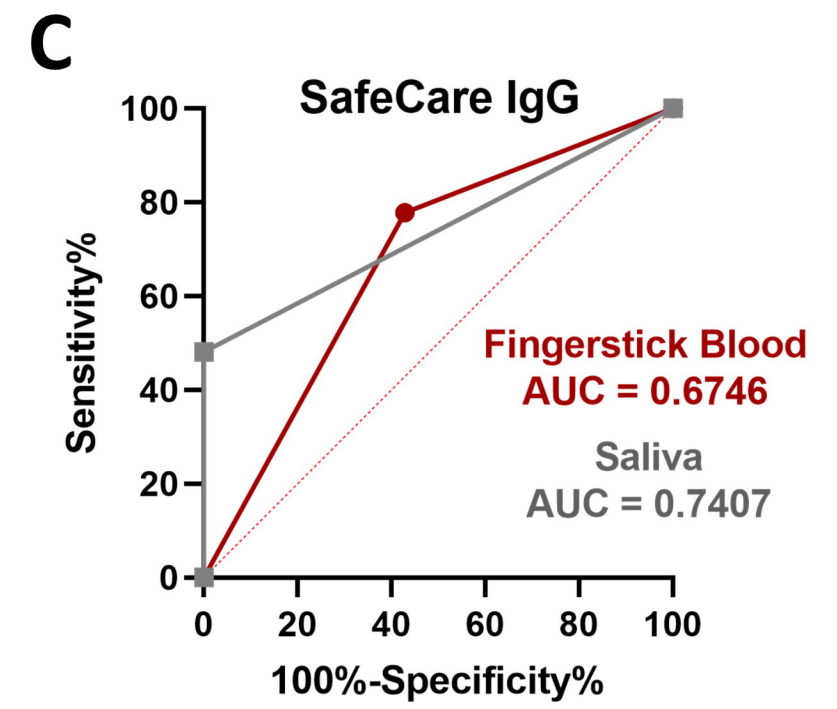
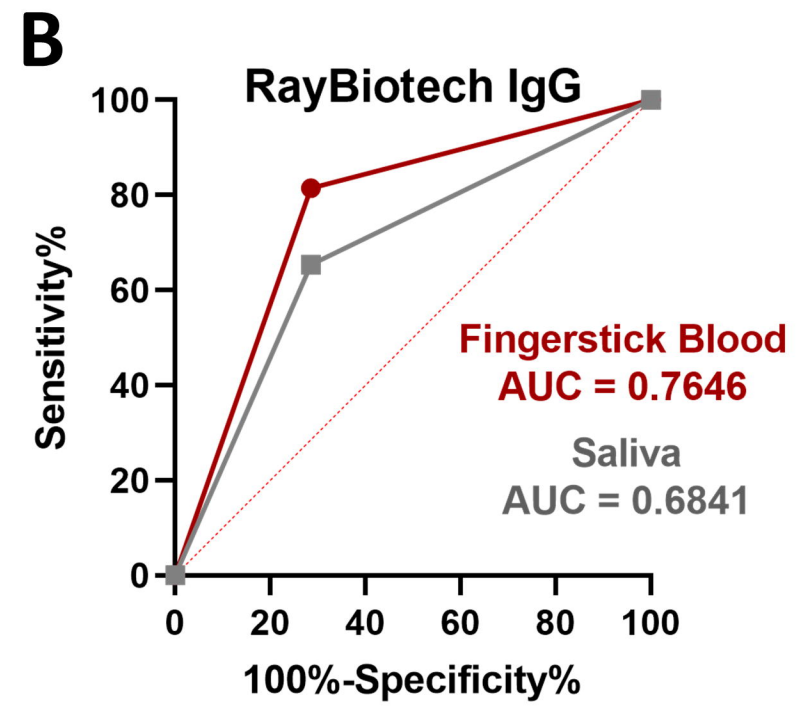
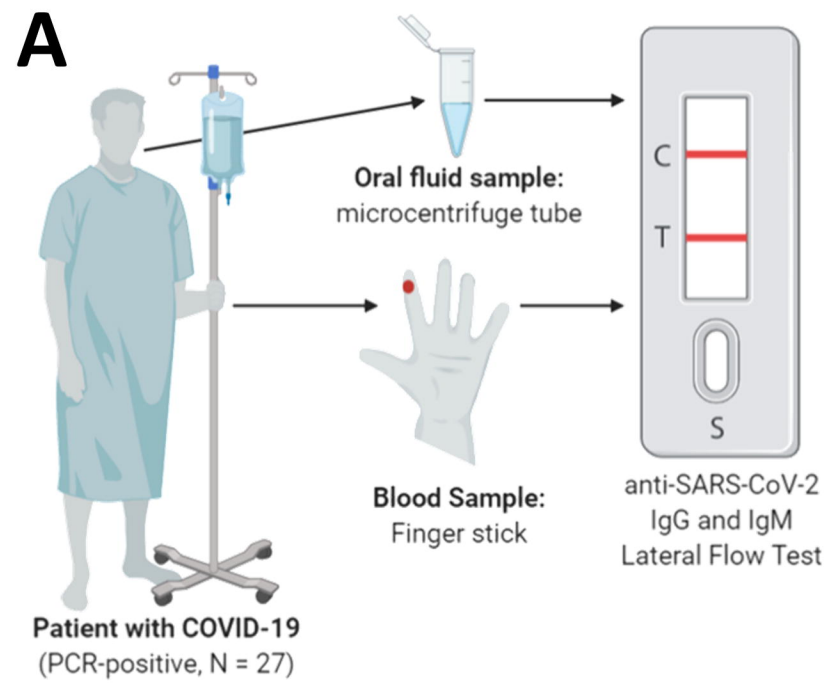

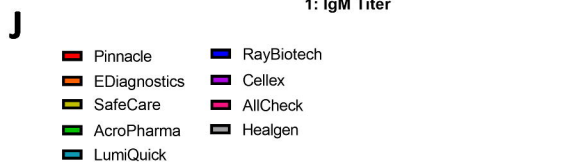
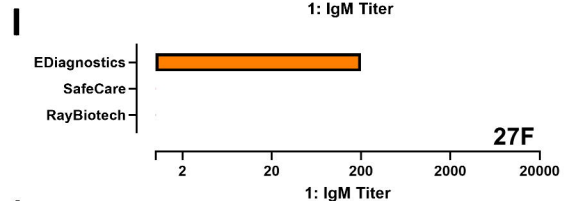
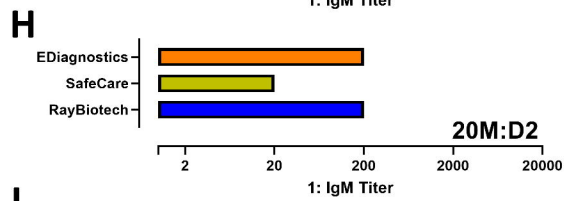
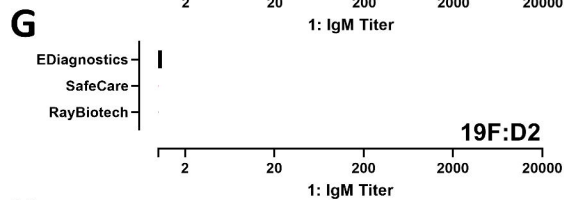
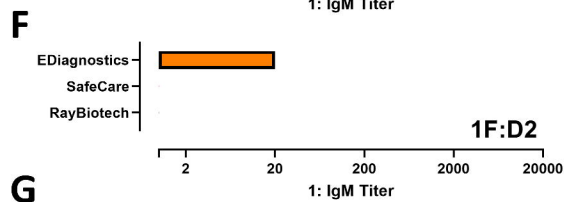
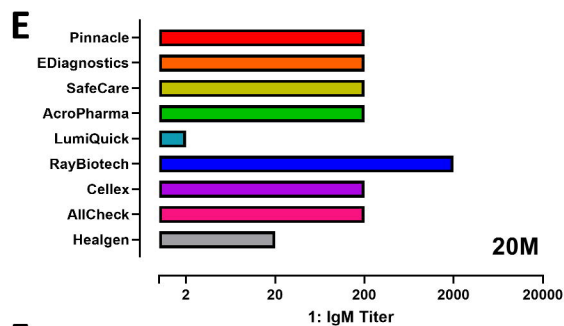
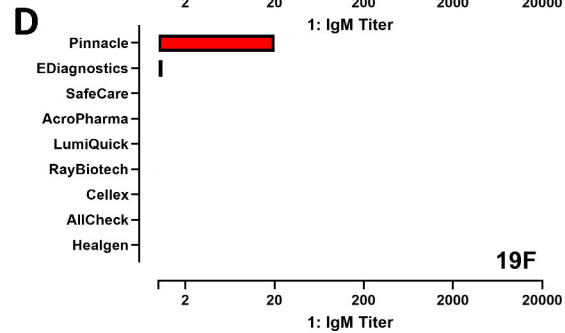
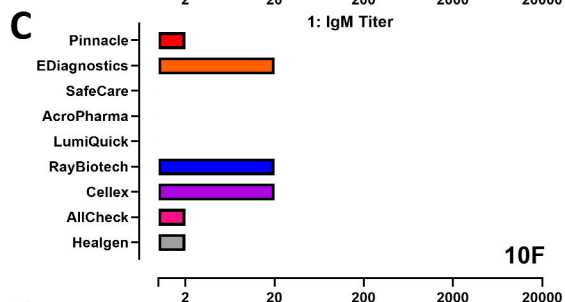
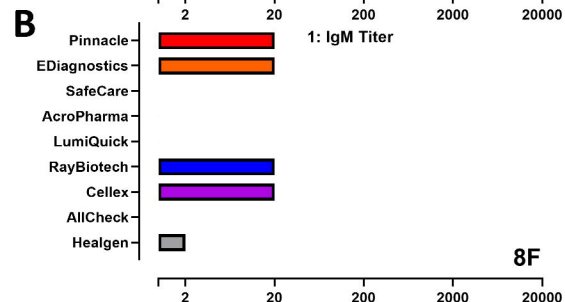
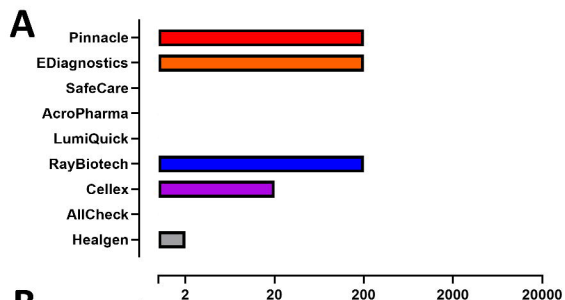

**A**

		PCR		total	
		+	-		
RayBiotech IgG-Blood	+	22	2	24	<b>0.92 PPV</b>
	-	5	5	10	<b>0.50 NPV</b>
	total	27	7	34	
		<b>0.81</b>	<b>0.71</b>		
		<b>Sensitivity</b>	<b>Specificity</b>		

		PCR		total	
		+	-		
RayBiotech IgG-Saliva	+	17	0	17	<b>1.00 PPV</b>
	-	9	7	16	<b>0.44 NPV</b>
	total	26	7	33*	
		<b>0.65</b>	<b>1.00</b>	*1 inconclusive reading	
		<b>Sensitivity</b>	<b>Specificity</b>		

		PCR		total	
		+	-		
RayBiotech IgM-Blood	+	20	1	21	<b>0.95 PPV</b>
	-	7	6	13	<b>0.46 NPV</b>
	total	27	7	34	
		<b>0.74</b>	<b>0.86</b>		
		<b>Sensitivity</b>	<b>Specificity</b>		

		PCR		total	
		+	-		
RayBiotech IgM-Saliva	+	14	2	16	<b>0.88 PPV</b>
	-	13	5	18	<b>0.28 NPV</b>
	total	26	7	34	
		<b>0.52</b>	<b>0.71</b>		
		<b>Sensitivity</b>	<b>Specificity</b>		

**B**

		PCR		total	
		+	-		
SafeCare IgG-Blood	+	21	3	24	<b>0.88 PPV</b>
	-	6	4	10	<b>0.40 NPV</b>
	total	27	7	34	
		<b>0.78</b>	<b>0.57</b>		
		<b>Sensitivity</b>	<b>Specificity</b>		

		PCR		total	
		+	-		
SafeCare IgG-Saliva	+	13	0	13	<b>1.00 PPV</b>
	-	14	7	21	<b>0.33 NPV</b>
	total	27	7	34	
		<b>0.48</b>	<b>1.00</b>		
		<b>Sensitivity</b>	<b>Specificity</b>		

		PCR		total	
		+	-		
SafeCare IgM-Blood	+	7	0	7	<b>1.00 PPV</b>
	-	20	7	27	<b>0.26 NPV</b>
	total	27	7	34	
		<b>0.26</b>	<b>1.00</b>		
		<b>Sensitivity</b>	<b>Specificity</b>		

		PCR		total	
		+	-		
SafeCare IgM-Saliva	+	4	0	4	<b>1.00 PPV</b>
	-	23	7	30	<b>0.23 NPV</b>
	total	27	7	34	
		<b>0.15</b>	<b>1.00</b>		
		<b>Sensitivity</b>	<b>Specificity</b>		

**C**

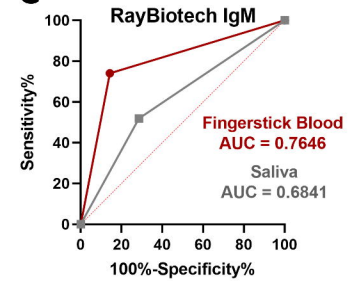

**D**

