

COVID-19 Chest Drain Filter Modification Instructions for Use

Contents





1. Intended Use.....	1
2. Preparing the Filter Connector Assembly	2
3. Setting Up the Chest Drain.....	3
4. Replacing the Filter	4
5. Replacing the Filter and Filter Connector Assembly	4
6. Important Information.....	5
7. Warnings.....	5
8. Incident Reporting	5
9. Manufacturer Details.....	5



1. Intended Use

To reduce the risk of viral particle expulsion from a R54500 Rocket Chest Drainage Bottle in the management of pneumothorax in patients suspected or confirmed infected with COVID-19.

2. Preparing the Filter Connector Assembly

			
Rocket Chest Drain Tubing Set, Ref R54502	8.0mm Portex Tracheal Tube, Ref 100/199/080	Sterile Scissors or Scalpel	Sterile Ruler

- 2.1. On a sterile tray, remove the Rocket Chest Drain Tubing Set from its packaging.
- 2.2. Using the Sterile Scissors or Scalpel and the Sterile Ruler, cut a 5cm section of tubing from the end of the Tubing Set.
- 2.3. Verify that the cut length of tubing is between 4.5-5.5cm (if otherwise, repeat step 2.2) then dispose of the remainder of the Tubing Set.
- 2.4. Remove the 8.0mm Portex Tracheal Tube from its packaging.
- 2.5. Remove the blue connector piece and dispose of the rest of the Tracheal Tube.
- 2.6. Attach the cut piece of tube to the blue connector. Ensure the tube is pushed to the end of the blue connector so that there is no more than a 5mm gap (see Figure 2A).

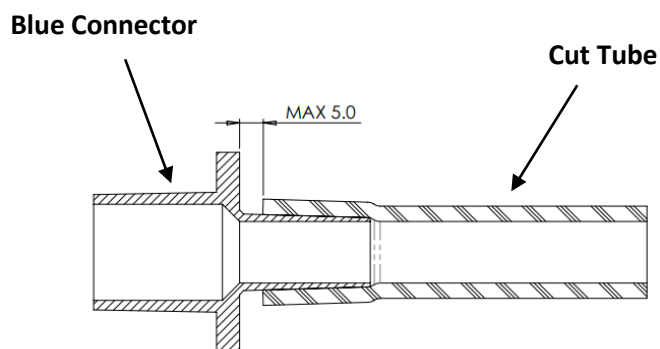

Figure 2A: Push the cut tube onto the blue connector so that there is no more than a 5.0mm gap between the end of the tube and the connector.

3. Setting Up the Chest Drain



- 3.1. Remove the Rocket Chest Drainage Bottle from its packaging.
- 3.2. Remove the green cap from the nozzle on the top of the Bottle.
- 3.3. Remove the Teleflex Humid-Vent Filter Compact from its packaging and firmly attach the opaque end of the Filter to the blue part of the Filter Connector Assembly.
- 3.4. Firmly push the tube end of the Filter Connector Assembly onto the exposed nozzle on the Bottle, so that only one of the rings on the nozzle is visible (see Figure 3A).
- 3.5. Proceed with normal use of the Rocket Chest Drainage Bottle.

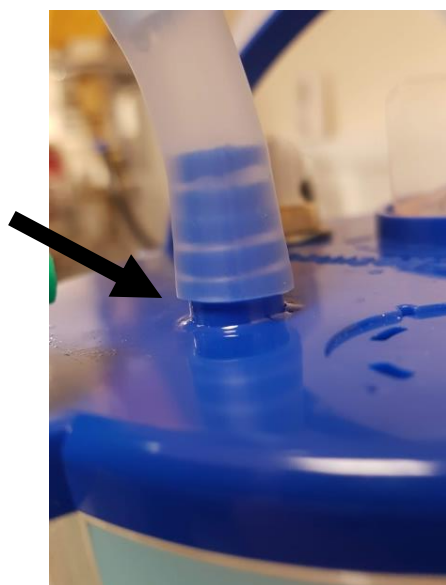
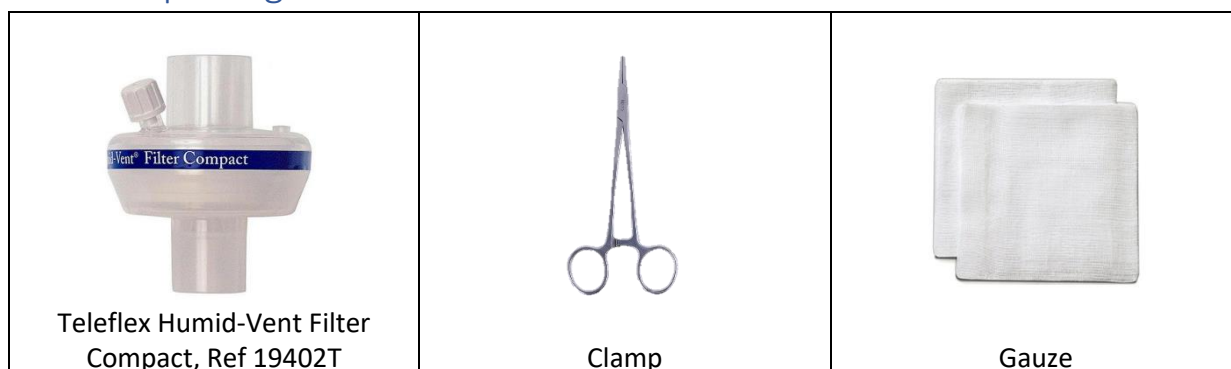

Figure 3A. Push the Filter Connector Assembly firmly onto the lowest ring of nozzle.



Figure 3B. The assembled COVID-19 Chest Drain Filter Modification.

4. Replacing the Filter



- 4.1. Wrap gauze around the exposed tube and apply a clamp, taking care to ensure that the tube is fully occluded.
- 4.2. Remove the old Filter by firmly holding onto the blue connector and pulling on the Filter. If the Filter cannot be easily removed, see Section 5.
- 4.3. Dispose of the Filter safely according to local clinical waste protocols.
- 4.4. Remove a new Filter from its packaging and firmly fit it to the Connector Assembly.
- 4.5. Remove the clamp and inspect the tube for damage. If the tube is visibly damaged or kinked the Filter Connector Assembly should be replaced as per Section 5.

5. Replacing the Filter and Filter Connector Assembly

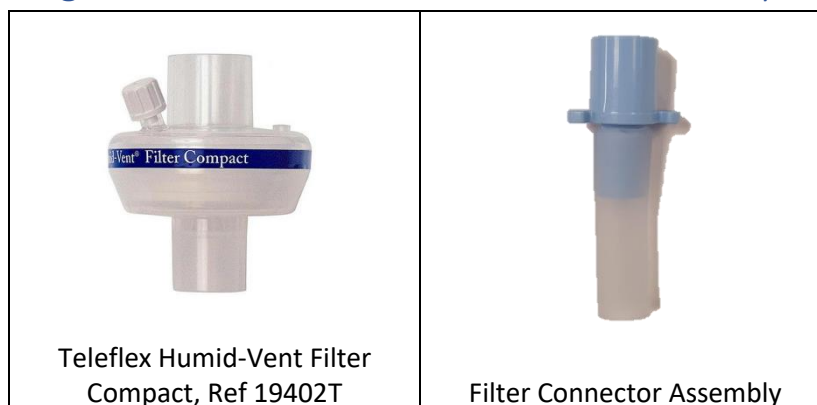

- 5.1. Prepare a new Filter Connector Assembly as per Section 2.
- 5.2. Remove the new Teleflex Humid-Vent Filter Compact from its sterile packaging and firmly attach the opaque end of the Filter to the blue part of the Filter Connector Assembly.
- 5.3. Disconnect the old Filter and Filter Connector Assembly from the Bottle nozzle.
- 5.4. Quickly replace with the new Filter and Filter Connector Assembly, firmly pushing the tube onto the exposed nozzle so that only one of the rings on the nozzle is visible.
- 5.5. Dispose of the Filter and Filter Connector Assembly according to local clinical waste protocols.

6. Important Information

- 6.1. Replace the filter after 24 hours of use (See Replacing the Filter Section 4).
- 6.2. Wear appropriate PPE for each procedure in this document as per local guidelines.
- 6.3. Regularly check that the connections between the Filter, Filter Connector Assembly and Nozzle remain tight and secure, and record on the chest drain chart.
- 6.4. Ensure that the cap on the Teleflex Humid-Vent Filter Compact remains closed at all times.
- 6.5. Take care to minimise swaying or knocking of the Bottle.
- 6.6. Regularly check that the Filter and tube are not visibly kinked or occluded. If kinking or occlusion is detected, replace the Filter Connector Assembly and/or Filter as necessary.
- 6.7. If the Filter comes into contact with liquid, or appears to be visibly saturated with liquid, the Filter and Filter Connector Assembly should be replaced.

7. Warnings

- 7.1. For use by a medical professional only.
- 7.2. Only use for the Intended Use as specified in Section 1.
- 7.3. The device is manufactured under the MDR Health Institute Exemption and is not approved for use outside NHS Greater Glasgow and Clyde.
- 7.4. All parts are single use.
- 7.5. This modification is not designed to prevent the release of viral particles via the pressure release valve.
- 7.6. Follow local guidelines for infection control and safe disposal of parts.

8. Incident Reporting

Any serious incident that has occurred in relation to this device should be logged in Datix and reported to the manufacturer (below).

9. Manufacturer Details

Medical Devices Unit, NHS Greater Glasgow and Clyde
West Glasgow Ambulatory Care Hospital
Dalnair Street
Yorkhill
Glasgow
G3 8SJ

Email: gg-uhb.mdu@nhs.net

The manufacturers welcome feedback on this device modification. To provide feedback, please visit the website below and complete the COVID-19 Chest Drain Filter Modification Feedback Form.

<https://medicaldevicesunit.org/covid>